

# LoadLIFTER™ 5000

by AIR LIFT®

## **Kits 57204, 57211**

***Chevrolet Silverado 1500  
and GMC Sierra 1500***

***Two and Four Wheel Drive***



## **INSTALLATION GUIDE**

For maximum effectiveness and safety, please read these instructions completely before proceeding with installation.

*Failure to read these instructions can result in an incorrect installation.*

# TABLE OF CONTENTS

<b>Introduction</b> .....	<b>2</b>
Important Safety Notice .....	2
Notation Explanation .....	2
<b>Installation Diagrams</b> .....	<b>3</b>
<b>Hardware and Tools Lists</b> .....	<b>5</b>
<b>Installing the LoadLifter 5000 System</b> .....	<b>6</b>
Getting Started .....	6
Assembling the Air Spring Assemblies .....	10
Installing the Air Spring Assemblies .....	11
Lower Bracket Installation .....	14
Installing the Air Lines .....	14
Installing the Hose Heat Shield .....	16
Checking for Leaks .....	16
Fixing Leaks .....	16
Left and Right Hand Installation Photos .....	17
<b>Before Operating</b> .....	<b>18</b>
Installation Checklist .....	18
Post-Installation Checklist .....	18
<b>Product Use, Maintenance and Servicing</b> .....	<b>19</b>
Minimum and Maximum Pressure .....	19
Maintenance Guidelines .....	19
Troubleshooting Guide .....	19
Frequently Asked Questions .....	20
Tuning the Air Pressure .....	20
Guidelines for Adding Air .....	21
<b><u><a href="#">Choosing the Right On-Board Air Compressor System</a></u></b> .....	<b>23</b>
<b>Limited Warranty and Return Policy</b> .....	<b>24</b>
<b>Replacement Information</b> .....	<b>25</b>
<b>Contact Information</b> .....	<b>25</b>

# Introduction

The purpose of this publication is to assist with the installation, maintenance and troubleshooting of the LoadLifter 5000 air spring kit. LoadLifter 5000 utilizes sturdy, reinforced, commercial grade single or double, depending on the kit, convolute bellows. The bellows are manufactured like a tire with layers of rubber and cords that control growth. LoadLifter 5000 kits are recommended for most 3/4 and 1 ton pickups and SUVs with leaf springs and provide up to 5,000 lbs. of load leveling support with air adjustability from 5-100 PSI. The kits are used in motor home rear applications and various front applications where leaf springs are used.

It is important to read and understand the entire installation guide before beginning installation or performing any maintenance, service or repair. The information here includes a hardware list, tool list, step-by-step installation information, maintenance guidelines and operating tips.

## IMPORTANT SAFETY NOTICE

The installation of this kit does not alter the Gross Vehicle Weight Rating (GVWR) or payload of the vehicle. Check your vehicle's owner's manual and do not exceed the maximum load listed for your vehicle.

**Gross Vehicle Weight Rating:** The maximum allowable weight of the fully loaded vehicle (including passengers and cargo). This number — along with other weight limits, as well as tire, rim size and inflation pressure data — is shown on the vehicle's Safety Compliance Certification Label.

**Payload:** The combined, maximum allowable weight of cargo and passengers that the truck is designed to carry. Payload is GVWR minus the Base Curb Weight.

## NOTATION EXPLANATION

Hazard notations appear in various locations in this publication. Information which is highlighted by one of these notations must be observed to help minimize risk of personal injury or possible improper installation which may render the vehicle unsafe. Notes are used to help emphasize areas of procedural importance and provide helpful suggestions. The following definitions explain the use of these notations as they appear throughout this guide.

INDICATES IMMEDIATE HAZARDS WHICH WILL RESULT IN SEVERE PERSONAL INJURY OR DEATH.

INDICATES HAZARDS OR UNSAFE PRACTICES WHICH COULD RESULT IN SEVERE PERSONAL INJURY OR DEATH.

INDICATES HAZARDS OR UNSAFE PRACTICES WHICH COULD RESULT IN DAMAGE TO THE MACHINE OR MINOR PERSONAL INJURY.

 **DANGER**

 **WARNING**

 **CAUTION**

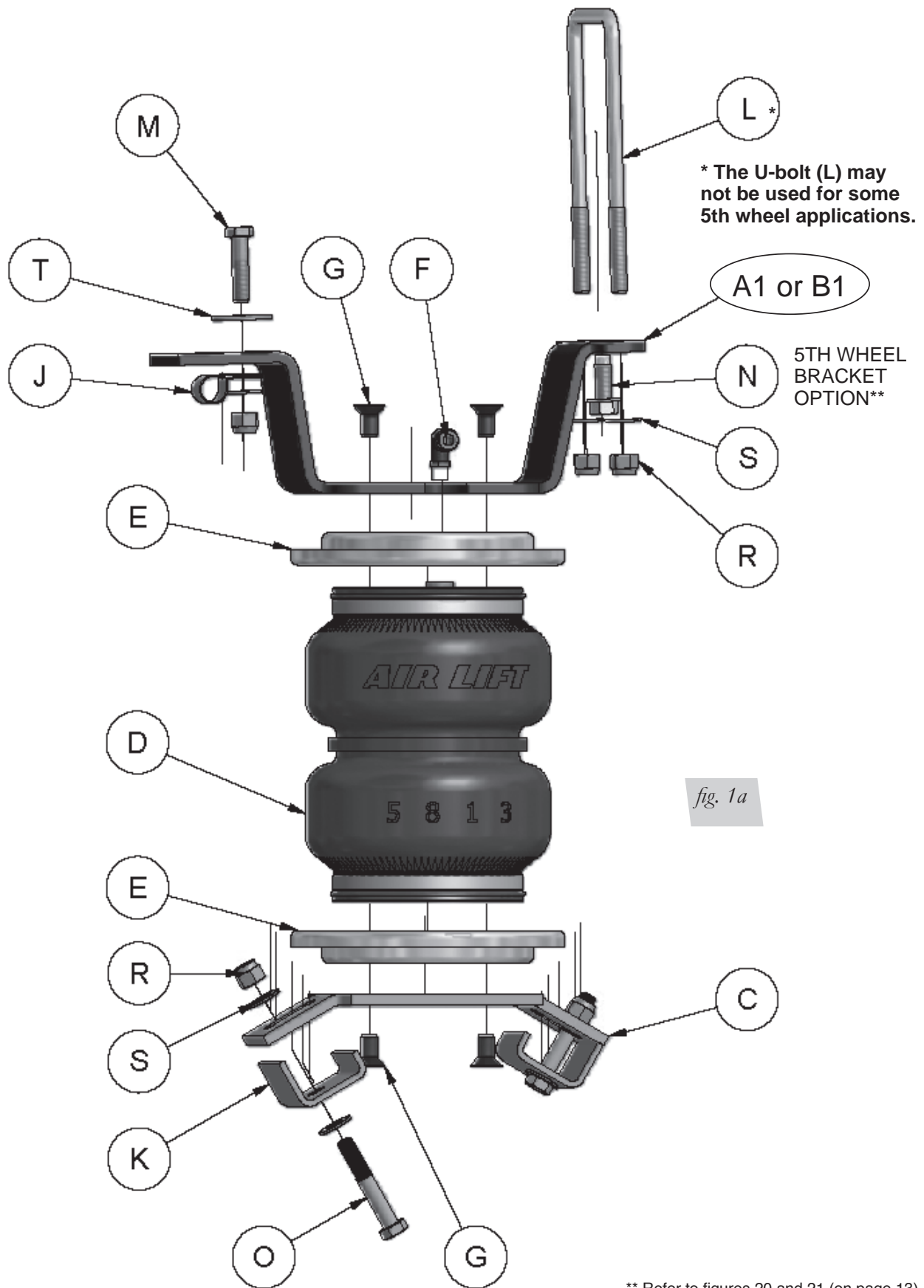
---

## NOTE

*Indicates a procedure, practice or hint which is important to highlight.*

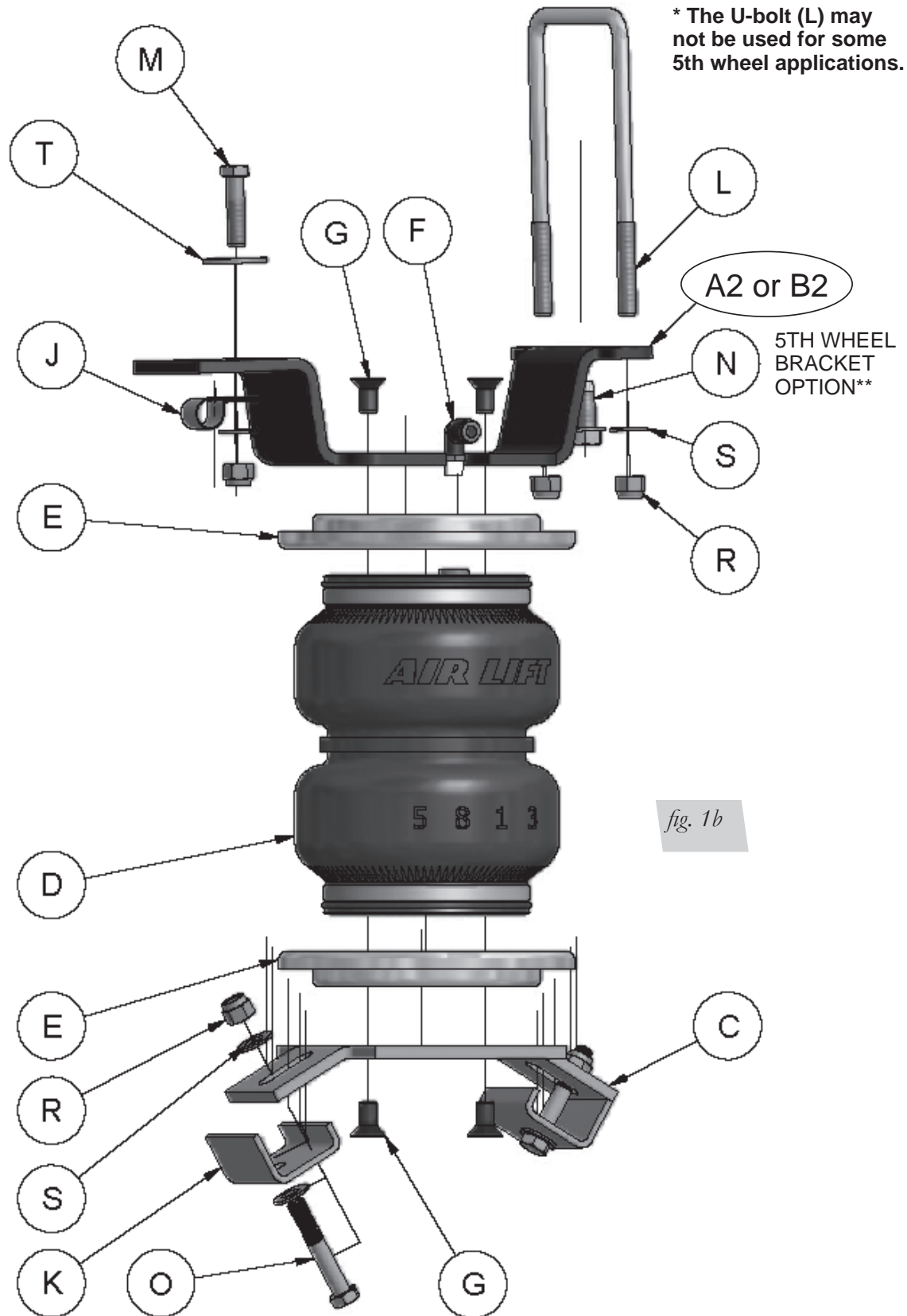
---

# Installation Diagram for Kit 57204



\*\* Refer to figures 20 and 21 (on page 13)

# Installation Diagram for Kit 57211



\*\* Refer to figures 20 and 21 (on page 13)

# Hardware and Tools Lists

## HARDWARE LIST

Item	Part #	Description .....	Qty	Item	Part #	Description .....	Qty
A1	07154	RH Upper Brakcet (kit# 57204).....	1	O	17420	3/8"-16 X 2.25" Hex Head Bolt.....	4
A2	07040	RH Upper Bracket (kit# 57211).....	1	R	18435	3/8" Nylon Locknut .....	10
B1	07155	LH Upper Bracket (kit# 57204).....	1	S	18444	3/8" Flat Washer (Small OD).....	14
B2	07039	LH Upper Bracket (kit# 57211).....	1	T	18447	3/8" Flat Washer (Large OD).....	2
C	03021	Lower Bracket .....	2	U	09484	Hose Thermal Sleeve.....	1
D	58437	Air Spring .....	2	V	17107	3/8"-16 X 1" Hex Head Bolt.....	1
E	11951	Roll Plate.....	4	AA	20086	Air Line .....	1
F	21837	90° Swivel Elbow Fitting.....	2	BB	10466	Tie Strap.....	6
G	17215	3/8"-24 X 3/4" Flat Head Screws.....	8	CC	21230	Valve Cap.....	2
H	11968	3/8" Wire Bolt Leader Tool .....	1	DD	18405	5/16" Flat Washer.....	2
I	10181	Frame Clamp (Large).....	1	EE	21234	Rubber Washer .....	2
J	10778	Frame Clamp (Small).....	2	FF	18411	Star Washer .....	2
K	01663	J-Clamp.....	4	GG	21233	5/16" Hex Nut.....	4
L	11046	U-Bolt .....	2				
M	17108	3/8"-16 X 1.5" Hex Head Bolt.....	2				
N	17129	3/8" X 1" Washer Head S/T Screw.....	2				

## TOOLS LIST

Description.....	Qty
Hoist or floor jacks.....	1
Safety stands.....	2
Safety glasses .....	1
Torque wrench.....	1
Standard open-end combo wrenches.....	1
Ratchet .....	1
Metric and standard sockets.....	1
7/32 Allen wrench (socket if available) .....	1
5/16" drill bit (very sharp).....	1
Heavy duty drill.....	1
Hose cutter, razor blade or sharp knife .....	1
Air compressor or compressed air source.....	1
Spray bottle with dish soap/water solution .....	1

# Installing the LoadLifter 5000 System

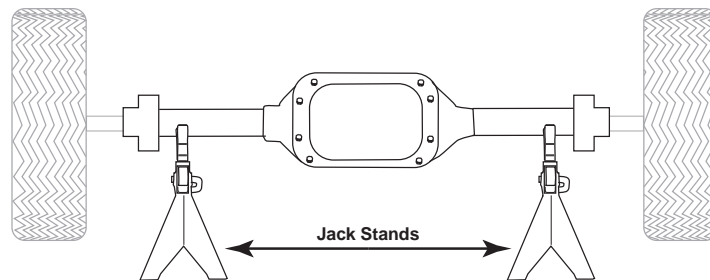
## GETTING STARTED



**DANGER**

COMPRESSED AIR CAN CAUSE INJURY AND DAMAGE TO THE VEHICLE AND PARTS IF IT IS NOT HANDLED PROPERLY. FOR YOUR SAFETY, DO NOT TRY TO INFLATE THE AIR SPRINGS UNTIL THEY HAVE BEEN PROPERLY SECURED TO THE VEHICLE.

1. Raise the vehicle and support the axle with jack stands, setting the jack stands as wide as possible on the axle (Fig. 2).



*fig. 2*

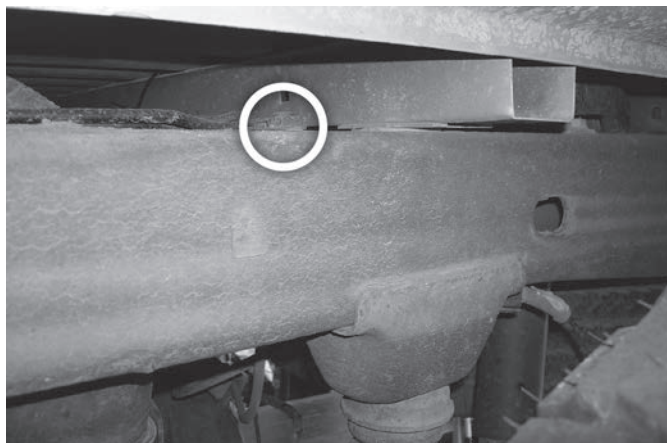
2. Drop the axle or raise the frame up to make room for the assemblies to be put into position between the frame and axle.
3. Remove and discard the line holder located on the left side (driver side) of the frame rail to the inside of the frame, just forward of the axle (Fig. 3).



*Inside frame,  
left hand  
(driver side)  
view*

*fig. 3*

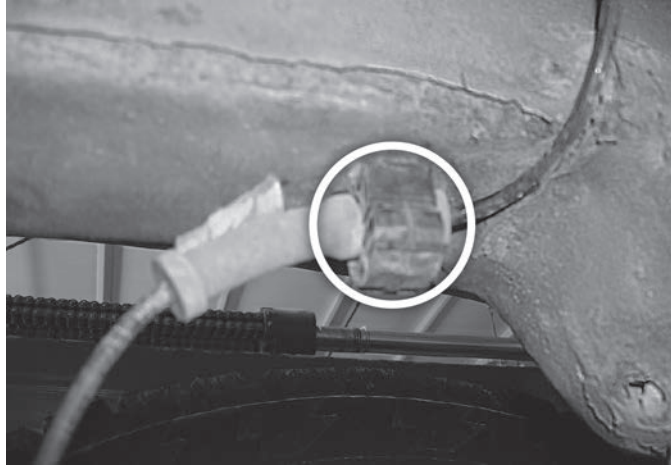
4. Pull up on and remove the pin holding the line holder in place on top of the frame (Fig. 4). Unhook the lines and remove the line holder. Discard the line holder since it will no longer be used.



*Outside frame,  
left hand  
(driver side)  
view*

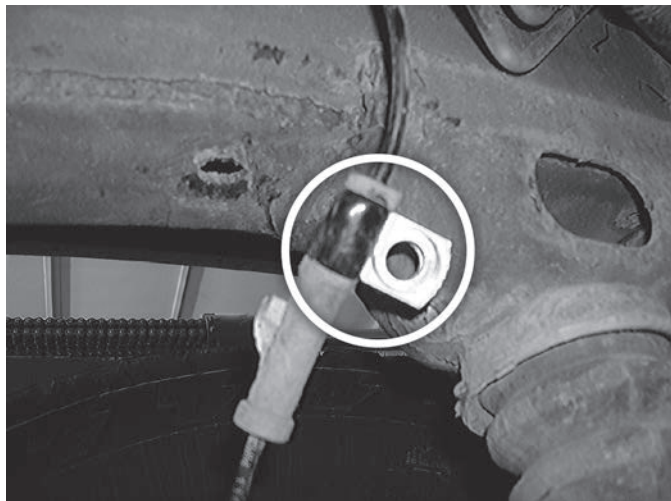
*fig. 4*

5. Pull the ABS line holders attached to the bottom of the frame, behind the axle, on the left (driver) and right (passenger) hand side, out from the frame and remove from the ABS line (Fig. 5).



*fig. 5*

6. Use a small screw driver to unhook the clamp from the line and remove. Discard the clamp since it will no longer be used.
7. Install the small frame clamps (J) onto the ABS line where the stock line holders were attached with the hole facing forward on the line (Fig. 6). Do this for both sides.



*Left (driver) side view*

*fig. 6*

8. Leave the ABS line hanging loose for later installation.

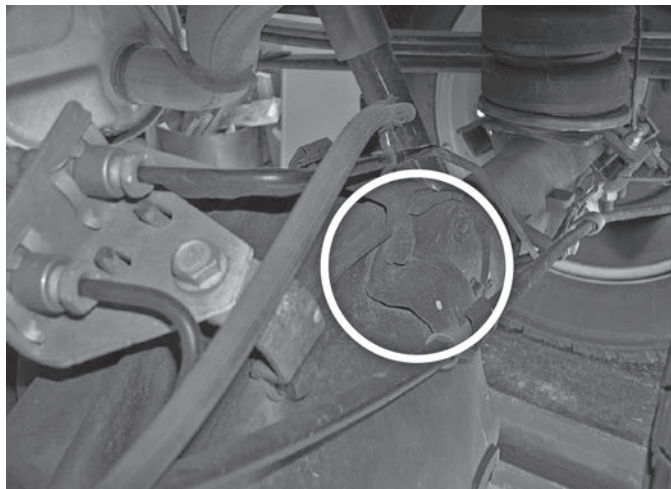
**CAUTION**

BECAUSE THE EMERGENCY BRAKE CABLE IS IN A LOCATION THAT MAKES IT POSSIBLE TO RUB A HOLE IN THE SIDE OF THE AIR SPRING FLEX MEMBER, IT WILL BE NECESSARY TO RE-LOCATE IT AWAY FROM THE AREA WHERE THE AIR SPRING IS INSTALLED.

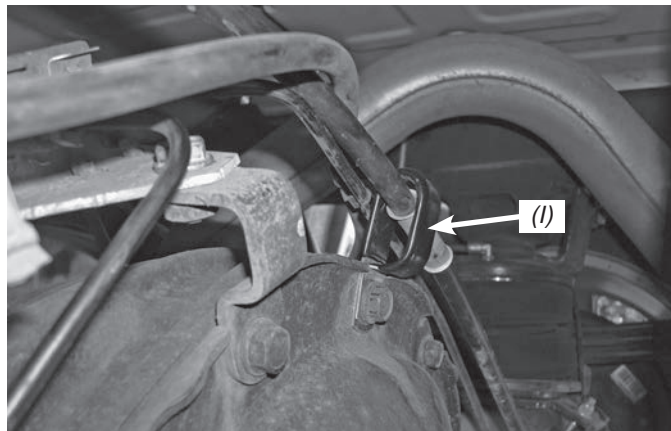
**Emergency Brake Cable modifications for kit #57204 are as follows:**

9. It will be necessary to re-locate the Emergency Brake Cable that is held by a bracket on the top of the axle center carrier section of the rear end (Fig. 7).
10. Remove the top bolt that is holding the Emergency Brake Cable bracket onto the center section of the rear end (Fig. 7).
11. Remove the bracket from the Emergency Brake Cable and discard (Fig. 7).

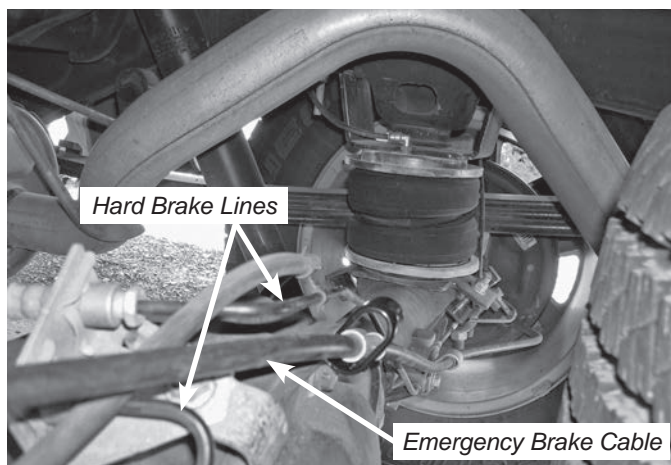



*fig. 7*

12. Install the large frame clamp (I) over the Emergency Brake Cable facing the rear with the hole down (Fig. 8) and attach to the rear end using the stock bolt previously removed.


*fig. 8*

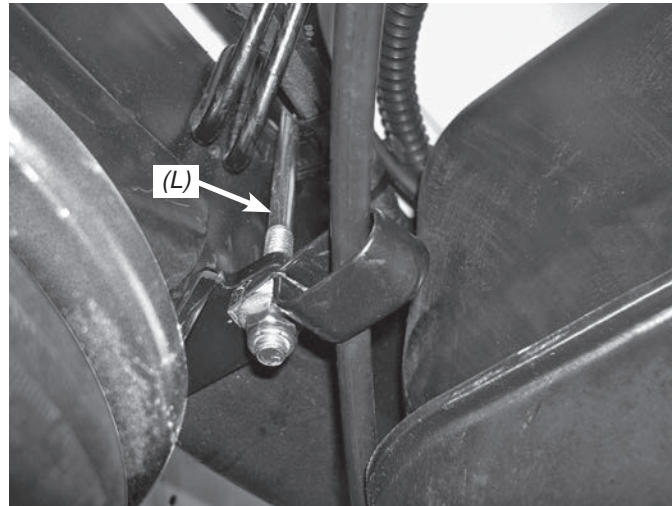
13. Bend the frame clamp slightly to obtain clearance on the hard brake lines mounting to the top of the axle (Fig. 9).


*fig. 9*

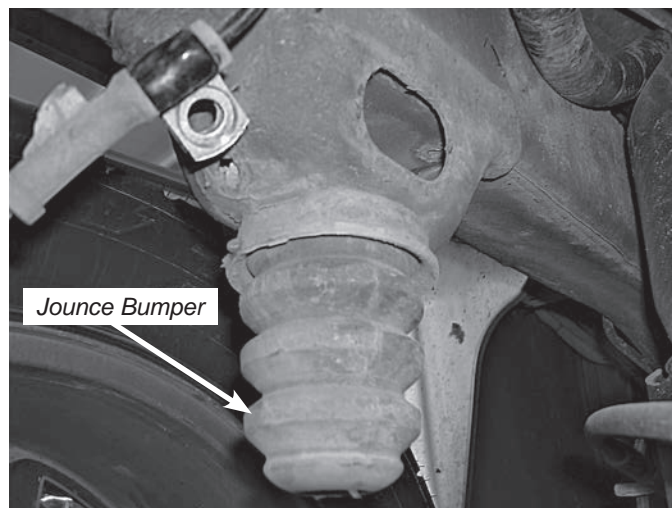
**Emergency Brake Cable modifications for kit #57211 are as follows:****NOTE**

*This step will be done in conjunction with step 5 of the "Installing the Air Spring Assemblies" section.*

14. Insert the Emergency Brake Cable into the large frame clamp (I) (Fig. 10).
15. Install the large frame clamp onto the U-bolt (L), inside the frame on the left side (driver side) with the clamp pointing inboard towards the center of the vehicle (Fig. 10).
16. Torque the U-Bolt as specified in step 5 if using the U-Bolt to mount the upper bracket (Fig. 10). If you have a 5th wheel bracket and use the center hole, instead of the U-bolt, to mount the upper bracket, attach the large frame clamp (I) using the 3/8" bolt (V), 3/8" Flat washer (S) and Nylon Lock Nut (R) supplied. Tighten to 10 lb.-ft.

*fig. 10*

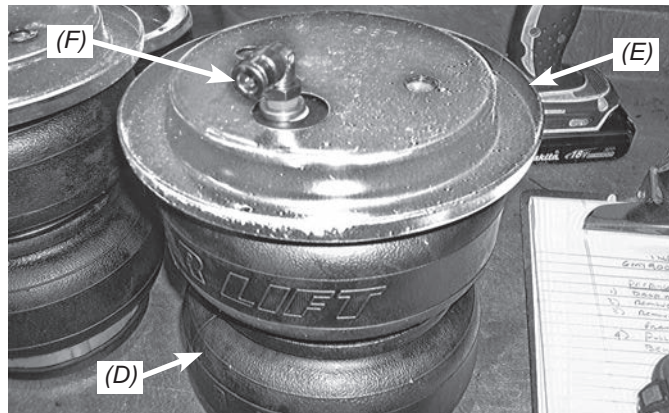
17. Remove the stock jounce bumpers from under the frame rails. These are above the axle on both the right and left sides (Fig. 11).

*fig. 11*

18. Remove the jounce bumpers by unbolting them from the jounce bumper mounting cups welded to the frame.
19. Pull or pry the jounce bumpers out of the cup with a screw driver once the bolt has been removed.

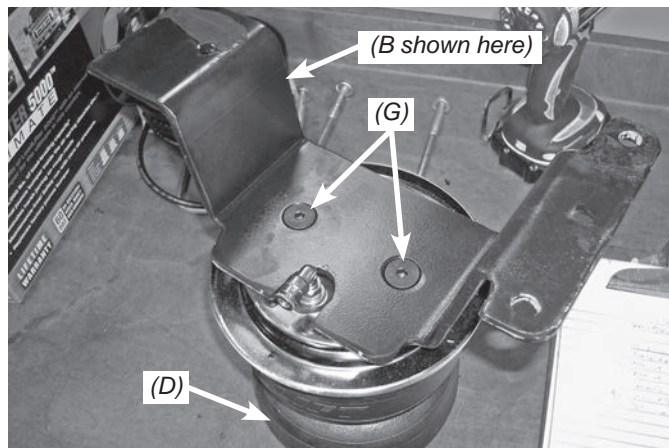
## ASSEMBLING THE AIR SPRING ASSEMBLIES

1. Set a roll plate (E) over the top of the air spring (D) (Fig. 12).


*fig. 12*
**NOTE**

*The radiused (rounded) edge of the roll plate (E) will be towards the bellows so that the bellows is seated inside both roll plates.*

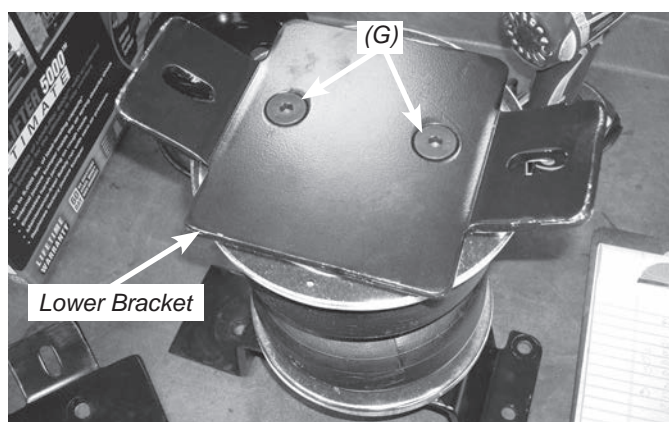
2. Install the swivel fitting (F) into the top of the air spring finger tight plus one and a half turns. Do not over tighten.
3. Install the upper bracket (A & B) onto the air spring (D) using four flat head screws (G) (Fig. 13). Torque to no more than 20 lb.-ft.


*fig. 13*

4. Install the lower bracket (E) onto the bottom of the air spring using the Flat Head Screws (G) (Fig. 14). Torque to no more than 20 lb.-ft.

**NOTE**

*The arrow on the lower bracket points to the opposite side of the fitting on the air spring assembly (outboard towards the tire).*


*fig. 14*

- Figure 15 shows both left and right hand assembly's ready to install.

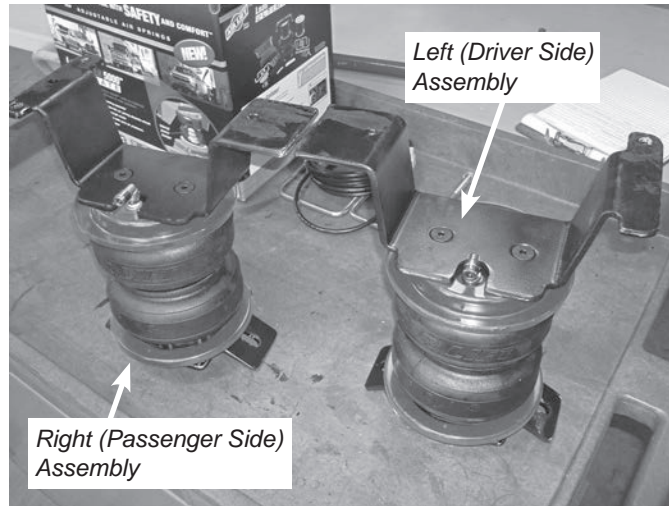


fig. 15

### INSTALLING THE AIR SPRING ASSEMBLIES

- Install a large flat washer (T) over the hex head bolt (M) and thread the wire bolt leader tool (H) onto the threads of the bolt (Fig. 16).

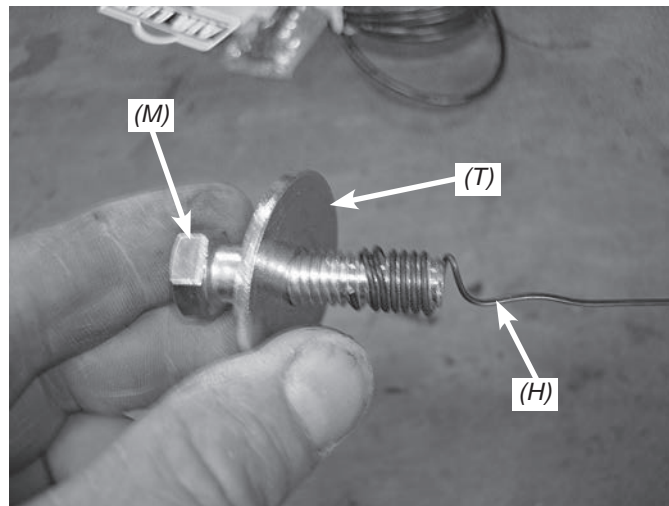


fig. 16

- Insert the bolt and washer in through the slot in the side of the frame, and through the slot in the bottom of the frame the ABS line holder was removed (Fig. 17). Repeat for the other side.



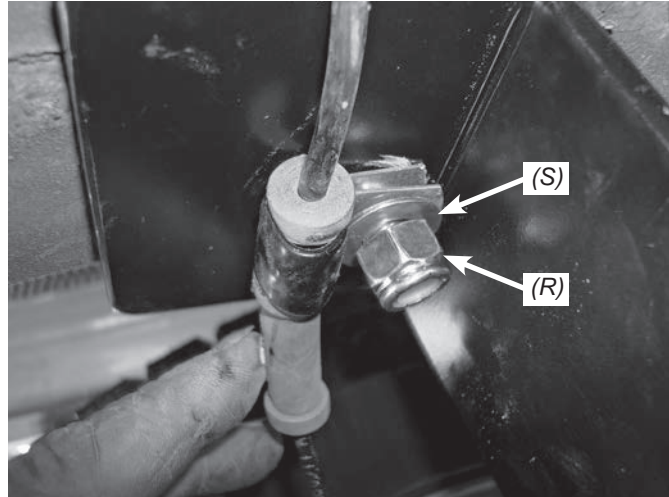
fig. 17

3. Set the left hand assembly (with the L on the bracket) on the left (driver) side of the axle. Repeat for the right (passenger) side.

**NOTE**

*The fitting on both air springs will be inboard.*

4. While raising the assembly, line up the bolt previously installed with the back hole on the bracket. Set the new ABS line holder over the bolt once the upper bracket is in place and cap with a flat washer (S) and nylon locknut (R) (Fig. 18). Leave loose at this time.



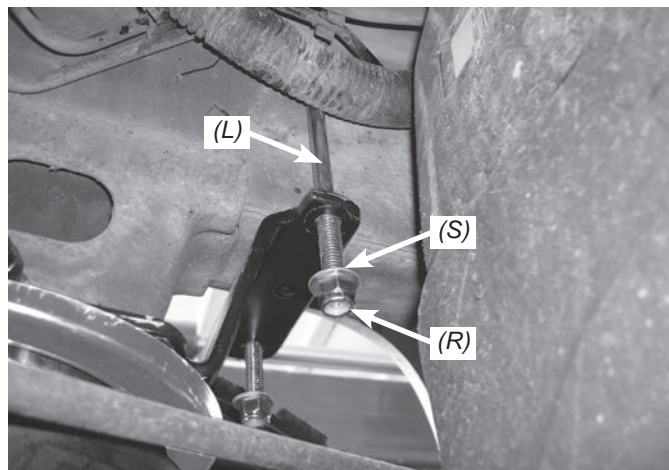
*fig. 18*

There are two ways to attach the front side of the upper bracket depending on whether you have a 5<sup>th</sup> wheel bracket running alongside of the frame or not.

5. For vehicles with NO 5<sup>th</sup> wheel bracket along the side of the frame: Set the U-Bolt (L) over the frame and through the holes in the upper bracket forward of the axle (Fig. 19).

 **CAUTION**

DO NOT PINCH THE LINES ON THE LEFT (DRIVER) SIDE FRAME RAIL.



*fig. 19*

6. Cap with flat washers (S) and nylon locknut (R). Position the front upper bracket onto the frame rail so the center hole is in the middle of the frame and there is sufficient clearance between the fitting and the stock jounce bumper cup.
7. Torque the U-Bolts to 10 lb.-ft. Repeat for the other side.
8. For vehicles with a 5<sup>th</sup> wheel hitch bracket that runs alongside of the frame: Center the upper bracket in the middle of the frame rail, make sure there is sufficient clearance between the fitting and the stock jounce bumper cup, and drill a 5/16" hole in the frame using the center hole in the front side of the upper bracket as a template (Fig. 20). Install the washer head self tapping screw (N) in the hole (Fig. 21). Torque to 15 lb.-ft. Repeat for the other side.

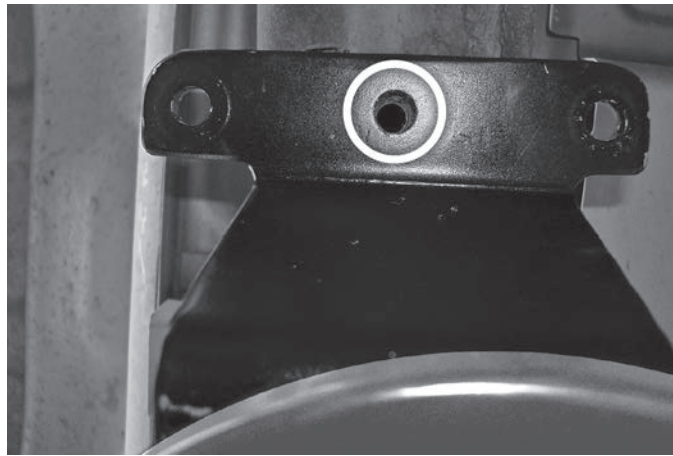


fig. 20

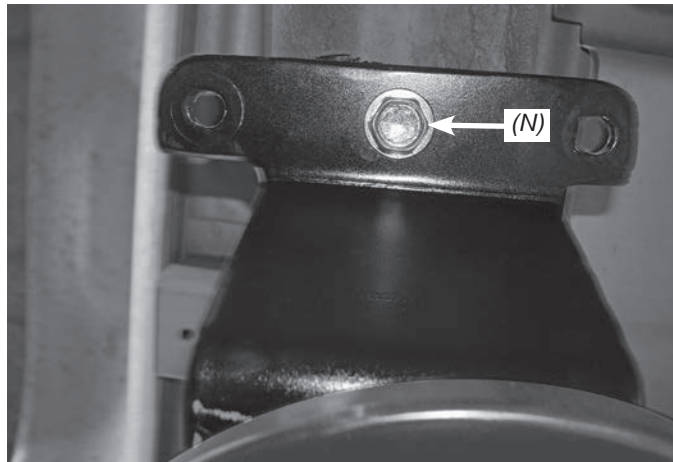


fig. 21

9. Finish the upper bracket installation by torquing the rear bolt to 15 lb.-ft..

**NOTE**

Use a 1/4" drive ratchet and long 9/16" socket through the hole in the side of the frame to hold the rear mounting bolt for torquing (Fig. 22).

*Long Box models (Kit #57211) may require a short extension.*

**TECH TIP:** Use the wire leader bolt tool (H) to help retrieve the extension and socket from inside the frame. Insert the short extension through the coil end of the tool (Fig. 23).

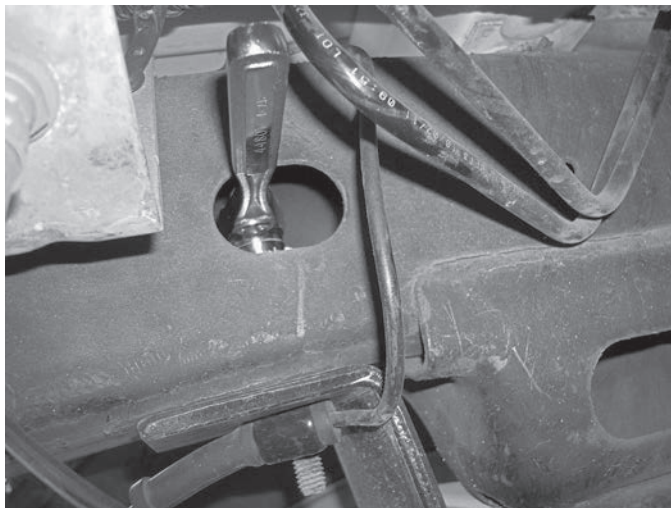


fig. 22



fig. 23

## LOWER BRACKET INSTALLATION

1. Push the lower bracket (C) forward or back to center it over the jounce bumper strike plate. Insert a Hex Head Bolt (O) through a flat washer (S) and J-clamp (K) (Fig. 24). Install the J-clamp with the short end under the jounce bumper strike plate with the bolt through the lower bracket. Cap with a flat washer (S) and nylon locknut (R). Do this on the front and rear of the lower bracket and evenly torque both sides to 10 lb.-ft. keeping the lower bracket centered over the jounce bumper strike plate on the axle. Repeat for the other side.

### NOTE

*It may be necessary on some models to slightly pull down the hard brake line on the rear right (passenger side) in order to install the lower bracket mounting hardware.*

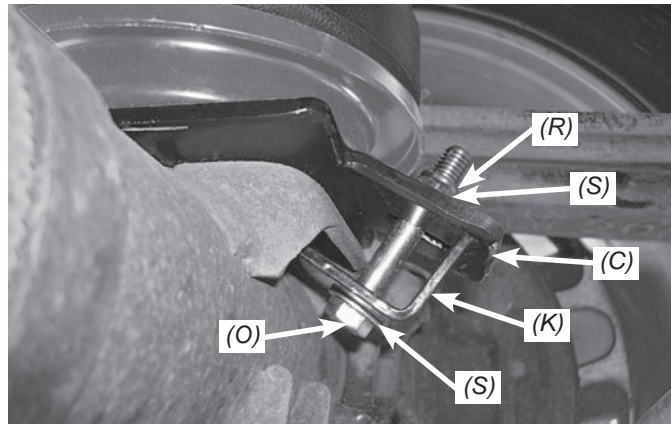


fig. 24

## INSTALLING THE AIR LINES

1. Choose a convenient location for mounting the inflation valves. Popular locations for the inflation valve are:
  - a. The wheel well flanges
  - b. The license plate recess in bumper
  - c. Under the gas cap access door
  - d. Through the license plate

### NOTE

*Whatever the chosen location, make sure there is enough clearance around the inflation valves for an air chuck.*

2. Drill two 5/16" holes to install the inflation valves.
3. Cut the air line assembly in two equal lengths.

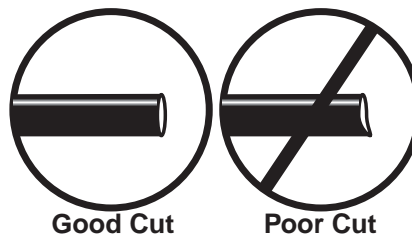
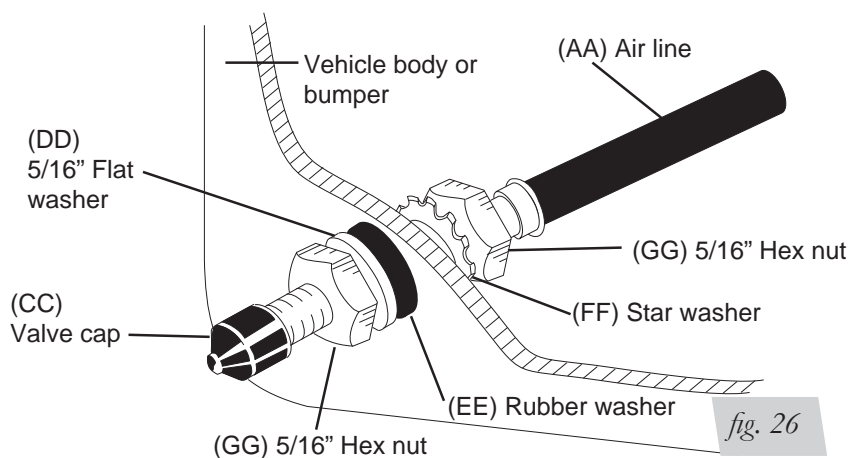


fig. 25

### CAUTION

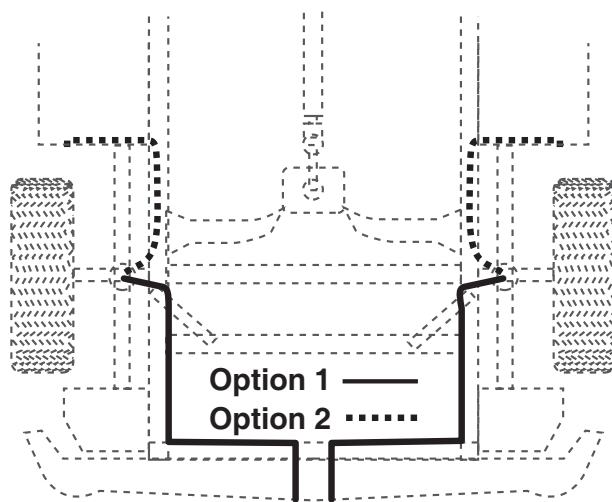
WHEN CUTTING OR TRIMMING THE AIR LINE, USE A HOSE CUTTER, A RAZOR BLADE, OR A SHARP KNIFE. A CLEAN, SQUARE CUT WILL ENSURE AGAINST LEAKS. DO NOT USE WIRE CUTTERS OR SCISSORS TO CUT THE AIR LINE. THESE TOOLS MAY FLATTEN OR CRIMP THE AIR LINE CAUSING IT TO LEAK AROUND THE O-RING SEAL INSIDE THE ELBOW FITTING (FIG. 25).



4. Place a 5/16" nut and star washer on the air valve. Leave enough of the inflation valve in front of the nut to extend through the hole and have room for the rubber washer, flat washer, and 5/16" nut and cap. There should be enough valve exposed after installation—approximately 1/2"—to easily apply a pressure gauge or an air chuck (Fig. 26).
5. Push the inflation valve through the hole and use the rubber washer, flat washer, and another 5/16" nut to secure it in place. Tighten the nuts to secure the assembly.
6. Route the air line along the frame to the air fitting on the air spring (Fig. 27). Keep AT LEAST 6" of clearance between the air line and heat sources, such as the exhaust pipes, muffler, or catalytic converter. Avoid sharp bends and edges. Use the plastic tie straps to secure the air line to fixed, non-moving points along the chassis. Be sure that the tie straps are tight, but do not pinch the air line. Leave at least 2" of slack to allow for any movement that might pull on the air line.

**NOTE**

*Tie off the hose to the front hole of the upper bracket or U-Bolt, depending on the mounting, with a tie strap to keep the hose away from the exhaust (Fig. 30).*



7. Cut off the air line, leaving approximately 12" of extra air line. A clean square cut will ensure against leaks. Insert the air line into the air fitting. This is a push-to-connect fitting. Simply push the air line into the 90° swivel fitting until it bottoms out (9/16" of air line should be in the fitting).



## INSTALLING THE HOSE HEAT SHIELD

1. Some late models will have an exhaust resonator behind the axle. Try to route the hose away from this heat source (to the outside of the frame then back) if possible. If not, be sure to install the hose heat shield (U) over the right (driver side) hose before attaching to the fitting (Fig. 28).



fig. 28

### NOTE

*Tie off hose to the front hole of the upper bracket or U-Bolt, depending on the mounting, with a tie strap to keep the hose away from the exhaust (Fig. 30).*

2. Raise or lower the axle, remove jack stands.

## CHECKING FOR LEAKS

1. Inflate the air spring to 30 PSI.
2. Spray all connections and the inflation valves with a solution of 1/5 liquid dish soap and 4/5 water. Spot leaks easily by looking for bubbles in the soapy water.
3. After the test, deflate the springs to the minimum pressure required to restore the system to normal ride height. Do not deflate to lower than 5 PSI.
4. Check the air pressure again after 24 hours. A 2 - 4 PSI loss after initial installation is normal. Retest for leaks if the loss is more than 5 lbs.

## FIXING LEAKS

1. If there is a problem with the swivel fitting:
  - a. Check the air line connection by deflating the spring and removing the line by pulling the collar against the fitting and pulling firmly on the air line. Trim 1" off the end of the air line. Be sure the cut is clean and square (see Fig. 25). Reinsert the air line into the push-to-connect fitting.
  - b. Check the threaded connection by tightening the swivel fitting another 1/2 turn. If it still leaks, deflate the air spring, remove the fitting, and re-coat the threads with thread sealant. Reinstall by hand tightening as much as possible and then use a wrench for an additional two turns.
2. If there is a problem with the inflation valve:
  - a. Check the valve core by tightening it with a valve core tool.
  - b. Check the air line by removing the air line from the barbed type fitting. Cut the air line off a few inches in front of the fitting and use a pair of pliers or vice grips to pull/twist the air line off of the fitting.

**CAUTION**

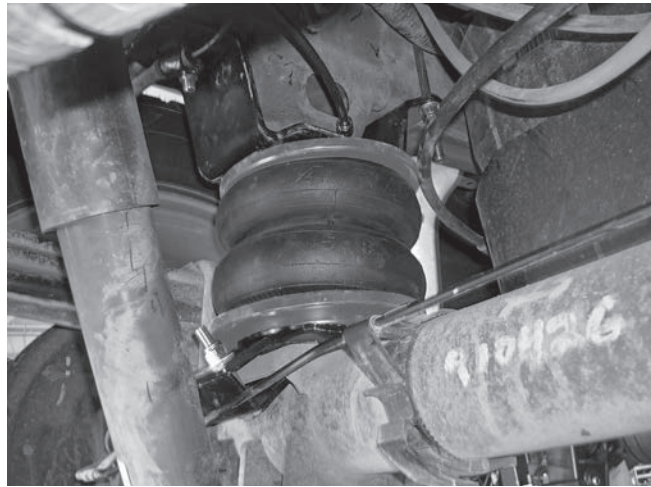
DO NOT CUT OFF THE AIR LINE COMPLETELY AS THIS WILL USUALLY NICK THE BARB AND RENDER THE FITTING USELESS.

**LEFT AND RIGHT HAND INSTALLATION PHOTOS**

1. Left (driver) side installation shown (Fig. 29).

**NOTE**

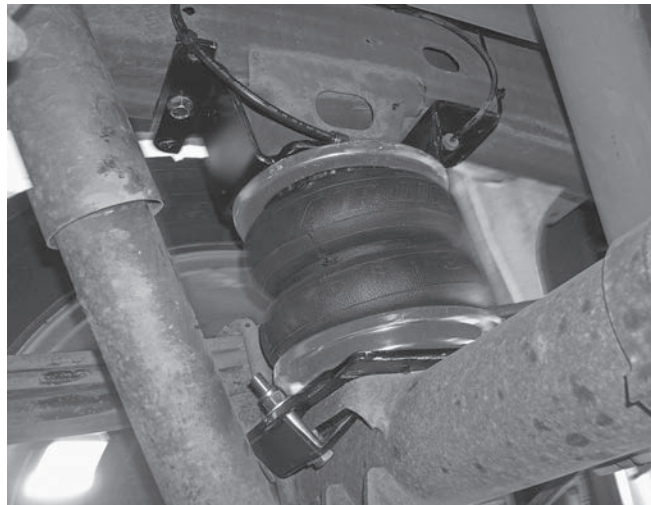
*This upper bracket is shown mounted with the U-Bolts and would be the non-5th wheel hitch mounting option.*

*fig. 29*

2. Tie off the hose to the front hole or U-Bolt, depending on the mounting, with a tie strap to keep the hose away from the exhaust.
3. Right (passenger) side installation shown (Fig. 30).

**NOTE**

*This upper bracket is shown mounted with the 5th wheel hitch mounting option (no U-Bolt mounting).*

*fig. 30*

# Before Operating

## INSTALLATION CHECKLIST (To be completed by installer)

- Clearance test — Inflate the air springs to 60 PSI and ensure there is at least 1/2" clearance around each bellow, away from anything that might rub against them. Be sure to check the tire, brake drum, frame, shock absorbers and brake cables.
- Leak test before road test — Inflate the air springs to 60 PSI, check all connections for leaks with a soapy water solution. See the *Checking for Leaks* section for tips on how to spot leaks. All leaks must be eliminated before the vehicle is road tested.
- Heat test — Be sure there is sufficient clearance from any heat sources — at least 6" for air springs and air lines.
- Fastener test — Recheck all bolts for proper torque. Re-torque after 100 miles.
- Road test — The vehicle should be road tested after the preceding tests. Inflate the air springs to 25 PSI (50 PSI if the vehicle is loaded). Drive the vehicle 10 miles and recheck for clearance, loose fasteners and air leaks.
- Operating instructions — If professionally installed, the installer should review the *Product Use, Maintenance and Servicing* section with the owner. Be sure to provide the owner with all of the paperwork which came with the kit.

**Technician's Signature** \_\_\_\_\_

**Date** \_\_\_\_\_

## POST-INSTALLATION CHECKLIST

- Overnight leak down test — Recheck air pressure after the vehicle has been used for 24 hours. If the pressure has dropped more than 5 PSI, then there is a leak that must be fixed. Either fix the leak yourself or return to the installer for service.
- Air pressure requirements — Regardless of load, the air pressure should always be adjusted to maintain ride height at all times.
- Thirty day or 500 mile test — Recheck the air spring system after 30 days or 500 miles, whichever comes first. If any part shows signs of rubbing or abrasion, the source should be identified and moved, if possible. If it is not possible to relocate the cause of the abrasion, the air spring may need to be remounted. If professionally installed, the installer should be consulted. Check all fasteners for tightness.

# Product Use, Maintenance and Servicing

Minimum Recommended Pressure	Maximum Air Pressure
5 PSI	100 PSI

## MAINTENANCE GUIDELINES

### NOTE

*By following the steps below, vehicle owners will obtain the longest life and best results from their air springs.*

1. Check the air pressure weekly.
2. Always maintain normal ride height. Never inflate beyond 100 PSI.
3. If you develop an air leak in the system, use a soapy water solution (1/5 liquid dish soap and 4/5 water) to check all air line connections and the inflation valve core before deflating and removing the air spring.



### CAUTION

FOR YOUR SAFETY AND TO PREVENT POSSIBLE DAMAGE TO YOUR VEHICLE, DO NOT EXCEED MAXIMUM GROSS VEHICLE WEIGHT RATING (GVWR), AS INDICATED BY THE VEHICLE MANUFACTURER. ALTHOUGH YOUR AIR SPRINGS ARE RATED AT A MAXIMUM INFLATION PRESSURE OF 100 PSI, THE AIR PRESSURE ACTUALLY NEEDED IS DEPENDANT ON YOUR LOAD AND GVWR.

4. Loaded vehicles require at least 25 PSI or more. A "loaded vehicle" refers to a vehicle with a heavy bed load, a trailer, or both. As discussed above, never exceed GVWR, regardless of air spring, air pressure, or other load assist. The springs in this kit will support approximately 40 lbs. of load (combined on both springs) for each 1 PSI of pressure. The required air pressure will vary depending on the state of the original suspension. Operating the vehicle below the minimum air spring pressure will void the Air Lift warranty.
5. When increasing load, always adjust the air pressure to maintain the normal ride height. Increase or decrease pressure from the system as necessary to attain normal ride height for optimal ride and handling. Remember that loads carried behind the axle (including tongue loads) require more leveling force (pressure) than those carried directly over the axle.
6. Always add air to springs in small quantities, checking the pressure frequently.
7. Should it become necessary to raise the vehicle by the frame, make sure the system is at minimum pressure (5 PSI) to reduce the tension on the suspension/brake components. Use of on board leveling systems do not require deflation or disconnection.
8. Periodically check the air spring system fasteners for tightness. Also, check the air springs for any signs of rubbing. Realign if necessary.
9. On occasion, give the air springs a hard spray with a garden hose in order to remove mud, sand, gravel or other abrasive debris.

## TROUBLESHOOTING GUIDE

1. Leak test the air line connections, the threaded connection into the air spring, and all fittings in the control system.
2. Inspect the air lines to be sure none are pinched. Tie straps may be too tight. Loosen or replace the strap and replace leaking components.
3. Inspect the air line for holes and cracks. Replace as needed.
4. Look for a kink or fold in the air line. Reroute as needed.

## FREQUENTLY ASKED QUESTIONS

### Q. Will installing air springs increase the weight ratings of a vehicle?

No. Adding air springs will not change the weight ratings (GAWR, GCWR and/or GVWR) of a vehicle. Exceeding the GVWR is dangerous and voids the Air Lift warranty.

### Q. Is it necessary to keep air in the air springs at all times and how much pressure will they need?

The minimum air pressure should be maintained at all times. The minimum air pressure keeps the air spring in shape, ensuring that it will move throughout its travel without rubbing or wearing on itself.

### Q. Is it necessary to add a compressor system to the air springs?

No. Air pressure can be adjusted with any type of compressor as long as it can produce sufficient pressure to service the springs. Even a bicycle tire pump can be used, but it's a lot of work.

### Q. How long should air springs last?

If the air springs are properly installed and maintained they can last indefinitely.

### Q. Will raising the vehicle on a hoist for service work damage the air springs?

No. The vehicle can be lifted on a hoist for short-term service work such as tire rotation or oil changes. However, if the vehicle will be on the hoist for a prolonged period of time, support the axle with jack stands in order to take the tension off of the air springs.

## TUNING THE AIR PRESSURE

Pressure determination comes down to three things — level vehicle, ride comfort, and stability.

### 1. Level vehicle

If the vehicle's headlights are shining into the trees or the vehicle is leaning to one side, then it is not level (Fig. 2.1). Raise the air pressure to correct either of these problems and level the vehicle.

### 2. Ride comfort

If the vehicle has a rough or harsh ride it may be due to either too much pressure or not enough (Fig. 2.2). Try different pressures to determine the best ride comfort.

### 3. Stability

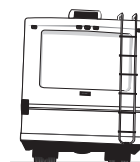
Stability translates into safety and should be the priority, meaning the driver may need to sacrifice a perfectly level and comfortable ride. Stability issues include roll control, bounce, dive during braking and sponginess (Fig. 2.3). Tuning out these problems usually requires an increase in pressure.



Bad headlight aim *fig. 2.1*



Rough ride *fig. 2.2*



Sway and body roll *fig. 2.3*

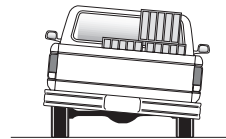
## GUIDELINES FOR ADDING AIR

1. Start with the vehicle level or slightly above.
2. When in doubt, always add air.
3. If the front of the vehicle dives while braking, increase the pressure in the front air bags, if equipped.
4. If it is ever suspected that the air bags have bottomed out, increase the pressure (Fig. 2.4).
5. Adjust the pressure up and down to find the best ride.
6. If the vehicle rocks and rolls, adjust the air pressure to reduce movement.
7. It may be necessary to maintain different pressures on each side of the vehicle. Loads such as water, fuel, and appliances will cause the vehicle to be heavier on one side (Fig. 2.5). As much as a 50 PSI difference is not uncommon.

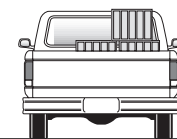


Bottoming out

*fig. 2.4*



Unlevel



Level

*fig. 2.5*

# Choosing the Right On-Board Air Compressor System

**60 DAY** NO QUESTIONS ASKED, MONEY-BACK GUARANTEE

**TWO-YEAR** COMPRESSOR SYSTEM WARRANTY

Add an on-board air compressor system to inflate and deflate your air springs automatically or with the touch of a button — from inside or outside of the vehicle.

- For convenient, on-the-go control of your air springs, add an Air Lift on-board air compressor system.
- Air Lift on-board air compressor systems eliminate the search for gas stations that have a working compressor, saving you time, energy and money.
- All systems include a compressor, controller and all parts needed for easy installation.

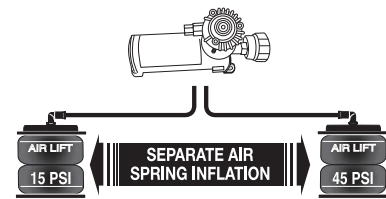
**1. Choose single or dual path inflation (see illustrations at right)**

**2. Choose wireless, analog control or automatic**

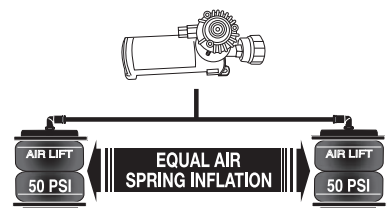
- **Wireless:** Control your air springs from inside or outside the vehicle. Easiest installation — no wires to the cab.
- **Analog:** In-cab control of your air springs. Economically priced.
- **Automatic:** Self-leveling system, keeps the vehicle level no matter what.

**3. Choose heavy or standard duty compressor**

- **Standard duty:** A standard duty compressor will work well for most customers who use their system on an intermittent basis.
- **Heavy duty:** For daily use, consider the heavy-duty compressor — it inflates faster and more quietly than the standard compressor.



**Dual path systems** Air springs are controlled separately to allow for different air pressure from side-to-side. Perfect for uneven or top-heavy loads.



**Single path systems** Two springs will inflate at the same time. Good for loads that are evenly distributed from left-to-right or front-to-back.

WIRELESS

ANALOG

AUTOMATIC

DUAL PATH

**WirelessAIR™**

OUR PREMIUM SYSTEM!

- Easy installation
- Includes heavy-duty compressor



P/N 72000

**LoadCONTROLLER™**

**Dual**

Compact, economically priced control.



P/N Standard Duty Compressor 25850; P/N Heavy Duty Compressor 25854

SINGLE PATH

**WirelessONE™**

- Easy installation
- Includes standard-duty compressor



P/N 25870

**LoadCONTROLLER™**

**Single**

Compact, economically priced control.



P/N Standard Duty Compressor 25852; P/N Heavy Duty Compressor 25856

**SmartAIR™ II**

- Easy installation
- Automatic self-leveling system
- No in-cab controls required



Single Path P/N 25490, Dual Path P/N 25491