

LoadLifter 5000™ SERIES



Installation Guide



Ford SD F-250/F-350 4WD SRW (Single Rear Wheel)

Kits 57352 | 88352 | 89352

For maximum effectiveness and safety, please read these instructions completely before proceeding with installation.

Failure to read these instructions can result in an incorrect installation.

TABLE OF CONTENTS

Installation Diagram	2
Hardware and Tools Lists	3
Introduction	4
Notation Explanation	4
Identifying the Differences Between Kits	4
Installing the System	5
Preparing the Vehicle	5
Assembling the Air Springs	6
Installing the Air Spring Assemblies	9
Installing the Air Lines	12
Installing Nylon Air Lines	12
Installing Braided Stainless Steel Air Lines	13
Installing the Heat Shield	14
Finished Installation	15
Installation Checklist	16
Maintenance and Use Guidelines	

Installation Diagram

Driver's
(left) Side

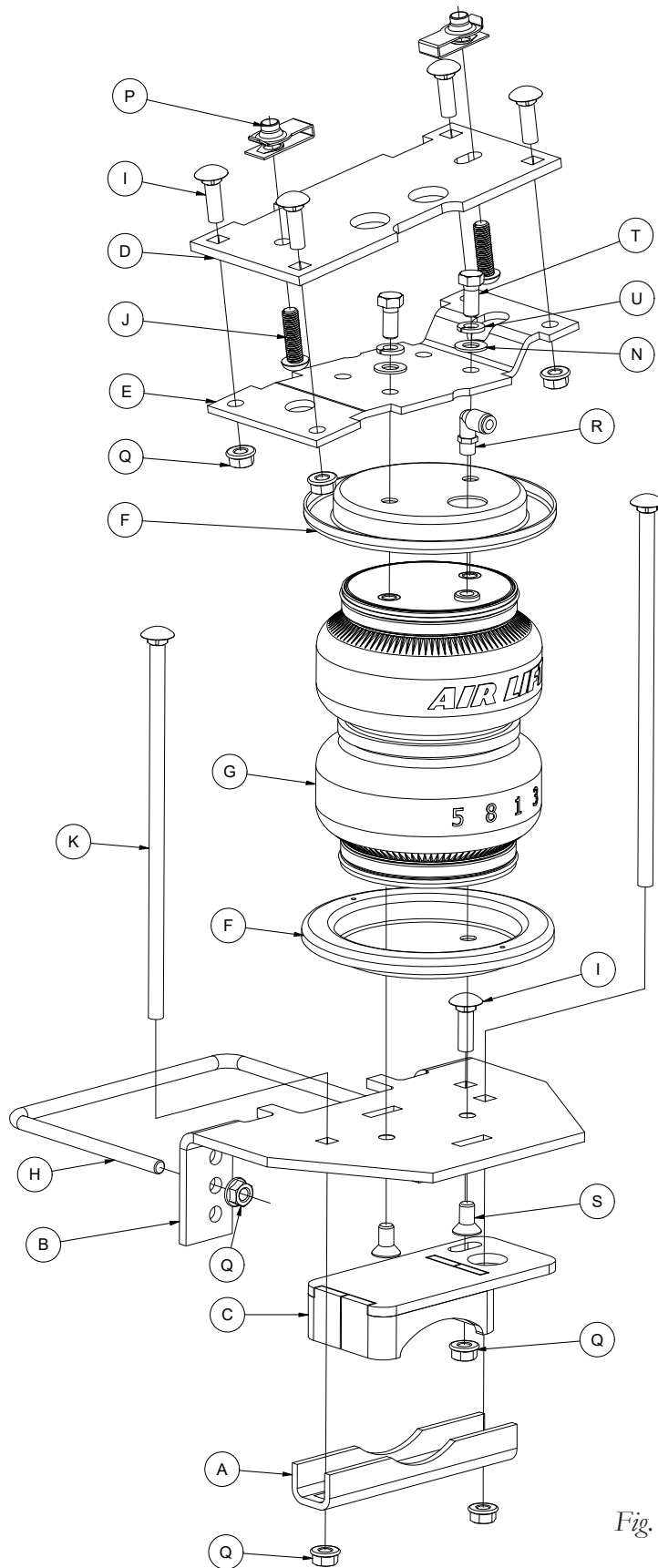

Fig. 1

Hardware and Tools Lists

Common Parts Included in All 3 Kits

Item	Part#	Description	Qty
A	01531	Clamp bar	2
B	03066	Lower bracket, main plate	2
C	03224	Lower bracket, cup	2
D	07045	Upper bracket, frame	2
E	07220	Upper bracket, air spring	2
H	11770	U-bolt	2
I	17134	3/8"-16 x 1" Carriage bolt	10
J	17366	M10-1.5 x 35 Button-head cap screw	4
K	17387	3/8"-16 x 10" Carriage bolt	4
O*	18501	M8 Stainless steel flat washer	2
P	18622	M10-1.5 Universal nut	4
Q	18422	3/8"-16 Serrated flange lock nut	18
DD*	21234	Rubber washer	2
EE*	18411	Stainless steel star washer	2

* These parts are not shown in the Installation Diagram (Fig. 1).

TOOLS LIST

Description	Qty
Standard and metric open-end or box wrenches	SET
Ratchet	1
Standard and metric sockets	SET
5/16" drill bit (very sharp)	1
9/16" Crow's foot adapter	1
9/16" ratchet combo wrench	1
Heavy-duty drill	1
Torque wrench	1
Standard and metric hex-key wrenches	1
Flat-tip screwdriver	1
Hose cutter, razor blade, or sharp knife	1
Hoist or floor jacks	1
Safety stands	2
Safety glasses	1
Air compressor or compressed air source	1
Spray bottle with dish soap/water solution	1

The photos in this manual show the LoadLifter 5000 kit.

Unique Parts in Each Kit

LoadLifter 5000™ KIT 57352

Item	Part#	Description	Qty
F	11951	Roll plate (silver zinc plated)	4
G	58437	Air spring	2
N	18444	3/8" Flat washer	4
R	21837	Push-to-connect (PTC) fitting	2
S	17215	3/8"-24 x 3/4" Flat-head socket-cap screw	4
T	17203	3/8"-24 x 7/8" Hex-cap screw	4
U	18427	3/8" Lock washer	4
AA*	20086	Air line assembly	1
BB*	10466	Zip tie	6
CC*	21230	Valve cap	2
FF*	21233	5/16" Hex nut	4

LoadLifter 5000™ ULTIMATE KIT 88352

Item	Part#	Description	Qty
F	11967	Roll plate (black powder coat)	4
G	58496	Air spring with jounce bumper	2
N	18444	3/8" Flat washer	4
R	21837	Push-to-connect (PTC) fitting	2
S	17215	3/8"-24 x 3/4" Flat-head socket-cap screw	4
T	17203	3/8"-24 x 7/8" Hex-cap screw	4
U	18427	3/8" Lock washer	4
AA*	20086	Air line assembly	1
BB*	10466	Zip tie	6
CC*	21230	Valve cap	2
FF*	21233	5/16" Hex nut	4

LoadLifter 5000™ ULTIMATE PLUS+ KIT 89352

Item	Part#	Description	Qty
F	11880	Roll plate (stainless steel)	4
G	58496	Air spring with jounce bumper	2
R	21815	AN-type fitting	2
N	18507	3/8" Stainless steel flat washer	4
S	17363	3/8"-24 x 3/4" Stainless flat-head socket-cap screw	4
T	17284	3/8"-24 x 7/8" Stainless steel hex-cap screw	4
U	18504	3/8" Stainless steel lock washer	4
AA*	20987	Stainless steel braided air line	2
BB*	10466	Zip tie	12
GG*	21907	Schrader valve w/ cap & nut	2
HH*	21813	AN to PTC fitting	2
II*	20084	Air line assembly	1

Introduction

The purpose of this publication is to assist with the installation and maintenance of the LoadLifter 5000 series air spring kits. All LoadLifter 5000 series kits utilize sturdy, reinforced, commercial-grade single or double, depending on the kit, convolute bellows.

The air springs are manufactured like a tire with layers of rubber and cords that control growth. LoadLifter 5000 kits provide up to 5,000 pounds (2,268kg) of load-leveling support with air adjustability from 5-100 PSI (.34-7BAR).

It is important to read and understand the entire installation guide before beginning installation or performing any maintenance, service or repair.

NOTATION EXPLANATION

Hazard notations appear in various locations in this publication. Information which is highlighted by one of these notations must be observed to help minimize risk of personal injury or possible improper installation which may render the vehicle unsafe. Notes are used to help emphasize areas of procedural importance and provide helpful suggestions. The following definitions explain the use of these notations as they appear throughout this guide.

DANGER

INDICATES IMMEDIATE HAZARDS WHICH WILL RESULT IN SEVERE PERSONAL INJURY OR DEATH.

WARNING

INDICATES HAZARDS OR UNSAFE PRACTICES WHICH COULD RESULT IN SEVERE PERSONAL INJURY OR DEATH.

CAUTION

INDICATES HAZARDS OR UNSAFE PRACTICES WHICH COULD RESULT IN DAMAGE TO THE MACHINE OR MINOR PERSONAL INJURY.

IDENTIFYING THE DIFFERENCES BETWEEN KITS

Should you need to contact Air Lift customer service, you will need to know which kit you are inquiring about: standard LoadLifter 5000, LoadLifter 5000 Ultimate or LoadLifter 5000 Ultimate Plus. The kits are easily identifiable by looking at the roll plates and air lines.

- Standard **LoadLifter 5000** — Zinc-plated steel roll plates and black nylon air lines.
- LoadLifter 5000 Ultimate** — Black powder-coated roll plates and black nylon air lines.
- LoadLifter 5000 Ultimate Plus** — Stainless steel roll plates, braided stainless steel air lines, stainless steel air spring mounting hardware.



LoadLifter 5000
silver zinc-plated steel
roll plate



LoadLifter 5000
nylon air line



LoadLifter 5000 Ultimate
black powder-coated roll plate



LoadLifter 5000 Ultimate
nylon air line



LoadLifter 5000 Ultimate Plus
stainless steel roll plate



LoadLifter 5000 Ultimate PLUS
braided stainless steel air line

Air Lift offers two Ultimate Plus upgrade kits:

52300 - Braided stainless steel air line and fittings.

52301 - Stainless steel roll plates, air spring mounting hardware, braided stainless steel air lines and fittings.

Installing the System

PREPARING THE VEHICLE

1. Raise the vehicle and support it, using safety stands or equivalent, so that the axle can be safely dropped away from the frame. This needs to be done in order for the air spring assembly to be put into position between the axle and frame (Fig. 2).

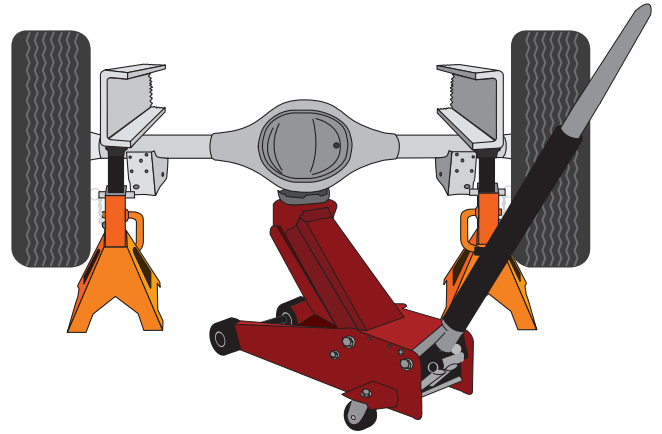

Fig. 2

2. Unbolt and remove the jounce bumper assembly from under the frame on both sides (Fig. 3).



Fig. 3

3. Remove the clip-in studs by prying on the hinged end with a screwdriver. Pull all four (two from each side) out from the frame (Fig. 4).

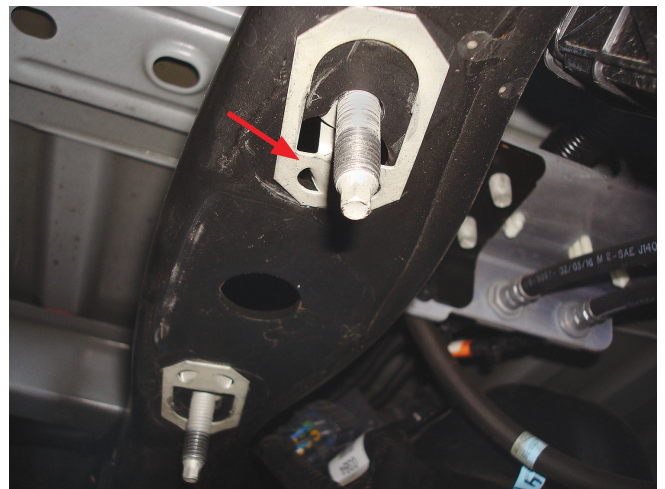

Fig. 4

4. Install the universal nuts (P) into the frame rail, lining up the holes in the frame and the threads in the nuts so that a bolt can be installed (Fig. 5).

TECH TIP

A flat-tip screwdriver works well in installing the universal nut into position.

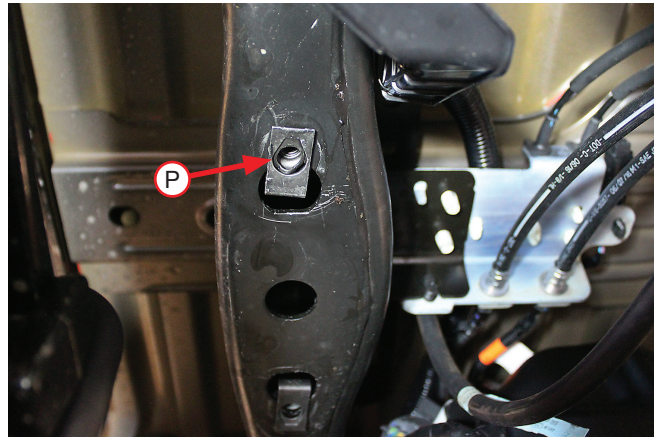

Fig. 5

5. Insert the 3/8"-16 x 1" carriage bolts (I) into the upper frame brackets (D). Install the upper bracket onto the frame using the M10-1.5 x 35mm button-head cap screws (J). The slot on the side of the bracket should be inboard of the frame rail (Fig. 6). The elongated hole should be toward the front of the truck (Fig. 7). Torque hardware to 38 lb.-ft. (52Nm).

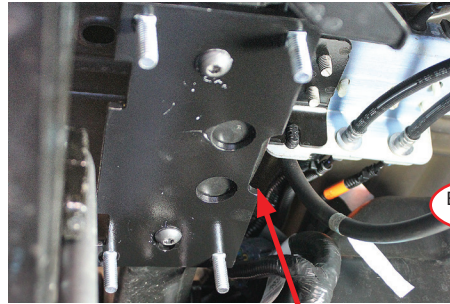

Fig. 6

This slot in the bracket goes inboard, away from leaf spring and tire

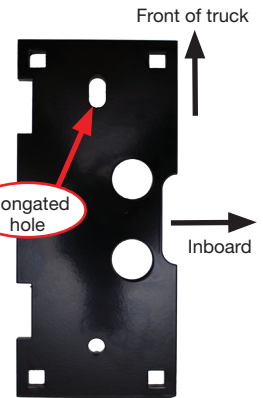

Fig. 7

ASSEMBLING THE AIR SPRINGS

1. Set a roll plate (F) on top of the air spring (G). The radiused, or rounded, edge of the roll plate should be toward the air spring so that it is seated inside the roll plate (Fig. 8). Install the 90 degree swivel fitting (R) into the port on top of the air spring, finger-tight plus 1 1/2 turns.

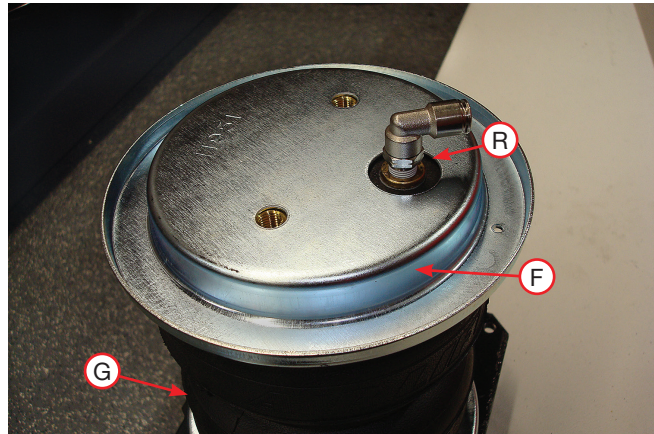

Fig. 8

- Set the upper air spring bracket (E) onto the top of the air spring using one set of holes with the 3/8"-24 x 7/8" hex-cap screw (T), 3/8" lock washer (U) and 3/8" flat washer (N) (Fig. 9). Install the remaining air spring bracket onto the remaining air spring, using the opposite holes from those that were previously used. This makes the air spring assemblies into left- and right-hand units. Torque the hardware to no more than 20 lb.-ft. (27Nm).

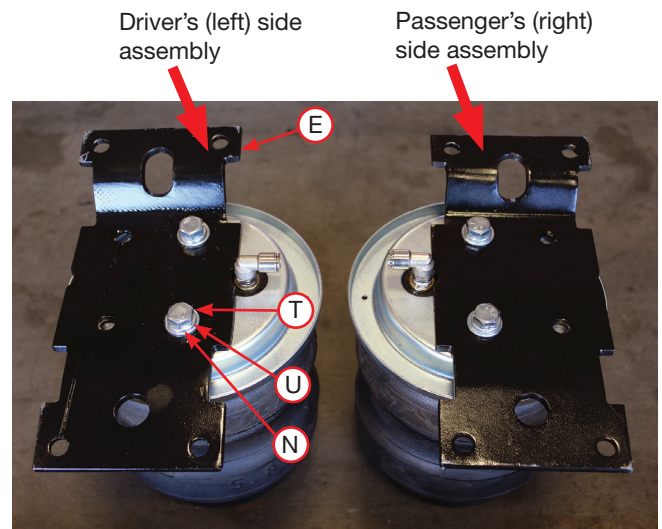

Fig. 9

- Flip the assemblies over and set a roll plate (F) onto the bottom of the air springs (Fig. 10).



Fig. 10

- Insert two 3/8"-16 x 10" carriage bolts (K) through the square holes in the lower bracket main plate (B) (Fig. 11).

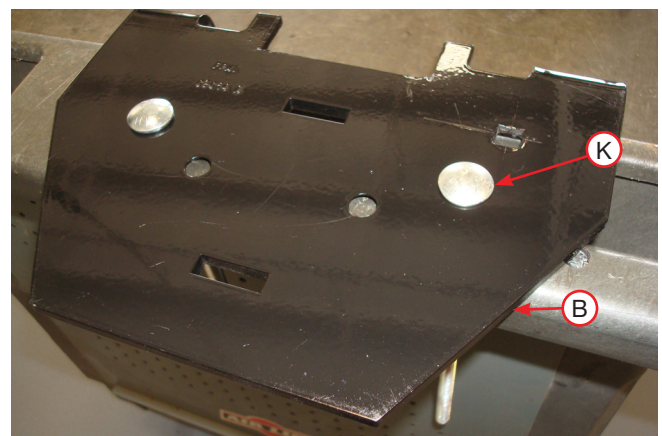

Fig. 11

- Set the lower bracket main plate assemblies onto the air springs with the roll plates installed. Attach with the 3/8"-24 x 3/4" flat-head socket-cap screws (S) (Fig. 12). Torque the hardware to no more than 20 lb.-ft. (27Nm).

NOTE

The flange on the lower bracket must be on the opposite side of the fitting that is located on the top of the air spring.

The flanges on the lower bracket must be installed so they are on the opposite side of the fitting that is on the top of the air spring.

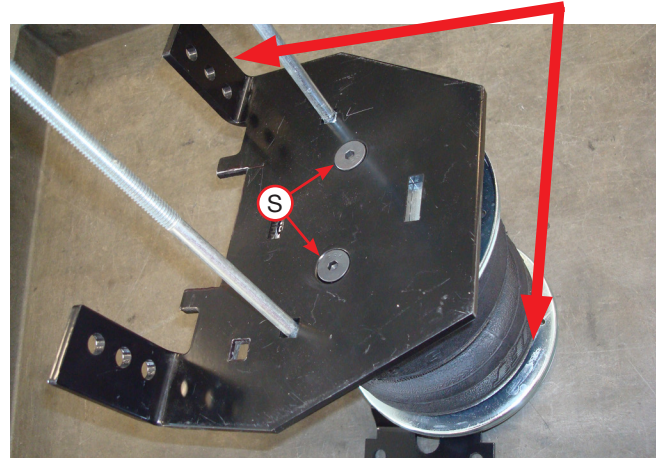

Fig. 12

- Insert the 3/8"-16 x 1" carriage bolt (I) (Fig. 13) through the top of the lower bracket. Flip over the assembly and install the lower bracket cup (C) onto the lower bracket main plate over carriage bolt and cap with serrated flange lock nut (Q) (Fig. 14). Snug bolt down but leave loose enough for the bracket to move freely in slot.

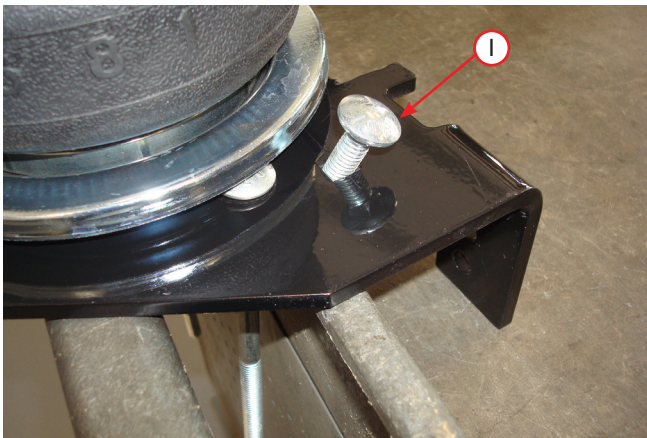

Fig. 13

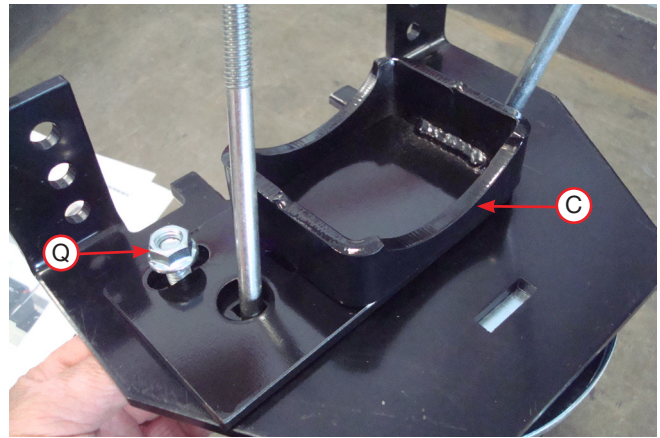

Fig. 14

7. Fig. 15 shows the driver's (left) side and passenger's (right) side assemblies.

Driver's (left)
side assembly

Passenger's (right)
side assembly

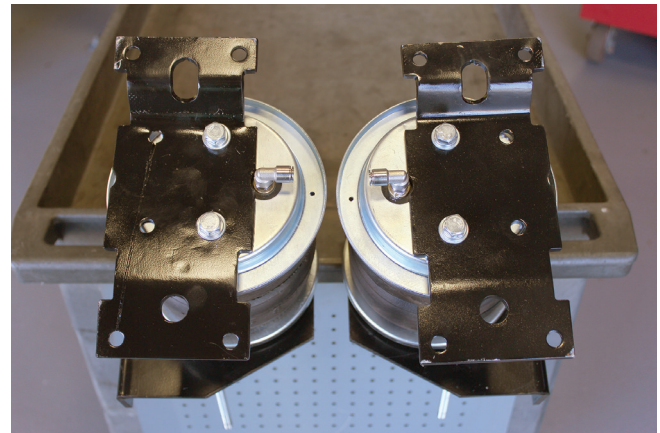

Fig. 15

INSTALLING THE AIR SPRING ASSEMBLIES

1. With the vehicle supported by safety stands, drop the axle or raise the body so that the assemblies can be put into position in between the axle and frame. Set the driver's (left) side and passenger's (right) side assemblies into position so that the lower bracket cup rests on the jounce bumper strike plate for single rear wheel (SRW) or the axle for dual rear wheel (DRW) applications.

NOTE

If there is a sway bar, insert the carriage bolts through the Clamp Bar (A) while setting the assemblies into position over the axle (see Fig. 19).

2. Push the lower bracket so that it is flush against the leaf spring stack. The flanges on the lower bracket main plate should lock on the sides of the U-bolt (Fig. 16).

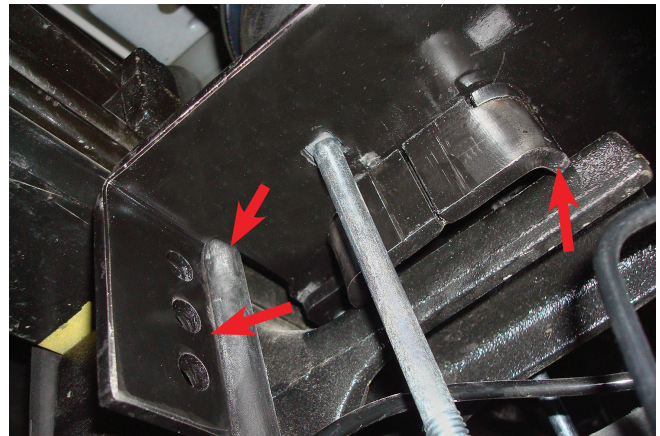

Fig. 16

NOTE

On the driver's (left) side, the long carriage bolt in the lower bracket main plate should be located between the hard brake line and axle (Fig. 22). On the passenger's (right) side, the carriage bolt should be located on the backside of the brake line (Fig. 23).

3. Install the U-bolts (H) around the stock U-bolt/leaf spring assembly and insert through the topmost holes in the lower bracket main plates (Fig. 17). Cap with the 3/8" serrated flange lock nut (Q). Snug bolts evenly, just enough to hold the lower bracket main plate flush against the stock U-bolts.

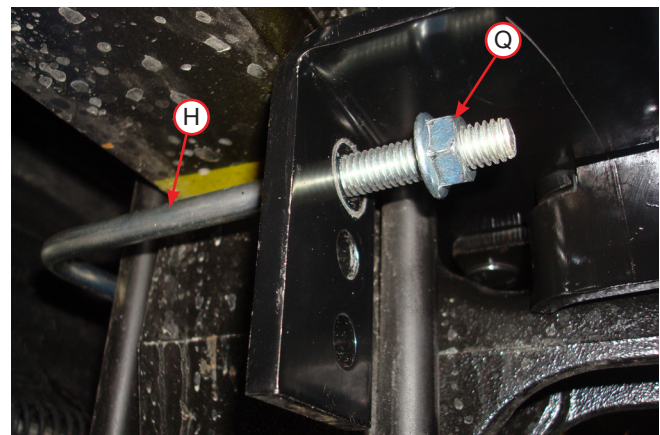
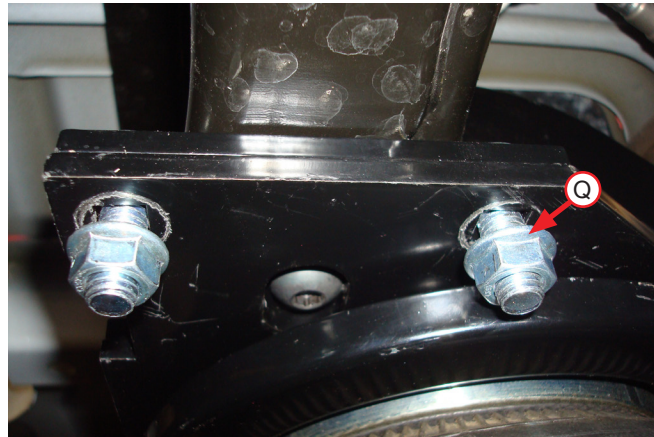

Fig. 17

- Before proceeding, ensure the 90 degree fittings each point inboard toward the center of the vehicle. While raising the axle or lowering the body of the vehicle, align the previously installed upper frame bracket carriage bolts with the air spring bracket holes so the carriage bolts protrude through the air spring bracket. Cap the carriage bolts with the 3/8" serrated flange lock nuts (Q) (Fig. 18). Snug the bolts down first then torque to 31 lb.-ft. (42Nm). Finish raising the axle or lowering the body and remove safety stands.

Fig. 18

- If not completed, set the lower clamp bars (A) over the carriage bolts located under the axle (Fig. 19). Attach with the 3/8" serrated flange lock nut (Q). Evenly torque the lower clamp bar hardware to 16 lb.-ft. (22Nm). Finish tightening the U-bolt hardware previously snugged by torquing to 10 lb.-ft. (14Nm).

TECH TIP

For sway bar applications it is acceptable to tighten the front carriage bolt hardware down more than the rear to gain more clearance on the sway bar. Also, it may be necessary to use a 9/16" crows foot adapter to properly torque the hardware.

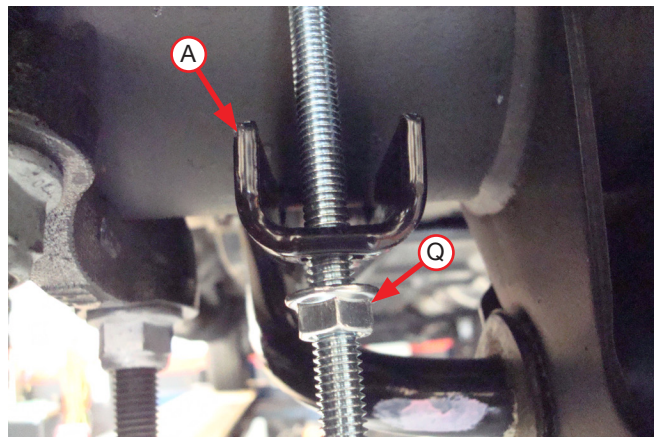
Fig. 19

- On vehicles that have a sway bar, cut the front carriage bolt just below the nut, so it does not contact the sway bar (Fig. 20).

Fig. 20

- Torque the nut (Q) to 32 lb.-ft. (43Nm) on both sides (Fig. 21).

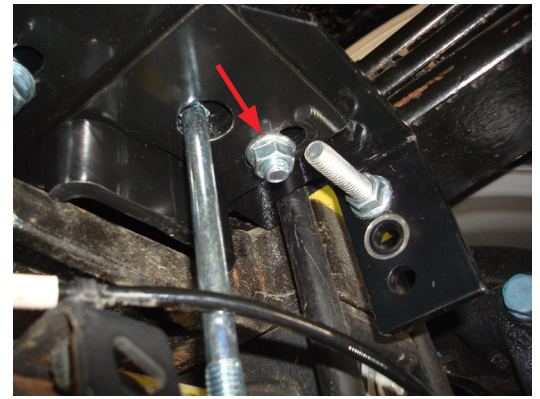

Fig. 21

- Once the lower brackets are secured, ensure the brake and ABS lines are not rubbing against the lower bracket carriage bolt. If necessary, pull or push the hard brake line away and tie off the ABS line to gain clearance.

NOTE

On the passenger side, it may be necessary to pull the ABS tree mount out of the top of the bracket. Re-attach by installing the tree mount to the back (Figs. 22 & 23).

CAUTION

PUSH THE HARD BRAKE LINE AWAY FROM THE LOWER BRACKET CARRIAGE BOLT IF THE LINE IS RESTING ON IT (FIG. 22 & FIG. 23).

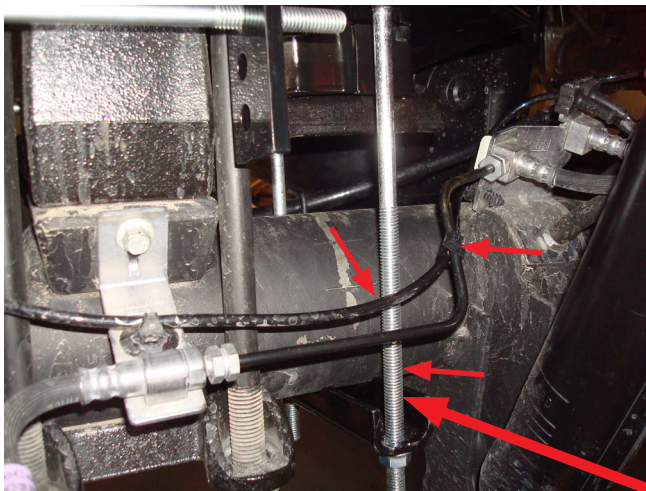

Fig. 22

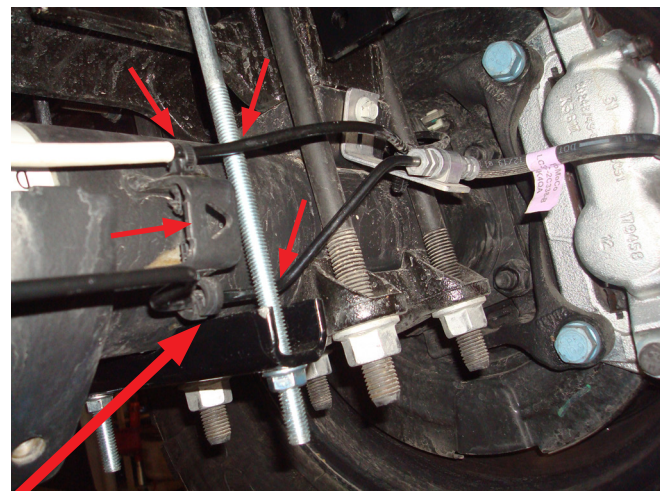

Fig. 23

Brake or ABS lines must not rub against the carriage bolt. Push or pull hard line out of the way. Move or zip tie ABS line out of the way.

Installing the Air Lines

Air lines are routed from the air springs to Schrader valves. LoadLifter 5000 series air lines come in two styles: nylon and braided stainless steel. Begin by choosing locations for the Schrader valves and drill a 5/16" (8mm) hole, if necessary (Fig. 24).

CAUTION

KEEP AT LEAST 6" (150MM) OF CLEARANCE BETWEEN ALL AIR LINES AND THE EXHAUST SYSTEM. AVOID SHARP BENDS AND EDGES.

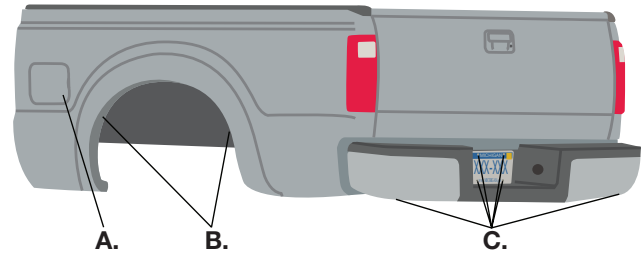

* For LoadLifter 5000 Ultimate Plus kits, the recommended location for the Schrader valves is the rear bumper area or license plate.

A. Inside fuel tank filler door B. Inside rear wheel wells C. License plate or rear bumper area*

Fig. 24

INSTALLING NYLON AIR LINES

1. Cut the air line in half. Make clean, square cuts with a razor blade or hose cutter (Fig. 25). Do not use scissors or wire cutters.
2. Use zip ties to secure the air line to fixed points along the chassis. Do not pinch or kink the air line. The minimum bend radius for the air line is 1" (25mm). Leave at least 2" (51mm) of slack in the air line to allow for any movement that might pull on the air line.
3. Install the Schrader valve in the chosen location (Fig. 26).

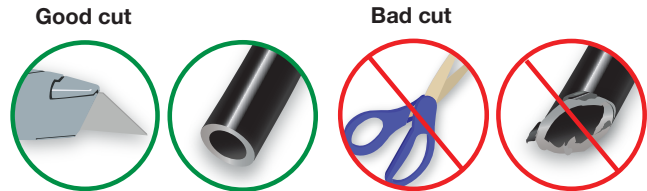

Fig. 25

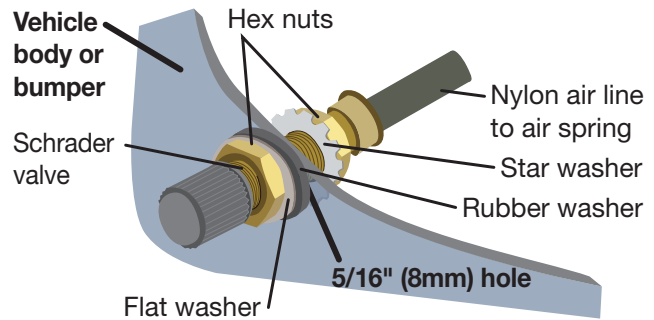

Fig. 26

INSTALLING BRAIDED STAINLESS STEEL AIR LINES

CAUTION

KEEP THE AIR LINE AWAY FROM THE FUEL LINE, BRAKE LINES AND ELECTRICAL WIRES.

1. Use zip ties to secure the air line to fixed points along the chassis every 6" to 8" (152 to 203mm). Leave at least 2" (51mm) of slack to allow for any movement that might pull on the air line.
2. Tighten the air line hex nut finger-tight, then use 2 wrenches to turn 1 additional flat (1/6 of one full turn). **Do not overtighten** (Fig. 27 or Fig. 28). The easiest way to tighten the fitting is off the vehicle. Install the Schrader valve in the chosen location.
3. Coil and secure any excess air line in an area where it will not be susceptible to damage. The braided stainless steel air line cannot be trimmed.

Air Line Setup Without Compressor System

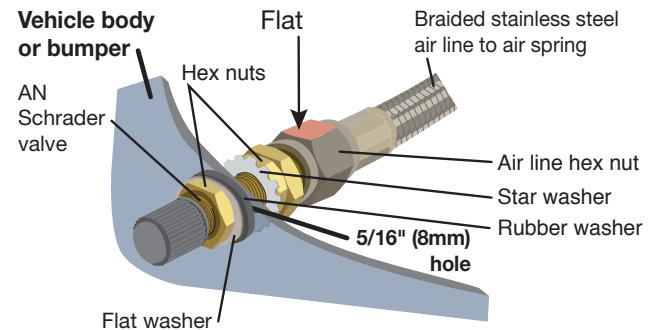

Fig. 27

Air Line Setup for Compressor Integration

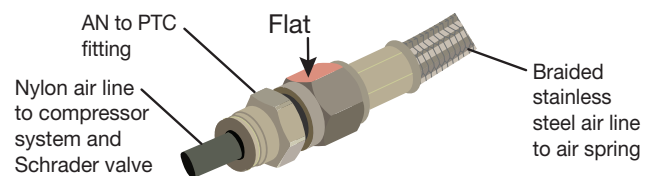

Fig. 28

INSTALLING THE HEAT SHIELD

1. Attach the metal heat shield to the exhaust where it is closest to the air spring. Slide the air line thermal sleeve over the nylon air line and place it where the air line is closest to the exhaust (Fig. 29).

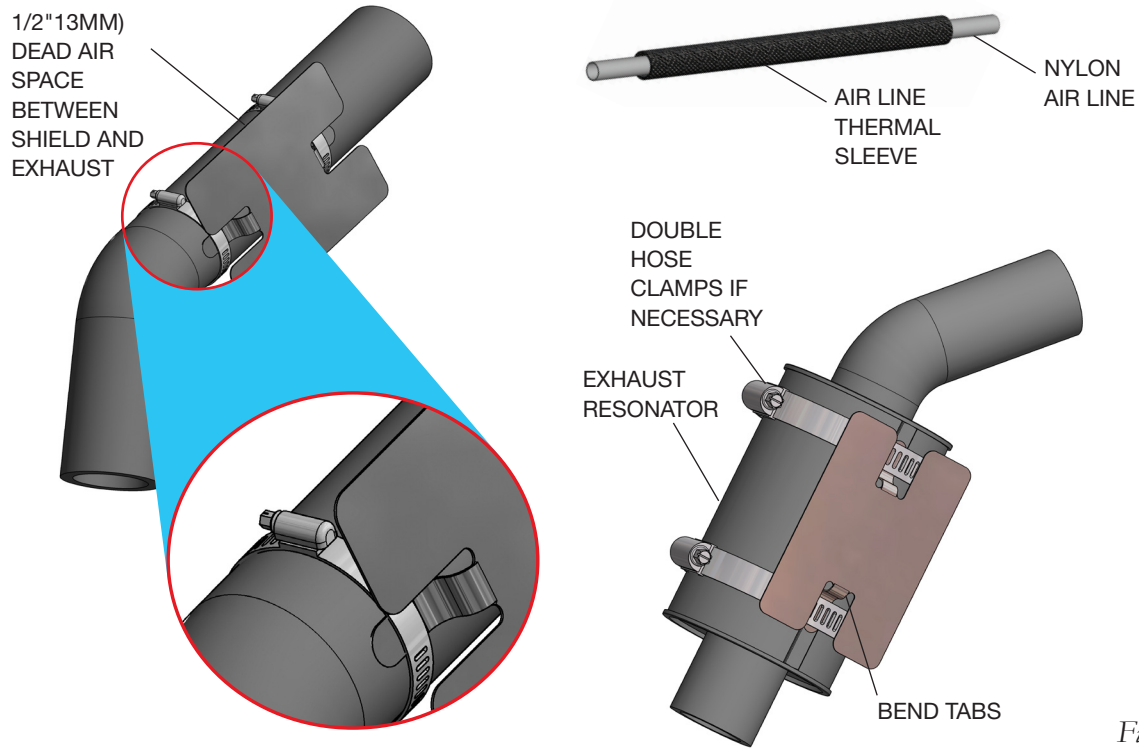
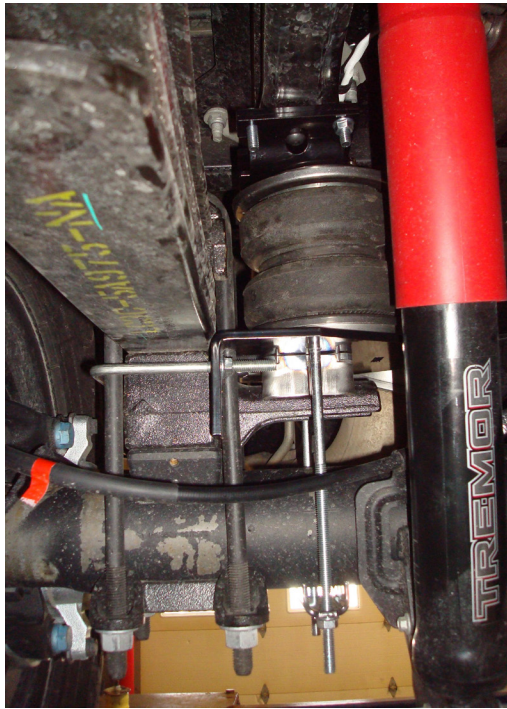

Fig. 29

Finished Installation

These images show the finished installation of both sides for the F-250 and F-350 single rear wheel (SRW) applications (Figs. 30-33).



Passenger's (right) side front view *Fig. 30*



Passenger's (right) side inside frame view *Fig. 31*

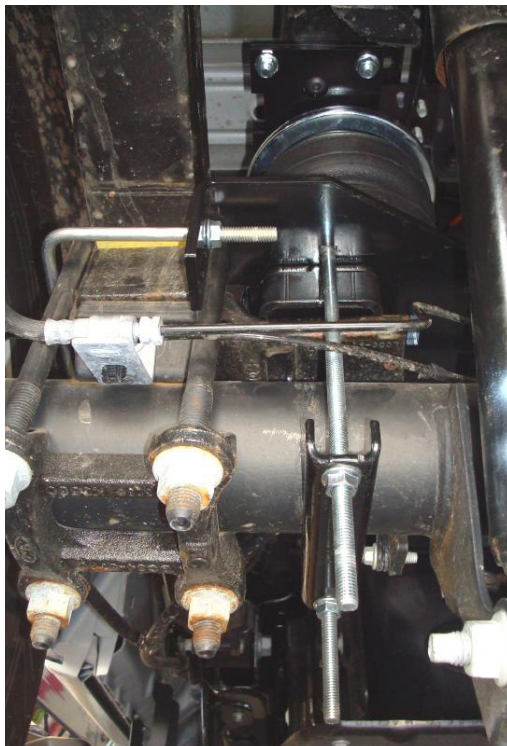

Driver's (left) side rear view *Fig. 32*

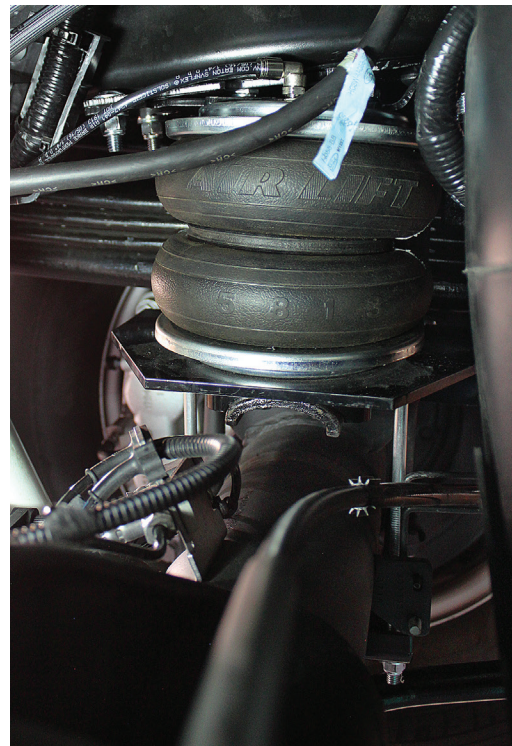

Driver's (left) side inside frame view *Fig. 33*

INSTALLATION CHECKLIST

- Clearance test** — Inflate the air springs to 40-60 PSI (2.8-4.1BAR) and make sure there is at least 1/2" (13mm) clearance from anything that might rub against each sleeve. Be sure to check the tire, brakes, frame, shock absorbers and brake cables.
- Leak test before road test** — Inflate the air springs to 40-60 PSI (2.8-4.1BAR) and check all connections for leaks. All leaks must be eliminated before the vehicle is road tested.
- Heat test** — Be sure there is sufficient clearance from heat sources, at least 6" (152mm) for air springs and air lines. If a heat shield was included in the kit, install it. If there is no heat shield, but one is required, call Air Lift customer service at (800) 248-0892.
- Fastener test** — After 500 miles (800km), recheck all bolts for proper torque.
- Road test** — The vehicle should be road tested after the preceding tests. Inflate the air springs to recommended driving pressures. Drive the vehicle 10 miles (16km) and recheck for clearance, loose fasteners and air leaks.
- Operating instructions** — If professionally installed, the installer should review the operating instructions with the owner. Be sure to provide the owner with all of the paperwork that came with the kit.

MAINTENANCE AND USE GUIDELINES

1. Check air pressure weekly.
2. Always maintain normal ride height. Never inflate beyond 100 PSI (7BAR).
3. If the system develops an air leak, use a soapy water solution to check all air line connections and the inflation valve core before deflating and removing the air spring.

Minimum Recommended Pressure
5 PSI (.34BAR)

Maximum Air Pressure
100 PSI (7BAR)

CAUTION

FOR SAFETY AND TO PREVENT POSSIBLE DAMAGE TO THE VEHICLE, DO NOT EXCEED MAXIMUM GROSS VEHICLE WEIGHT RATING (GVWR) OR PAYLOAD RATING, AS INDICATED BY THE VEHICLE MANUFACTURER. ALTHOUGH THE AIR SPRINGS ARE RATED AT A MAXIMUM INFLATION PRESSURE OF 100 PSI (7BAR), THE AIR PRESSURE ACTUALLY NEEDED IS DEPENDENT ON LOAD AND GROSS VEHICLE WEIGHT RATING.

Load**Lifter**[™] series

Ride**Control**[™]

Air Lift **1000** HD[™]

Air Lift **1000**[™]



User Guide

Which kit is on the vehicle?

LoadLifter 5000 Ultimate Plus

Stainless steel roll plates, braided stainless steel air lines



LoadLifter 5000 Ultimate

Black powder-coated steel roll plates



LoadLifter 5000

Zinc-coated steel roll plates



LoadLifter 7500XL

"5815" on side of air springs



RideControl

Sleeve-style air springs



Air Lift 1000HD

Black air springs inside coil springs



Air Lift 1000

Red air springs inside coil springs



MY PRESSURE SETTINGS

Left

Right

Both

Camper _____

Boat trailer _____

Utility trailer _____

Work trailer _____

Max pressure _____

Vehicle

Ex. 2017 Ford F-250 Super Duty

Installed kit

Ex. LoadLifter 5000 Ultimate

Index

Introduction, Notation Explanation, Important Safety Notice	4
LoadLifter, RideControl Pressure Settings, Guidelines for Use.....	5
Air Lift 1000HD, Air Lift 1000 Pressure Settings, Guidelines for Use	6
Post-Installation Checklist, Maintenance Guidelines	7
Finding Air Leaks, Fixing Air Leaks on Barbed Fittings	8
Cutting Air Lines.....	9
Fixing Air Leaks on PTC Fittings, Fixing Air Leaks on Braided Stainless Steel Air Lines.....	10
Adjusting Air Pressure	11
Choosing the Right On-Board Air Compressor System	12
Troubleshooting Guide, Frequently Asked Questions	14
Limited Warranty and Return Policy, Replacement Part Information	15

INTRODUCTION

Thank you for purchasing an Air Lift product. It is important to read and understand the entire User Guide before operating the Air Lift system.

Air Lift Company reserves the right to make changes and improvements to its products and publications at any time.

NOTATION EXPLANATION

This kit does not alter the gross vehicle weight rating (GVWR) or payload of the vehicle. Check the vehicle's safety compliance certification

label or the owner's manual and do not exceed the maximum load listed for this vehicle.

Gross vehicle weight rating (GVWR): The maximum allowable weight of the fully loaded vehicle (including passengers and cargo). This number — along with other weight limits, as well as tire, rim size and inflation pressure data — is shown on the vehicle's Safety Compliance Certification Label.

Payload: The combined, maximum allowable weight of cargo and passengers that the vehicle is designed to carry. Payload is GVWR minus the base curb weight.



INDICATES IMMEDIATE HAZARDS WHICH WILL RESULT IN SEVERE PERSONAL INJURY OR DEATH.



INDICATES HAZARDS OR UNSAFE PRACTICES WHICH COULD RESULT IN SEVERE PERSONAL INJURY OR DEATH.



INDICATES HAZARDS OR UNSAFE PRACTICES WHICH COULD RESULT IN DAMAGE TO THE MACHINE OR MINOR PERSONAL INJURY.

IMPORTANT SAFETY NOTICE



FOR SAFETY AND TO PREVENT POSSIBLE DAMAGE TO THE VEHICLE, DO NOT EXCEED MAXIMUM GROSS VEHICLE WEIGHT RATING (GVWR), AS INDICATED BY THE VEHICLE MANUFACTURER.

LOADLIFTER, RIDECONTROL PRESSURE SETTINGS

Minimum Air Pressure	Maximum Air Pressure*
5 PSI (.34BAR)	100 PSI (7BAR)
<div style="display: flex; align-items: center;"> <div style="background-color: #ffff00; padding: 5px; margin-right: 10px;"> CAUTION </div> <p>FAILURE TO MAINTAIN CORRECT MINIMUM PRESSURE (OR PRESSURE PROPORTIONAL TO LOAD) COULD LEAD TO PREMATURE AIR SPRING FAILURE AND WILL VOID THE WARRANTY.</p> </div>	

* Check Installation Guide for maximum pressure for this kit.

GUIDELINES FOR USE

1. Check air pressure weekly.
2. Never inflate to more than 100 PSI (7BAR).
3. Operating the vehicle below the minimum air spring pressure will void the Air Lift warranty.
4. Always add pressure to the air springs in small quantities, checking the pressure frequently.
5. When increasing load, always adjust pressure to maintain normal or desired ride height. Increase or decrease pressure from the system as necessary to attain normal ride height for optimal ride and handling.

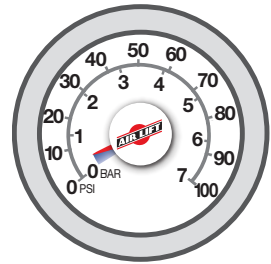

Minimum pressure **5 PSI**
at all times **.34BAR**

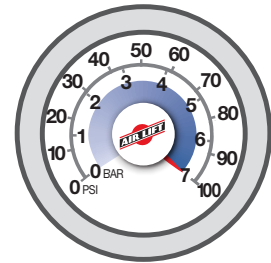

Max **100 PSI**
pressure **7BAR**

AIR LIFT 1000HD, AIR LIFT 1000 PRESSURE SETTINGS

Minimum Air Pressure	Maximum Air Pressure*
5 PSI (.34BAR)	35 PSI (2.4BAR) OR 50 PSI (3.5BAR)
 CAUTION	FAILURE TO MAINTAIN CORRECT MINIMUM PRESSURE (OR PRESSURE PROPORTIONAL TO LOAD) COULD LEAD TO PREMATURE AIR SPRING FAILURE AND WILL VOID THE WARRANTY.

* Check Installation Guide for maximum pressure for this kit.

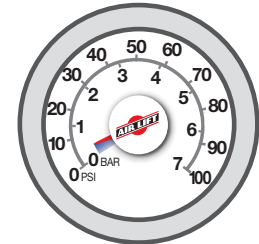

Minimum pressure **5 PSI**
at all times **.34BAR**

GUIDELINES FOR USE

1. Check air pressure weekly.
2. Never inflate to more than the recommended maximum air pressure.
3. Operating the vehicle below the minimum air spring pressure will void the Air Lift warranty.
4. Always add air to springs in small quantities, checking the pressure frequently.
5. When increasing load, adjust air pressure to maintain normal ride height. Increase or decrease pressure from the system as necessary to attain normal ride height for optimal ride and handling.

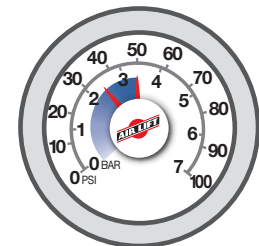

Max pressure **35 or 50 PSI**
2.4 or 3.5BAR

POST-INSTALLATION CHECKLIST

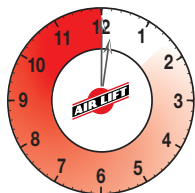

24-HOUR

Pressure check

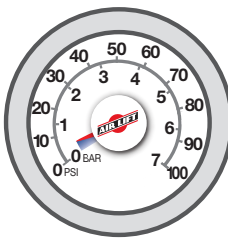

Minimum
pressure
at all times

**5 PSI
.34BAR**

- Overnight leak down test** — Recheck air pressure after the vehicle has been used for 24 hours. If the pressure has dropped more than 5 PSI (.34BAR), there could be a leak that may need to be fixed. See page 8 for tips on finding air leaks.
- Air pressure requirements** — It is important to understand the air pressure requirements of the air spring system. Regardless of load, the air pressure should be adjusted to maintain

MAINTENANCE GUIDELINES

1. Periodically check the air spring system fasteners for tightness (torque specifications can be found in the Installation Guide). Also, check the air springs for any signs of rubbing. Realign the air spring components, if necessary.

adequate ride height at all times while driving.

- Thirty-day or 500-mile (800km) test** — Recheck the air spring system after 30 days or 500 miles (800km), whichever comes first. If any part shows signs of rubbing or abrasion, the source should be identified and moved, if possible. If it is not possible to relocate the cause of the abrasion, the air spring may need to be remounted. If professionally installed, the installer should be consulted. Check all fasteners for tightness. Consult the installation guide for the kit for proper torque specifications if any fasteners have loosened.

00050mi

OR

30
days

FINDING AIR LEAKS

1. Inflate the air springs to 30 PSI (2.1BAR).
2. Spray all connections with a solution of liquid dish soap and water. Wait 30 seconds and check for bubbles which indicate leaks.
3. Check the air pressure again after 24 hours. A 2-4 PSI (.14-.28BAR) loss after initial installation is normal. Retest for leaks if the loss is more than 5 PSI (.34BAR).
4. After checking for leaks, deflate the air springs to the minimum pressure required to restore the system to normal ride height.

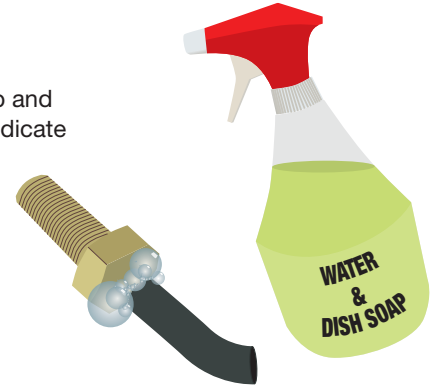

FIXING AIR LEAKS ON BARBED FITTINGS

1. If there is a leak at the Schrader valve, tighten the valve with a valve core tool.
2. If there is a leak at any barbed fitting, cut the air line 1 1/2" (38mm) behind the fitting. Use a pair of pliers or locking pliers to twist and pull the air line off of the fitting. Do not cut the air line lengthwise at the fitting because this could nick the barbs, likely causing it to leak.
3. Reinstall the air line and the air line clamp if the fitting has one. Make sure the air line covers all barbs.
4. See "Cutting Air Lines," page 9. For push-to-connect (PTC) fittings and stainless steel braided air lines, see page 10.



CUTTING AIR LINES

When cutting air lines, use a sharp knife or a hose cutter and make clean, square cuts. Do not use scissors or wire cutters because these tools will deform the air line, causing it to leak around fittings. Do not cut the lines at an angle.

The maximum bend radius for 1/4" air line is 1" (25mm). Do not bend the air line more than the maximum bend radius or side load the fitting connections. Air lines are to be installed straight into fittings.

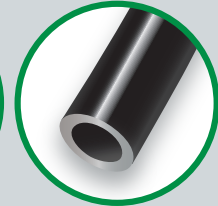
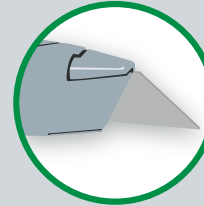

FIXING AIR LEAKS ON PTC FITTINGS

After insertion, check the PTC fitting connection by pulling on each line to verify a robust connection.

To release the air line from the connection, first release all air from the system. Push in on the air

line (step 1), push the collar in (step 2), and with the collar depressed, pull the air line out of the fitting (step 3).

To reconnect, push the air line into the fitting and pull to verify a robust connection.

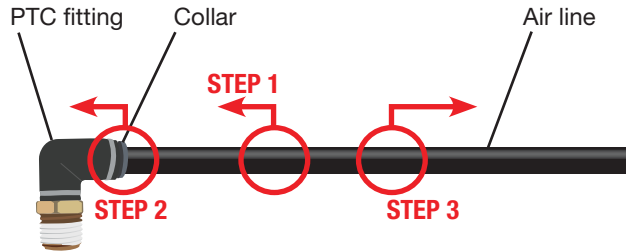

Tips

- To ensure a proper seal, cut off the end of the air line just beyond the witness mark before reinstalling in the fitting.
- If fitting is leaking at the threads, it may be necessary to remove and re-apply thread sealant on the threads and re-install 1 1/2 turns beyond finger tight.

FIXING AIR LEAKS ON BRAIDED STAINLESS STEEL AIR LINES

1. Disconnect the air line where it is leaking.
2. Check the mating surface on the fitting for burrs and remove if possible. If there are dings or indentations on the fitting mating surface, it may continue to leak and may need to be replaced.
3. To re-assemble, tighten the fitting one flat — or 1/6 of a full rotation — past finger tight.
4. Contact Air Lift customer service if the fitting continues to leak.

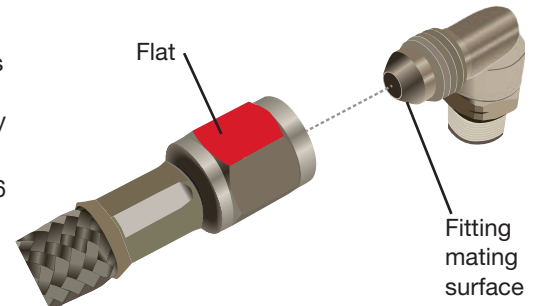

ADJUSTING AIR PRESSURE

The air springs should be adjusted for three factors: stability, level vehicle, ride comfort.

Stability

Stability translates into safety and should be the priority, meaning the driver may need to sacrifice a level and comfortable ride. Stability issues include roll control, bounce, dive during braking and sponginess. Tuning out these problems usually requires an increase in pressure.



Sway and body roll

Level vehicle

Use air pressure to raise the end of the vehicle that is squatting back to its normal ride height. It may be necessary to apply more air pressure to one side if the load is uneven. If the vehicle has a single-path air control system, redistribute the load side to side.

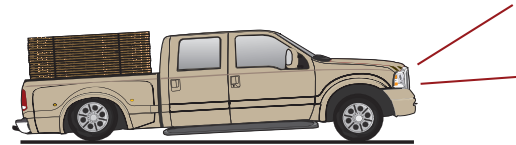

Bad headlight aim

Ride comfort

If the vehicle has a rough ride, it may be due to either too much air pressure or not enough. Experiment with different ride pressures, so long as it doesn't impact vehicle stability.

- If the vehicle feels like it is bottoming out, increase air pressure.
- If the headlights are aimed too high, try increasing air pressure in the rear air springs.
- When in doubt, add air.
- If the front of the vehicle dives while braking, increase the pressure in the front air springs, if equipped.

CHOOSING THE RIGHT ON-BOARD AIR COMPRESSOR SYSTEM

Add an on-board air compressor system to inflate and deflate the air springs with the touch of a button — from inside of the vehicle or outside (wireless systems).

- For convenient, on-the-go control of the air springs, add an Air Lift on-board air compressor system.
- Air Lift on-board air compressor systems eliminate the search for gas stations that have a working compressor, saving time, energy and money.
- All systems include a compressor, controller and all parts needed for easy installation.

1. Choose single- or dual-path inflation

2. Choose wireless or analog or automatic control

- **Wireless:** Control the air springs from inside or outside the vehicle. Easiest installation — no wires or hoses to the cab.
- **Automatic:** Air spring pressure is automatically adjusted based on ride height.
- **Analog:** In-cab control of the air springs. Economically priced.

3. Choose heavy- or standard-duty compressor

- **Standard duty:** A standard-duty compressor will work well for most customers who use their system on an intermittent basis.
- **Heavy duty:** For daily use, consider the heavy-duty compressor — it inflates faster and more quietly than the standard compressor.

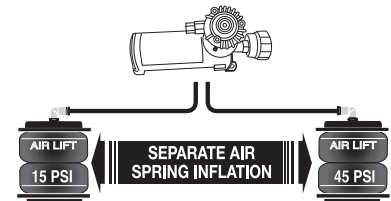

Dual-path systems: Air springs are controlled separately to allow for different air pressure from side to side. Perfect for uneven or top-heavy loads.

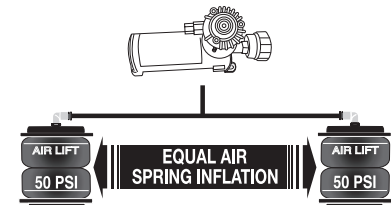

Single-path systems: Two springs will inflate at the same time. Good for loads that are evenly distributed from left to right.

ON-BOARD AIR COMPRESSOR SYSTEMS

WIRELESS CONTROL



Wireless**ONE**™

No wires or hoses to
the inside of the cab

Single Path **P/N 25870**



Wireless**AIR**™

Premium system for independent
control of each side

Dual Path **P/N 72000**

AUTOMATIC LOAD LEVELING



Smart**Air**™ II

Level every time

Single Path **P/N 25490**

Dual Path **P/N 25491**

ANALOG LOAD LEVELING



Load**Controller**™

Analog in-cab control

Single Path

SD **P/N 25850**

HD **P/N 25854**

Dual Path

SD **P/N 25852**

HD **P/N 25856**

TROUBLESHOOTING GUIDE

PROBLEM	CAUSE	SOLUTION
System won't maintain pressure overnight	Improperly installed air line, air line has holes or cracks, hole in air spring	Leak test all air line connections, threaded connections (if equipped), and all fittings in the control system (if equipped). Contact customer service regarding air spring failure.
Air spring or air line leak	Fitting seal or air line is compromised	Check to make sure air lines are seated in the fittings. Inspect fittings with soapy water. Trim hose or re-seal fitting. Ensure lines are cut straight.
One or more air springs won't inflate	Kink or fold in the air line, control system malfunction, inflation valve plugged	Replace any air line that has been kinked. Check control system function by disconnecting an air line, operating the system and checking for air pressure.

FREQUENTLY ASKED QUESTIONS

Q. Will installing air springs increase the weight ratings of a vehicle?

No. Adding air springs will not change the gross vehicle weight rating (GVWR) of a vehicle. Exceeding the GVWR is dangerous and voids the Air Lift warranty.

Q. Is it necessary to keep air in the air springs at all times and how much pressure will they need?

The recommended minimum air pressure is 5 PSI (.34BAR) for all air springs. This helps the air spring maintain its shape and, on some kits, prevents bottoming out.

Q. Is it necessary to add a compressor system to the air springs?

No. Air pressure can be adjusted with any

type of compressor as long as it can produce sufficient pressure to service the air springs. Even a bicycle tire pump can be used.

Q. How long should air springs last?

If the air springs are properly installed and maintained they should last indefinitely.

Q. Will raising the vehicle on a hoist for service work damage the air springs?

No. For short-term service work such as tire rotation or oil changes, the vehicle can be lifted on a frame hoist with the air springs set to their minimum pressure. However, if the vehicle will be on the hoist for a prolonged period of time, support the axle with jack stands in order to take the tension off of the air springs.