

QuickSHOT™
by AIR LIFT™

Kit 25572
Onboard Compressor
Control System

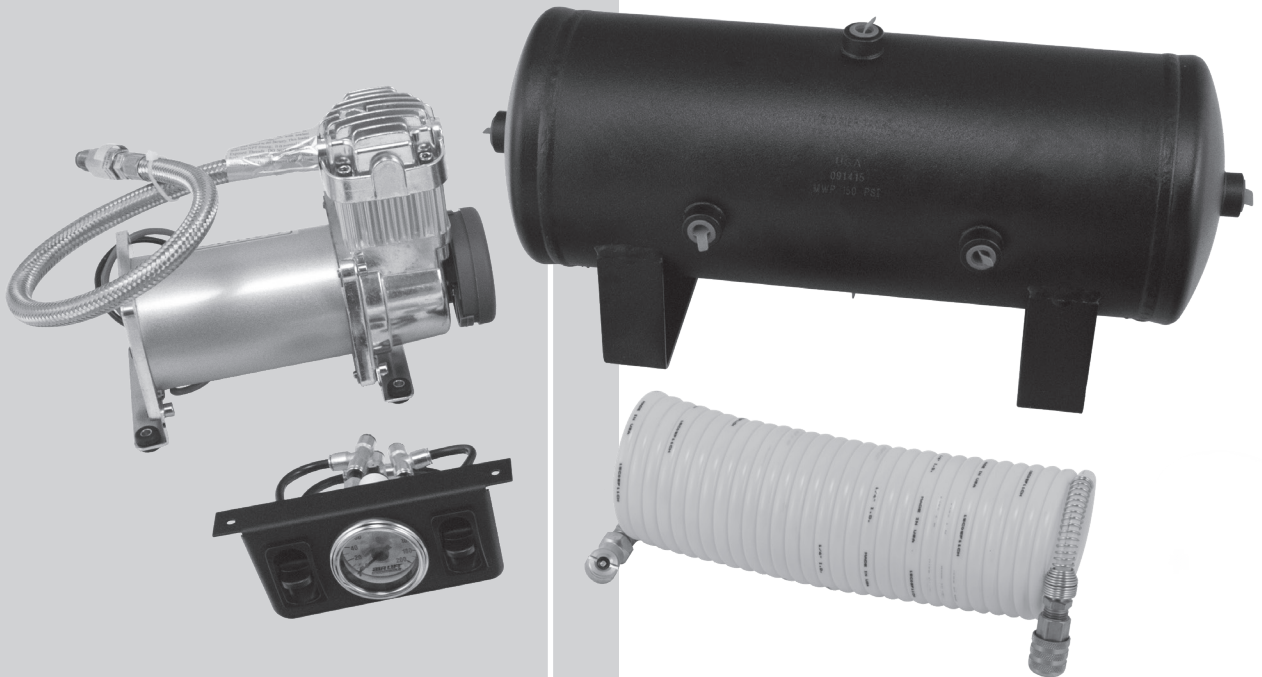

INSTALLATION GUIDE

For maximum effectiveness and safety, please read these instructions completely before proceeding with installation.

Failure to read these instructions can result in an incorrect installation.



TABLE OF CONTENTS

Introduction	2
Important Safety Notice	2
Notation Explanation	2
Installation Diagram	3
Installing the QuickShot System	4
Recommended Compressor Locations	4
Air Line Installation	5
Replacement Information	9



Introduction

The purpose of this publication is to assist with the installation, maintenance and troubleshooting of the QuickShot system.

It is important to read and understand the entire installation guide before beginning installation or performing any maintenance, service or repair. The information here includes step-by-step installation information.

Air Lift Company reserves the right to make changes and improvements to its products and publications at any time.

IMPORTANT SAFETY NOTICE

The installation of this kit does not alter the Gross Vehicle Weight Rating (GVWR) or payload of the vehicle. Check your vehicle's owner's manual and do not exceed the maximum load listed for your vehicle.

Gross Vehicle Weight Rating: The maximum allowable weight of the fully loaded vehicle (including passengers and cargo). This number — along with other weight limits, as well as tire, rim size and inflation pressure data — is shown on the vehicle's Safety Compliance Certification Label.

Payload: The combined, maximum allowable weight of cargo and passengers that the truck is designed to carry. Payload is GVWR minus the Base Curb Weight.

NOTATION EXPLANATION

Hazard notations appear in various locations in this publication. Information which is highlighted by one of these notations must be observed to help minimize risk of personal injury or possible improper installation which may render the vehicle unsafe. Notes are used to help emphasize areas of procedural importance and provide helpful suggestions. The following definitions explain the use of these notations as they appear throughout this guide.

INDICATES IMMEDIATE HAZARDS WHICH WILL RESULT IN SEVERE PERSONAL INJURY OR DEATH.



INDICATES HAZARDS OR UNSAFE PRACTICES WHICH COULD RESULT IN SEVERE PERSONAL INJURY OR DEATH.



INDICATES HAZARDS OR UNSAFE PRACTICES WHICH COULD RESULT IN DAMAGE TO THE MACHINE OR MINOR PERSONAL INJURY.



NOTE

Indicates a procedure, practice or hint which is important to highlight.

Installation Diagram

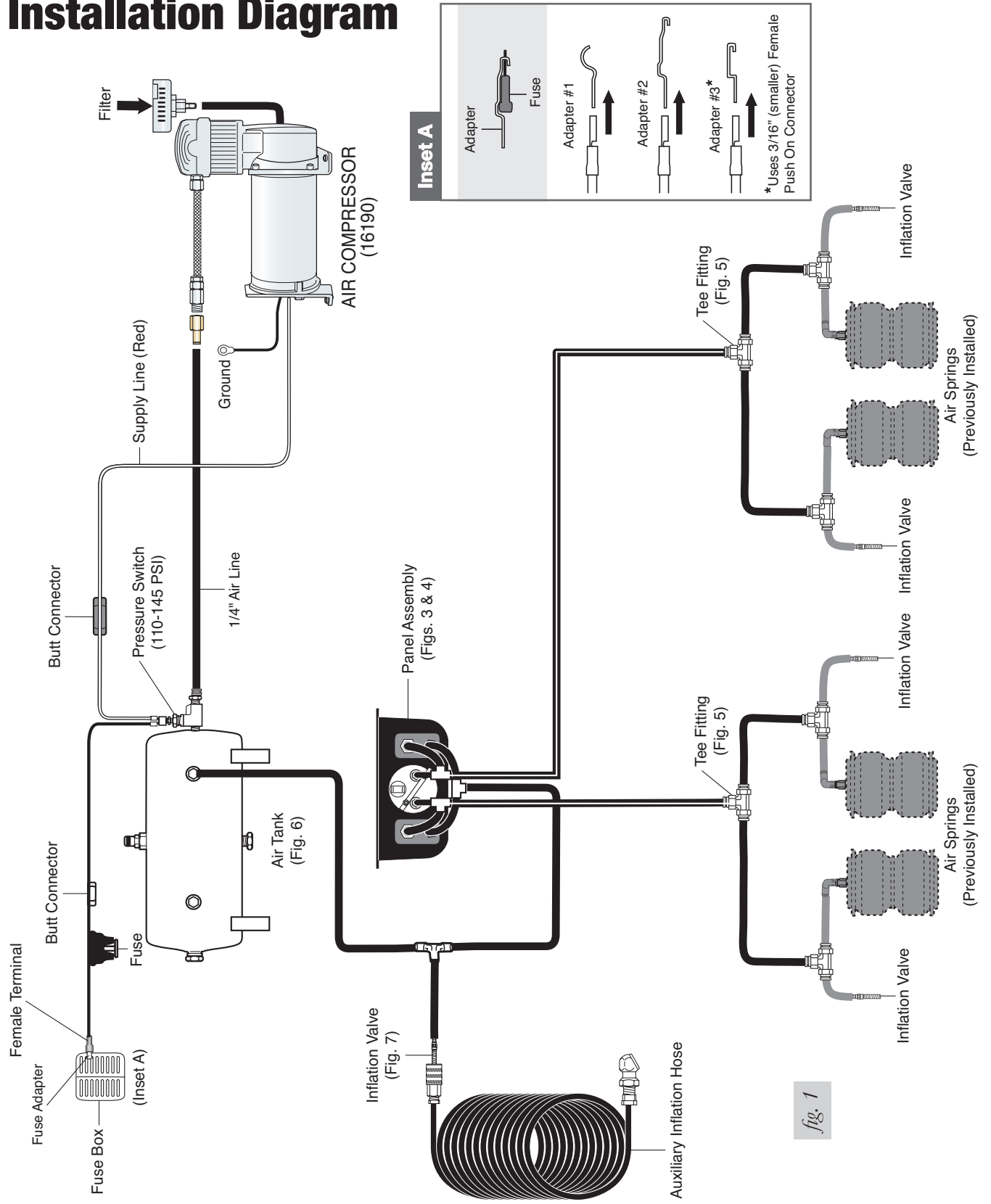

fig. 1

Installing the QuickShot System

RECOMMENDED COMPRESSOR LOCATIONS

Important

LOCATE COMPRESSOR IN DRY, PROTECTED AREA ON VEHICLE.
DIRECT SPLASH OR EXCESSIVE MOISTURE CAN DAMAGE
THE COMPRESSOR AND CAUSE SYSTEM FAILURE.

Disclaimer: If you choose to mount the compressor outside the vehicle please keep in mind the compressor body must be shielded from direct splash and the intake should be snorkeled inside the vehicle. If the compressor does not include a remote mount air filter or if mounting the compressor outside the vehicle, make sure to orient the compressor intake filter so that all moisture can easily drain.

Please also remember...

- To avoid high heat environments
- To avoid mounting the compressor under the hood.
- To check to be sure the compressor harness #2 will reach the compressor and connect to harness #1.
- The compressor can be mounted in any position — vertical, upside down, sideways, etc. (please refer to the instruction manual).

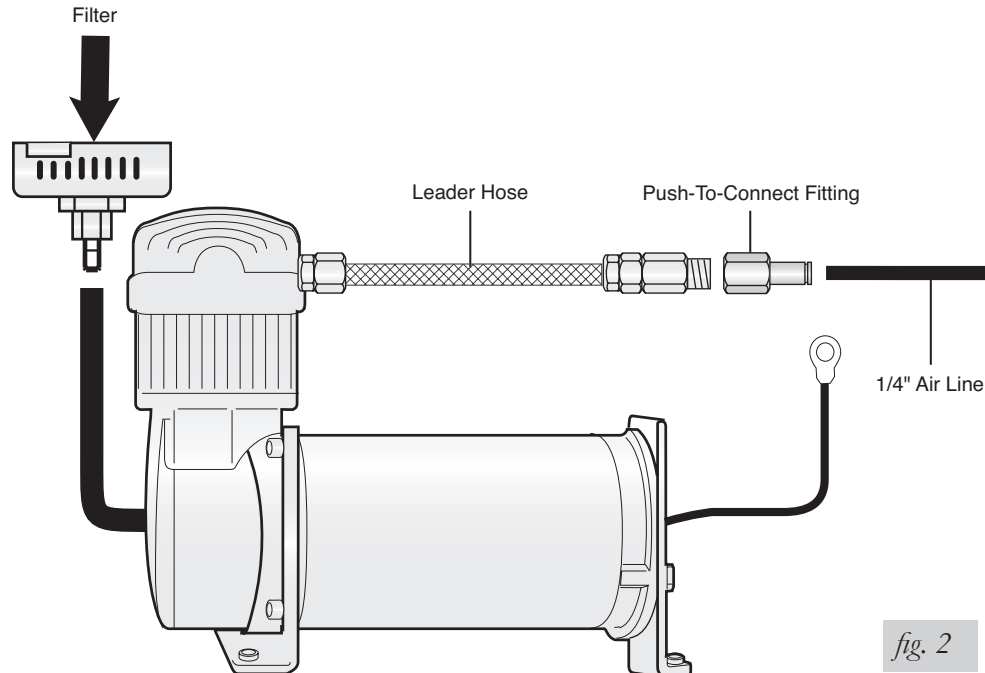

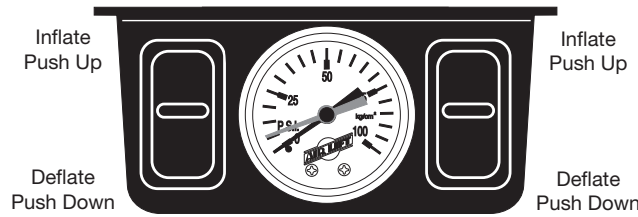

fig. 3

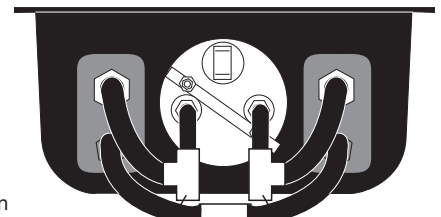

fig. 4

Air Lines to Air Springs To Tank Air Lines to Air Springs

AIR LINE INSTALLATION

Cut off excess air line squarely, using a sharp knife or air line cutter. Install the air line into the self locking fitting. Push and slightly turn the cut end of the air line into the fitting as far as it will go. A definite click can be heard and or felt when the air line is seated. The air line should go in approximately 9/16" (14mm).

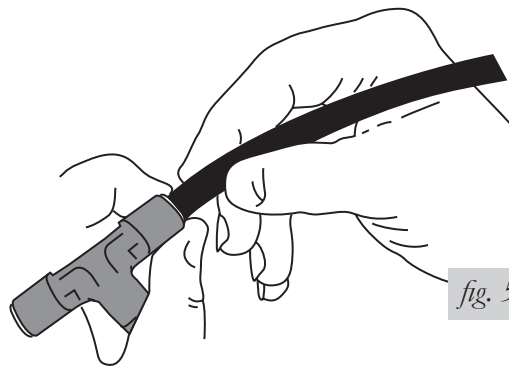

fig. 5

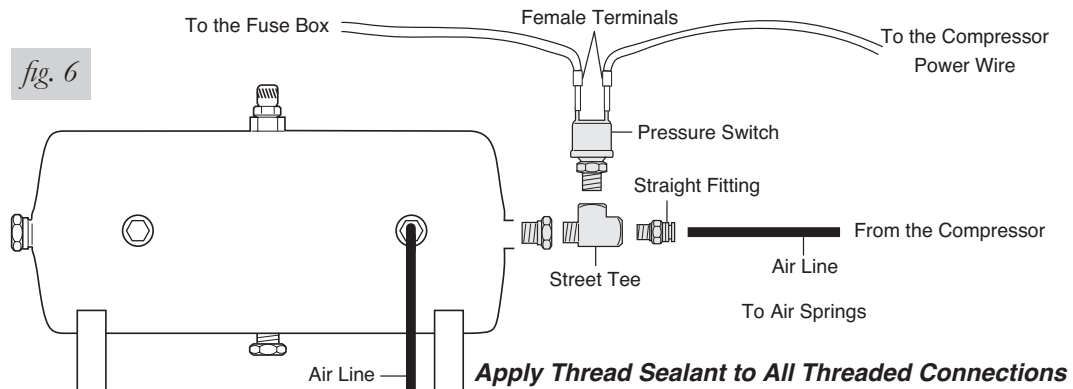

fig. 6

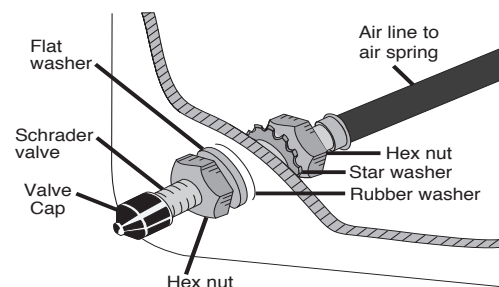

fig. 7

Replacement Part Information

If replacement parts are needed, contact Air Lift customer service. Most parts are immediately available and can be shipped the same day.

Contact Air Lift Company customer service at first if:

- Parts are missing from the kit.
- Need technical assistance on installation or operation.
- Broken or defective parts in the kit.
- Wrong parts in the kit.
- Have a warranty claim or question.

Contact the retailer where the kit was purchased:

- If it is necessary to return or exchange the kit for any reason.
- If there is a problem with shipping if shipped from the retailer.