



Installation Instructions / Quick start



Johnston Research & Performance, Inc.

1

What's in the box

Your Sprint Booster comes with the following components:

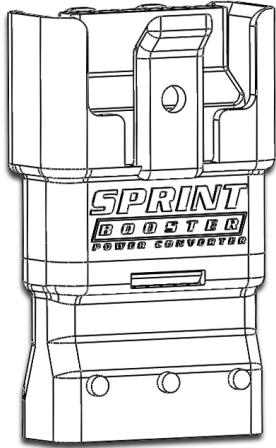

Sprint Booster device *



Selector Switch



Installation instructions/
Quick Start
(this document)



Double sided tape

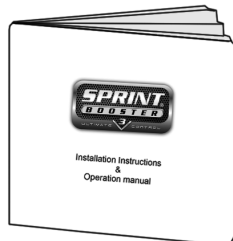

User guide



Tie wrap

* For reference only. The actual device may vary in shape and dimensions depending on the vehicle.

2

Choose the type of transmission

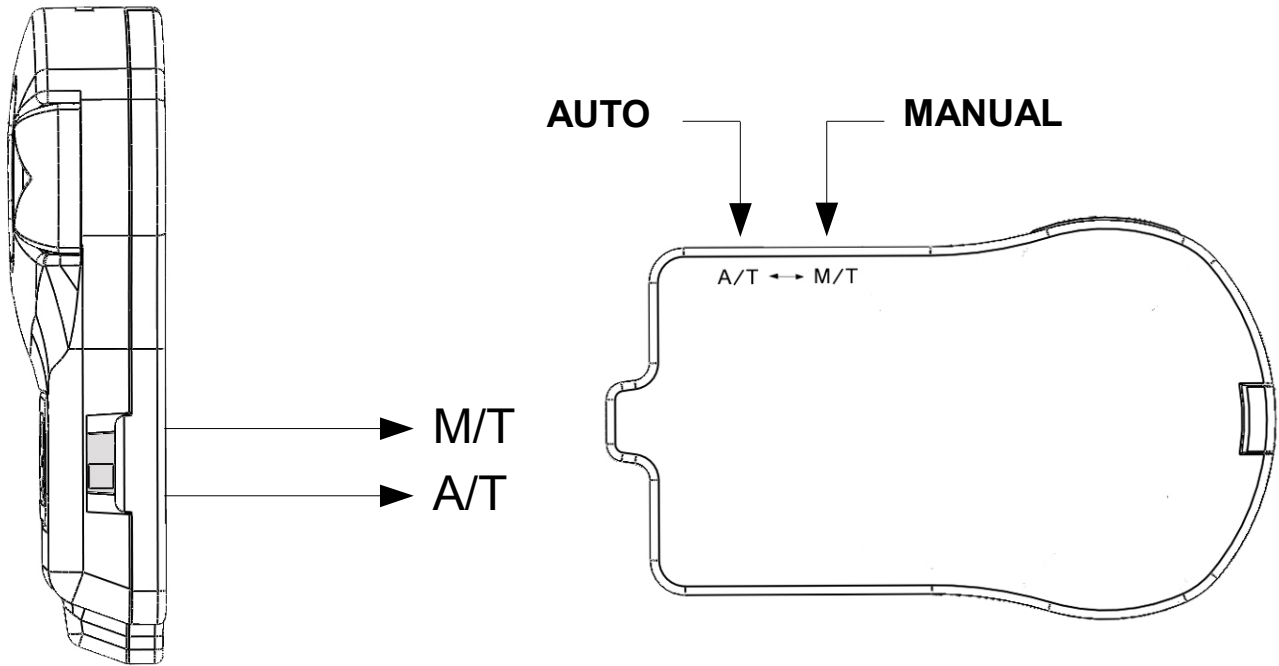

On the right side of the selector , there is a slide switch. Using a pointed object (pen/pin/paper clip..etc) move the switch to one of the 2 positions depending on the type of your vehicle's transmission.

Move to 'M/T' position for vehicles equipped with manual transmission or to 'A/T' position for vehicles equipped with automatic transmission.

For 'semi-automatic' transmissions (DCT, S tronic, DSG, PDK, SMG, ..etc) move to 'A/T' position

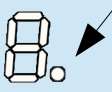
i When the slide switch is in the 'M/T' position (manual) a red dot will appear on the LED display indicating the selection of manual transmission once you operate the device. 



Never change this selection while driving.

3

Connecting the Selector Switch

As soon as you select the type of transmission, you will need to connect the Selector Switch to the Sprint Booster:

Locate the white socket on the Sprint Booster, take the Selector switch's connector and connect it to the Sprint Booster

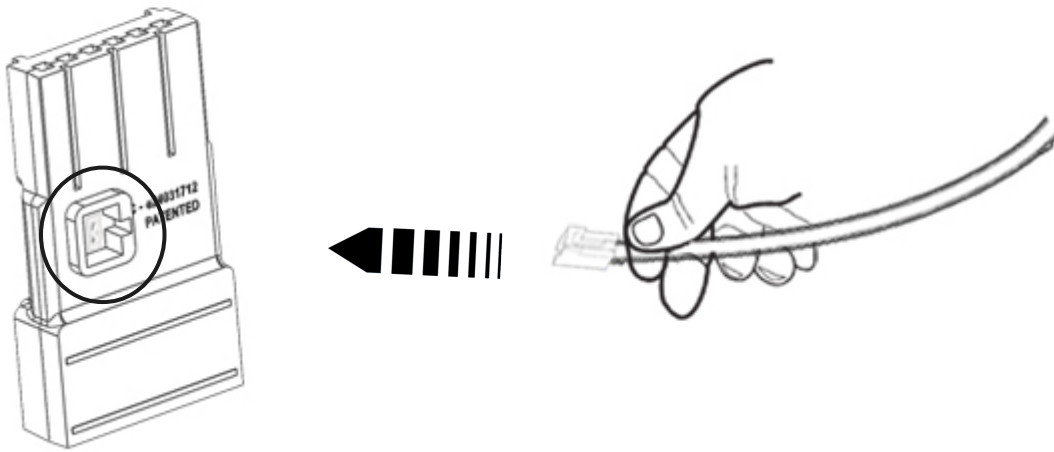

You also have the option not to connect the Selector Switch. In this case the device will work in factory defaults (📖 3). Acceleration mode/program selection , PEDAL LOCK mode & VALET mode cannot be selected without using the selector switch.



Never pull the connector from the wires.

4

Open the vehicle's door and remove the car keys from the car.

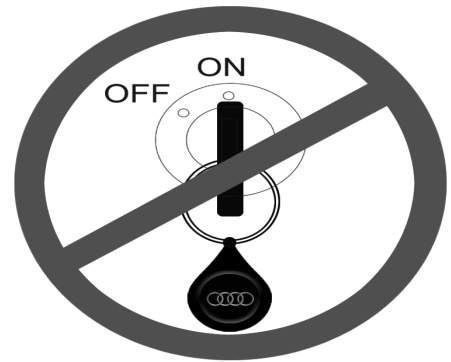
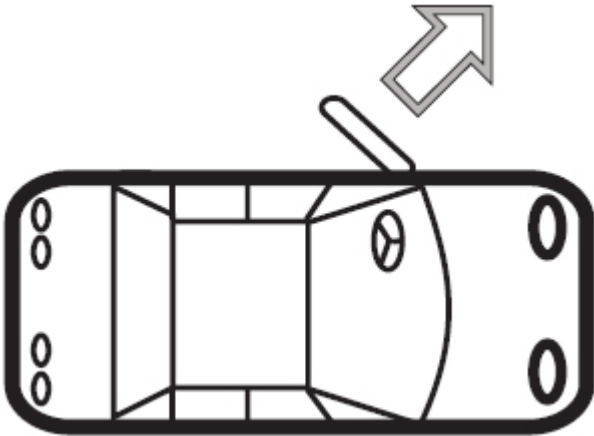

With the door open, wait for 10 minutes before you install the device. During this time, the vehicle checks the electronic systems of the car through the CAN bus system.

10 minutes

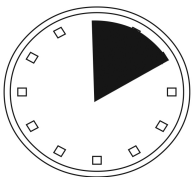

This step is important to allow the CAN bus system to complete the diagnostic testing and avoid having the check engine light switch On.

5

Installing Sprint Booster

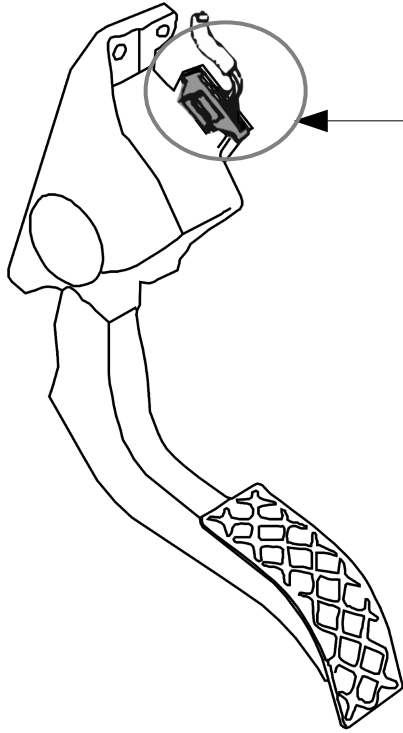

Locate the harness connector on the accelerator pedal.

Remove the harness connector from the pedal.

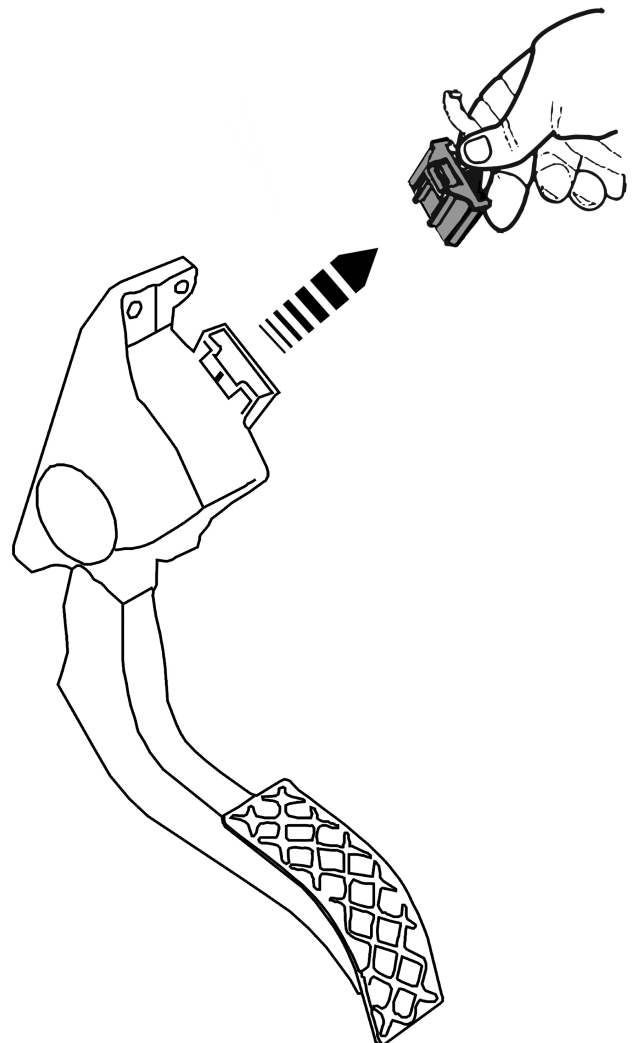

6

Connect the Sprint Booster on the pedal.

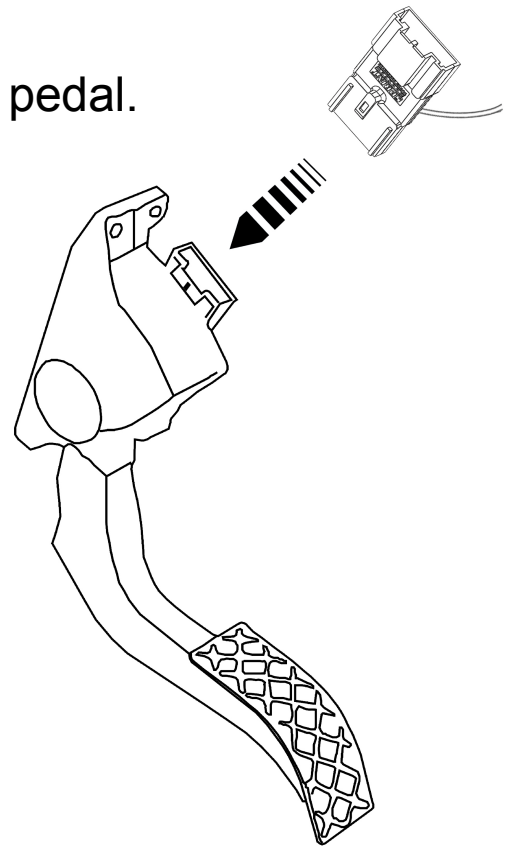

Make sure that the Sprint Booster is properly aligned with the pedal's connector during installation.

Connect the harness connector on the Sprint Booster.

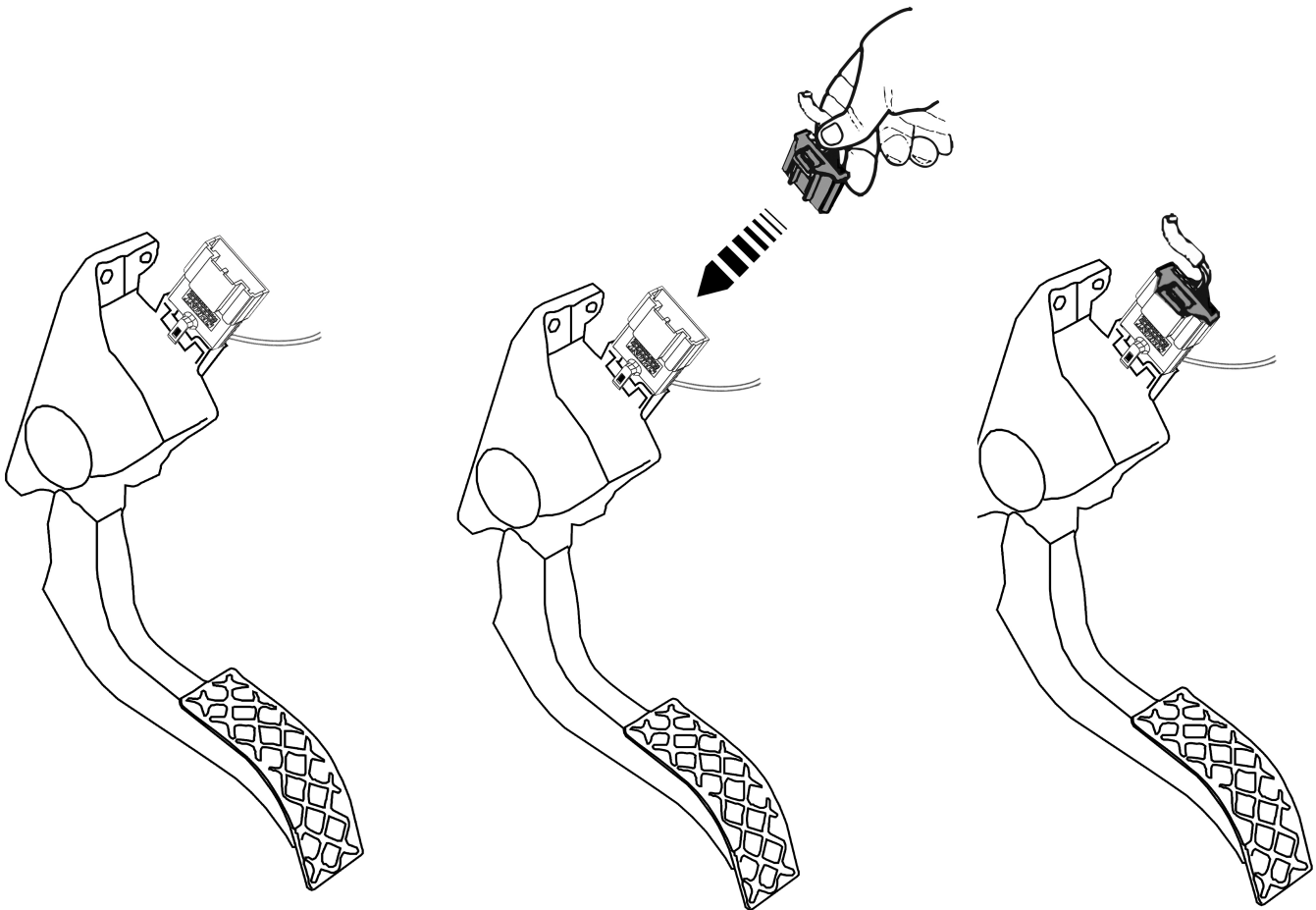

Make sure all connections are firmly in place (both harness connector and Sprint Booster are properly connected).

After you install the device on the pedal, you can attach the selector switch anywhere on the dashboard using the double sided tape (included).

Before attaching the selector switch, clean the selected area of your dashboard with a dry cloth.

Always make sure that the wire does not interfere with your foot or the accelerator pedal. Use the enclosed tie wrap to wrap the spare wire.



In some vehicles it is required to remove the accelerator pedal in order to access the harness connector and install Sprint Booster.



- The installation of Sprint Booster requires special knowledge. We strongly recommend to consult a technician for proper and safe installation.
- Make sure you have read the operation manual carefully before operating the device.

The above are general instructions applying to most vehicles. In some vehicles the installation may vary. Please contact our authorized dealer network for further information.

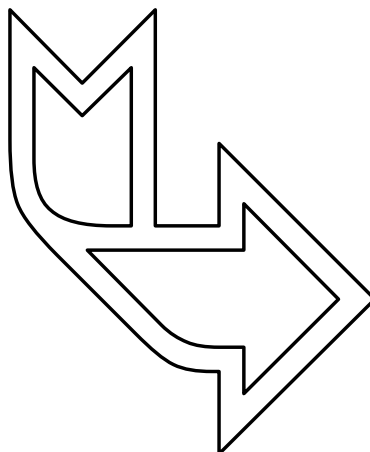

Acceleration modes

Off
(No light)

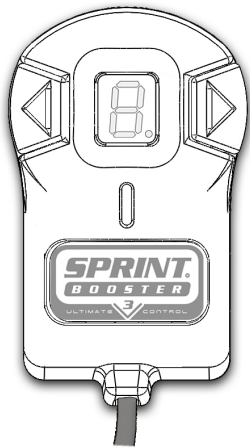

SPORT
(Green light)

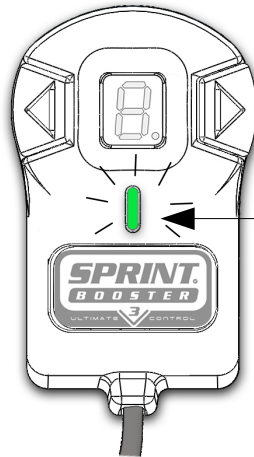

RACE
(Red light)

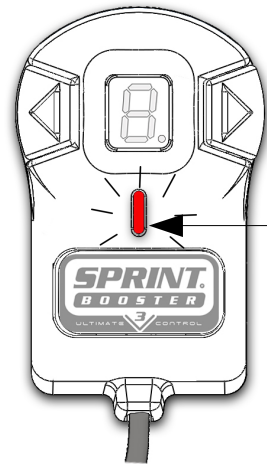

3 Acceleration modes/presets (2 + OFF):

- Off (no light) – Stock response
- SPORT (Green light) – improved response up to 30%
- RACE (Red light) - improved response up to 60%

9

Switching between the Acceleration modes

Press the Main button to cycle through the modes

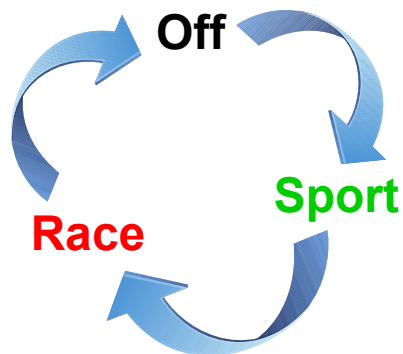
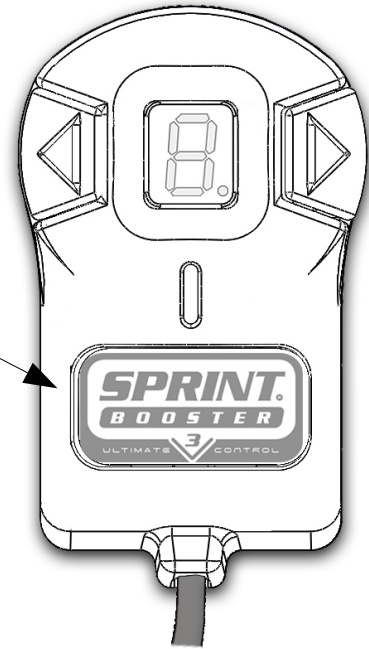

The navigation through different modes should be done when the accelerator pedal is not pressed. Never change modes while pressing the accelerator pedal.

Acceleration Programs

Each mode (**SPORT** – **RACE**) comes with 9 steps-programs:

Select program using the arrow buttons:

1-9 in **SPORT** mode (Green light)

and

1-9 in **RACE** mode (Red light)

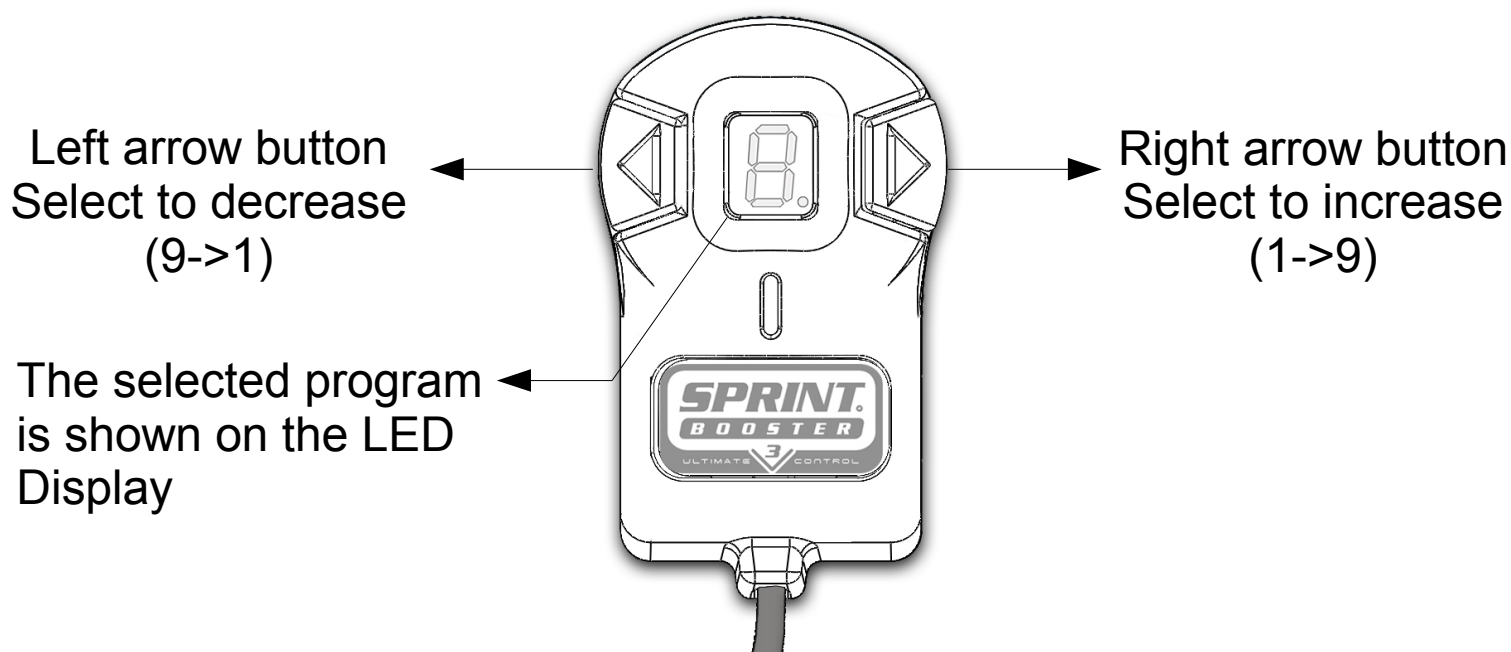

The programs are only available in the **SPORT** and **RACE** mode.

Switch Off LED display

Keep the main button pressed for 3" to switch Off the led display (optional).

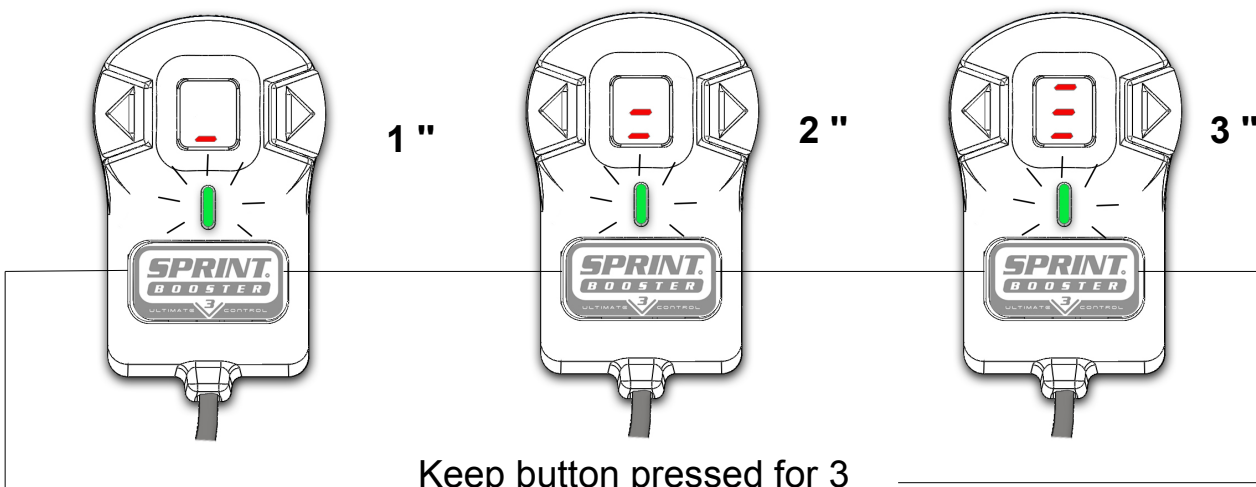

Keep button pressed for 3 seconds to turn Off LED display

Repeat the same procedure to turn the LED Display On.

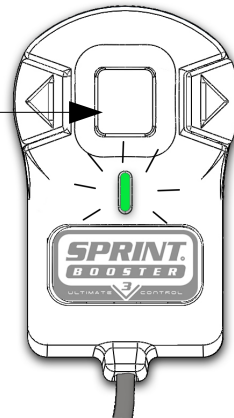

When you turn Off the LED display , the arrow buttons are deactivated and the programs (1-9) cannot be changed. The programs you had selected are stored in the memory. After you switch Off the LED display you will only have the LED light On (SPORT & RACE) that indicates the mode you are in.

This document contains basic information in order to install and start using the product in Acceleration mode. Make sure you have read the user guide before operating the device. The Valet Mode and Pedal lock mode are explained in detail in user guide.

All titles, ownership rights and intellectual property rights in and relating to this brochure or any copies thereof, including but not limited to copyright, logos, names, trademarks, patents, design, text, images, links, concepts and themes are owned by BOULEKOS SA or used under authorized license by BOULEKOS SA. Any reproduction, transmission, publication, performance, broadcast, alteration, license, hyperlink, creation of derivative works or other use in whole or in part in any manner without the prior written consent of BOULEKOS SA is strictly prohibited. Sprint Booster is patent protected (US 8,706,373 ,EP1957310,AU2006323461,CN101341042B,GR1005429,KR10 1372166,ZA200804576,MX2008007365, RU2427481). BOULEKOS SA reserves the right, but has no obligation, to change the Contents at any time. BOULEKOS SA accepts no responsibility, in any manner whatsoever, for damage and/or trouble to your vehicle or product, nor for any accidents that result from misuse of the product. Whilst every effort has been made to ensure the accuracy of the information presented, BOULEKOS SA cannot accept responsibility for errors. 'Sprint Booster' is a trademark of BOULEKOS SA registered in Europe (CTM), USA (®) and other countries.

USER GUIDE



ULTIMATE CONTROL

version



Selector Switch

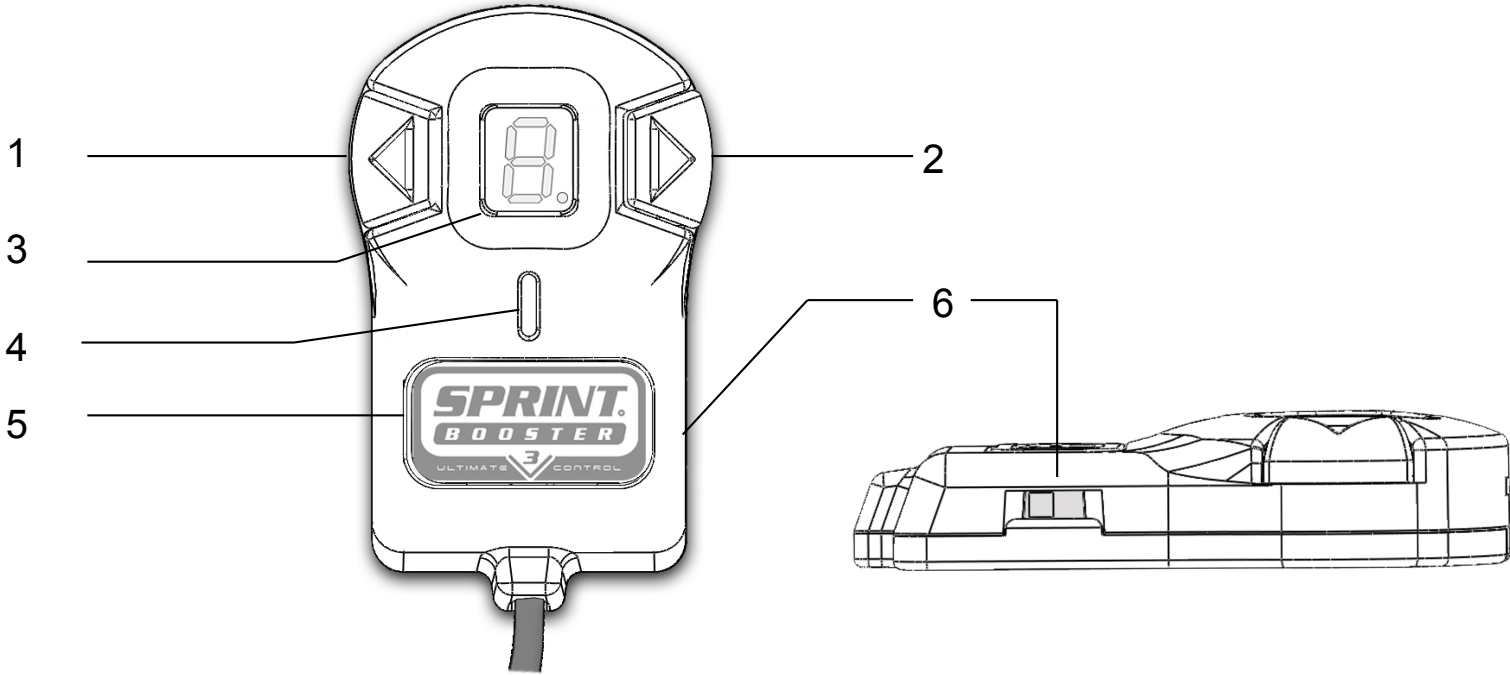

1 & 2

Arrow buttons

- Navigate through the Acceleration programs..... 5-6
- Enter PEDAL LOCK mode / VALET Mode Menu 10-11
- Navigate through the PEDAL LOCK mode / PIN selection..... 12,14
- Navigate through the VALET mode / Level - PIN selection..... 16-18,20

3

7 Segment LED display

- Display of the selected Acceleration program..... 5,7
- PEDAL LOCK mode / VALET Mode Menu display..... 9-11
- PEDAL LOCK mode PIN selection display..... 12-14
- VALET mode Level-PIN selection display 16-18

4

LED indicator

- Indicate the selected Acceleration mode 3

5

Main selection button / Set button

- Acceleration mode -SELECT..... 4
- PEDAL LOCK mode / VALET Mode – SET 11

6

Type of transmission selection..... 2

Choose the type of transmission

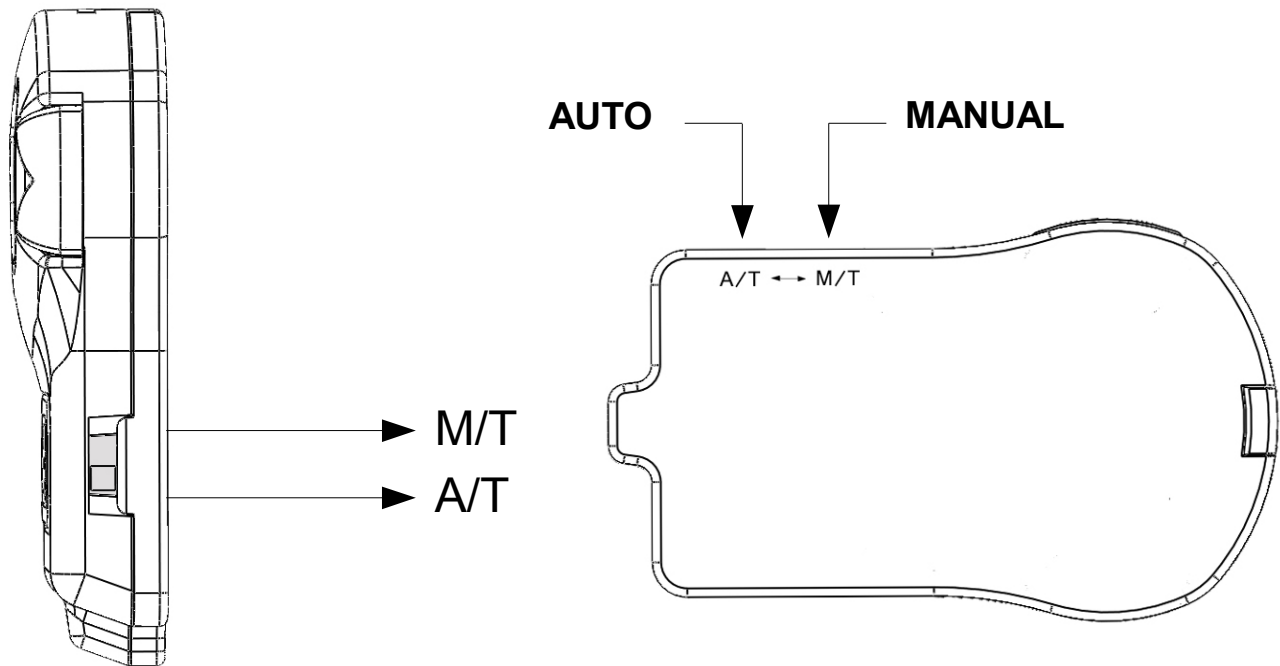

On the right side of the selector , there is a slide switch.

Using a pointed object (pen/pin/paper clip..etc) move the switch to one of the 2 positions depending on the type of your vehicle's transmission.

Move to 'M/T' position for vehicles equipped with manual transmission or to 'A/T' position for vehicles equipped with automatic transmission.

For 'semi-automatic' transmissions (DCT, S tronic, DSG, PDK, SMG, ..etc) move to 'A/T' position



When the slide switch is in the 'M/T' position (manual) a red dot will appear on the LED display indicating the selection of manual transmission once you operate the device.

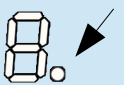

Never change this selection while driving.

Acceleration modes

Sprint Booster comes with 3 Acceleration modes/presets (SPORT / RACE / OFF):

Off mode – Sprint Booster is deactivated. The response of the car has the factory settings. The LED of the Selector switch is OFF.

SPORT mode- Sprint Booster provides improved response up to 30%. The LED of the selector switch in Sport mode is **Green**.

RACE mode – Sprint Booster provides improved response up to 60%. The LED of the selector switch in Race mode is **Red**.

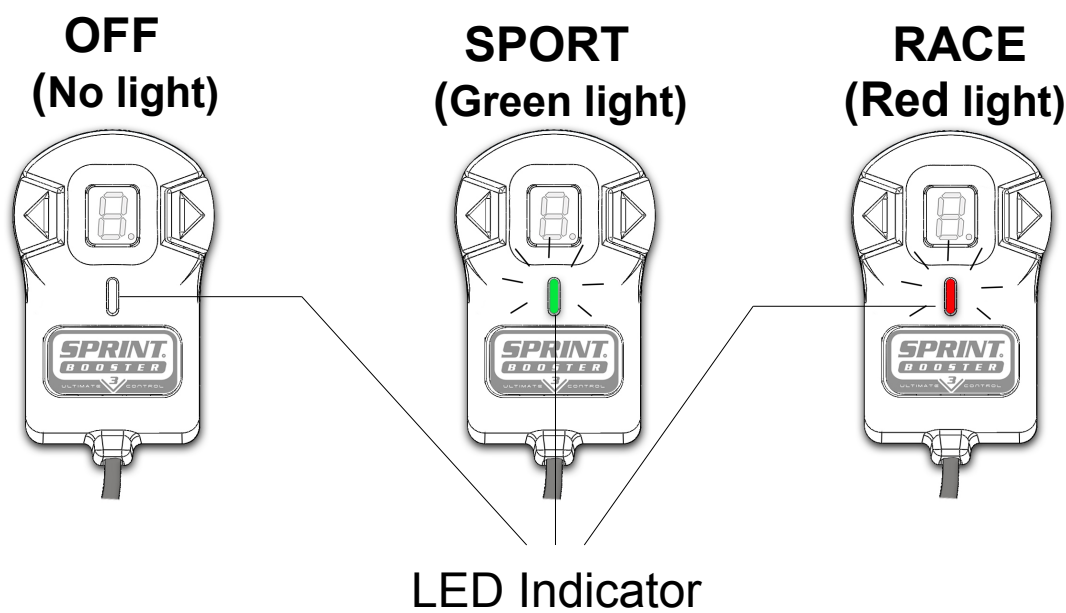

Default settings

Once you start your engine for the first time after you install the Sprint Booster, the device will be in Race mode on program 5 (Acceleration programs 📖 5-6).

Switching between the Acceleration modes

In Order to switch between the different acceleration modes/presets you need to press the main button on the selector Switch (button with Sprint Booster logo).

Main button

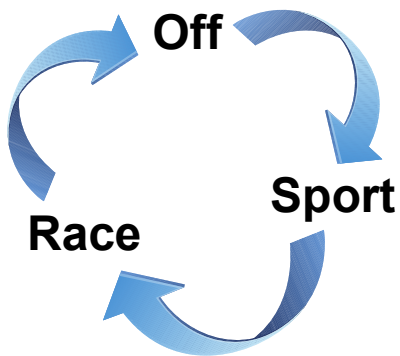
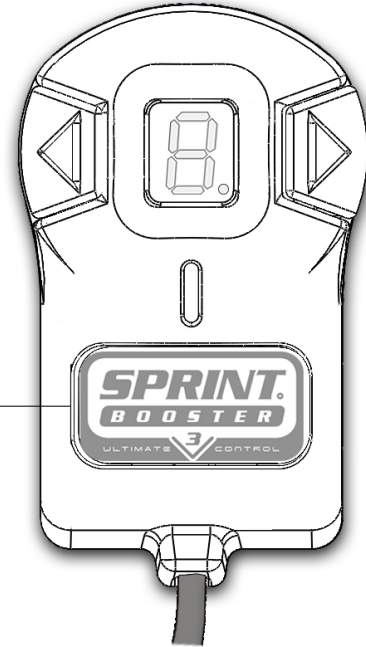

The main button will cycle through the 3 acceleration modes (Off – Sport – Race -Off – Sport ...etc)



The navigation through different modes should be done when the accelerator pedal is not pressed. Never change modes while pressing the accelerator pedal.

Acceleration Programs

Each mode (SPORT – RACE) comes with 9 steps-programs so the driver can choose the one that suits his driving style (18 programs in total).

This allows the driver to fine-tune each mode (SPORT – RACE) according his needs by selecting one of the nine different programs on each mode.

You can select 1-9 in SPORT mode (Green light) and 1-9 in RACE mode (Red light) with '1' being the least aggressive program and '9' the most aggressive one.

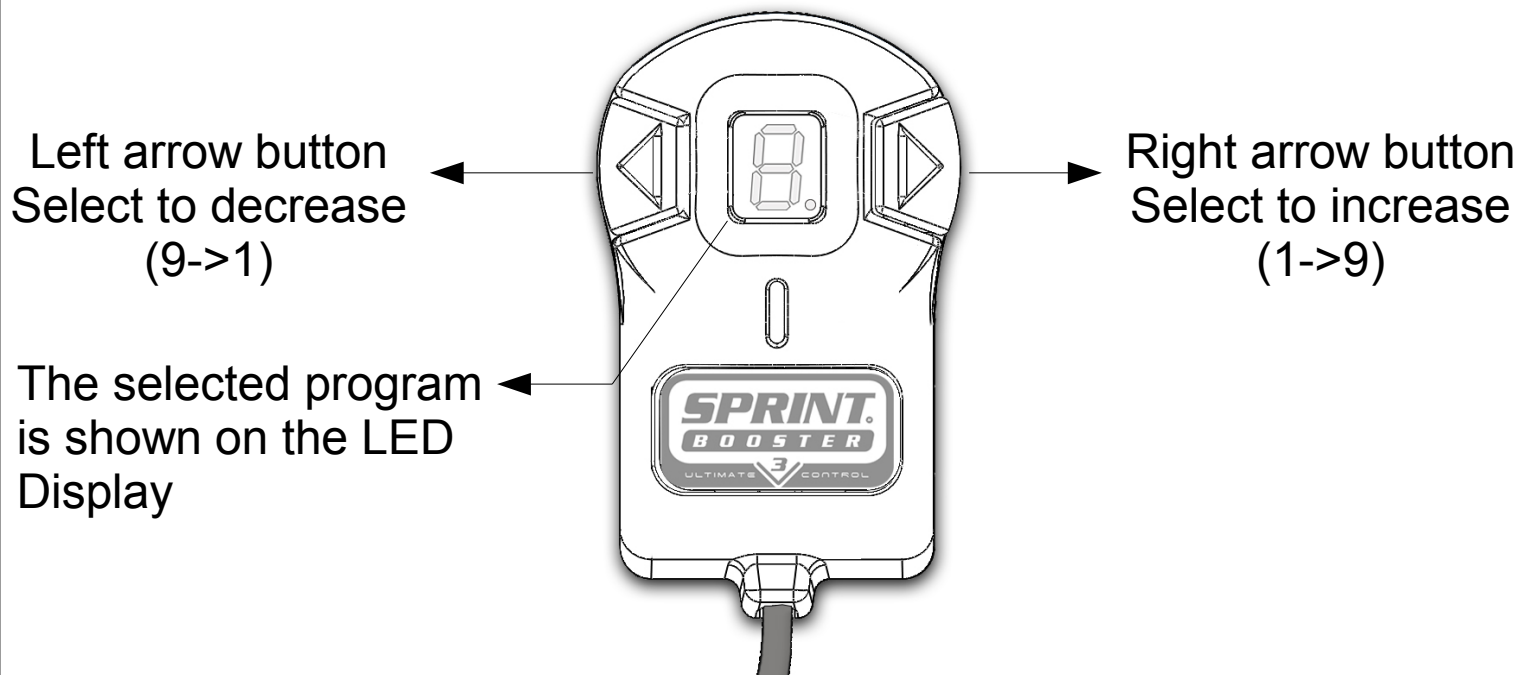

In order to navigate through the different programs-steps on each mode you need to press one of the arrow buttons (left -right) as shown above .

Press left arrow button to decrease (9->1) or right button to increase (1->9).

The selected program is shown on the LED Display.

The programs are only available in the SPORT and RACE mode.

Acceleration Programs

The default programs on the Selector switch are SPORT- 5 & RACE- 5.

With the main selection button move to SPORT or RACE mode and with the arrow buttons select 1-9 to choose acceleration program.

Example : Selecting the program SPORT-9 and RACE-4.

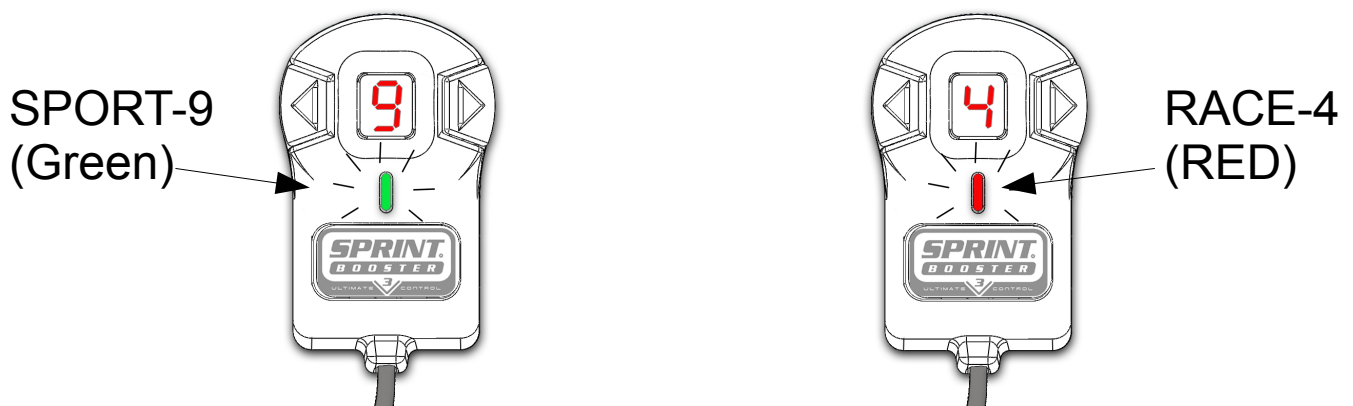

Go to SPORT mode (green light) and press the right arrow until you reach 9. Then press the main button to switch to RACE (red light) and press the left arrow button to go to 4.

The 2 modes now are set as SPORT-9 & RACE-4.

After that , by pressing the main button you will have :

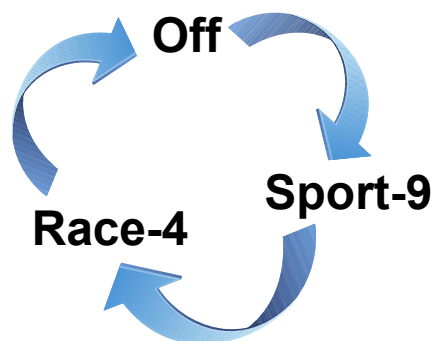

Never change programs while pressing the accelerator pedal.

Switch Off LED display

Anytime, you have the option to switch Off the 7 segment LED display (in SPORT & RACE mode).

To do so , just keep the main selection button pressed for 3 seconds.

During the time you have the button pressed, 3 dashes will appear to indicate 3 seconds. When the third dash appears the LED Display will go Off.

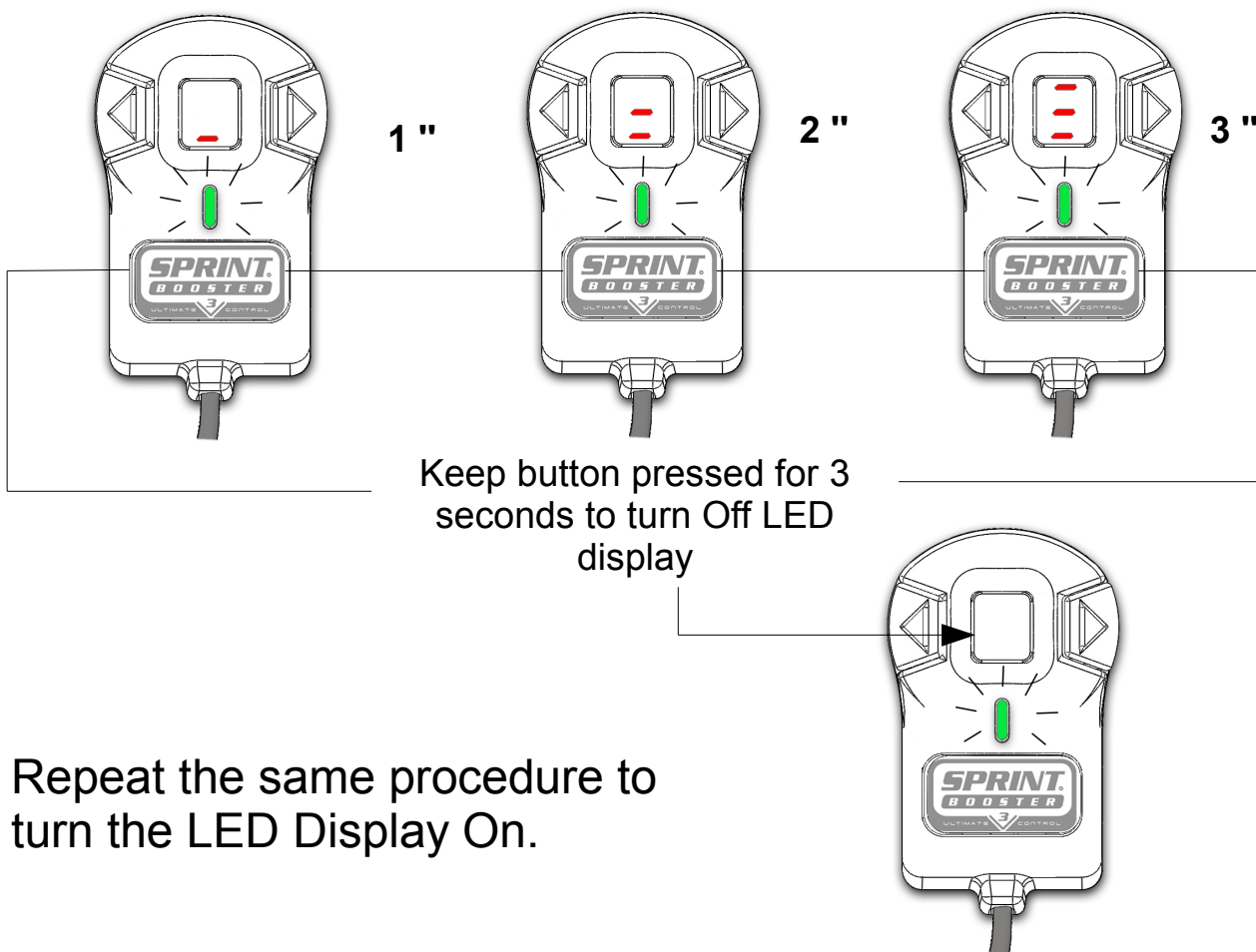

Repeat the same procedure to turn the LED Display On.



When you turn Off the LED display , the arrow buttons are deactivated and the programs (1-9) cannot be changed. The programs you had selected are stored in the memory. After you switch Off the LED display you will only have the LED light On (SPORT & RACE) that indicates the mode you are in.



In case you disconnect the Selector switch from the Sprint Booster, the device will keep the last settings in memory. (e.g if you disconnect the device while you are in SPORT-5 the device will work as SPORT-5).

As soon as you turn off your car's engine the switch (led indicator and led display) will remain active for a few minutes and will go Off as soon as the CAN bus system cuts off the electric power supply. This is a normal procedure and will not drain your battery.

Pedal Lock / Valet mode



The Sprint Booster comes with 2 new important Features :

-Pedal Lock mode → 

-Valet mode → 



Pedal Lock mode

The Pedal Lock mode provides extra protection against unauthorized vehicle use. The driver can deactivate the acceleration ability of the vehicle through a 3 digit PIN.



Valet mode

The Valet mode limits the acceleration of the vehicle by 55 % - 65% - 75% (comes in 3 selectable levels) .It is activated/deactivated through a 3 digit PIN.

The Pedal Lock mode acts as an extra protection against unauthorized vehicle use. In the case of the Sprint Booster being removed from the vehicle, the vehicle will be able to accelerate.

Pedal Lock / Valet mode MENU



In order to activate the Pedal Lock/Valet mode MENU, follow the procedure below:

1. Make sure the car is stationary and the pedal is not pressed.
2. Go to Off mode (LED Off).
3. Press the 2 Arrow buttons simultaneously for 3 seconds.
4. When a dash appears in the LED display, that means you have entered the MENU.

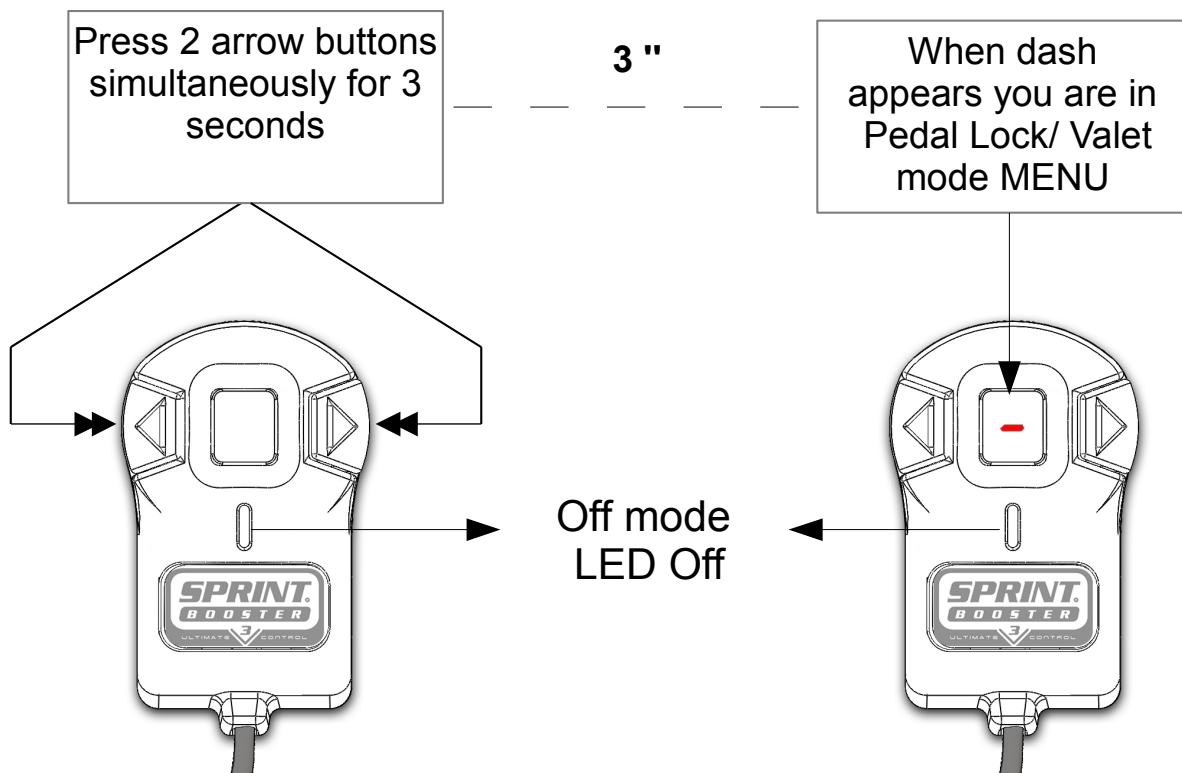



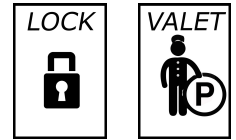

Never enter the Pedal Lock/ Valet mode MENU while driving.

The Pedal Lock/Valet mode MENU should only be accessed when vehicle is parked/stationary.

Pedal Lock / Valet mode MENU



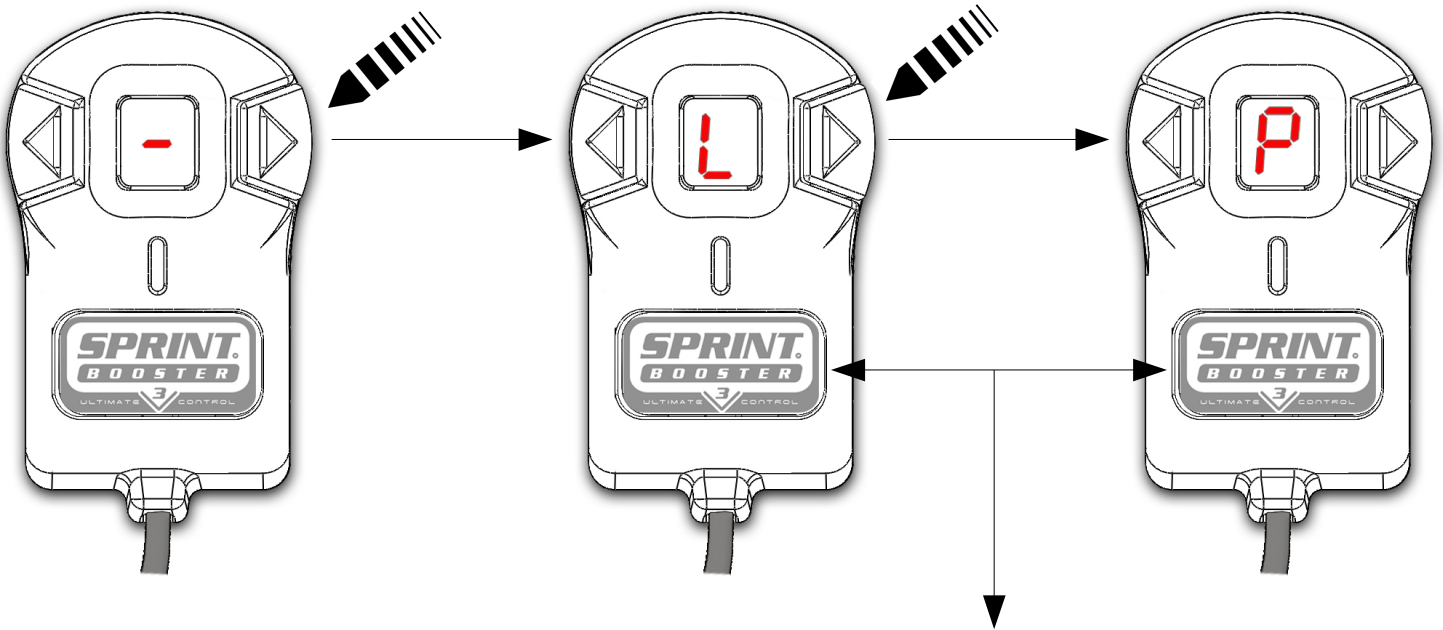

Once you enter the MENU () press the Left or Right arrow button to choose one of the 2 available modes (Pedal lock / Valet mode). By pressing arrow buttons the LED display will cycle between  and .

 → Pedal Lock mode
 → Valet mode



In the Pedal Lock/ Valet mode menu, the main selection button is used for SELECT & SET.

In order to select and enter each mode , press the main selection button when  (for Pedal lock) or  (for Valet mode) appears on the LED display

Pedal Lock mode



In order to activate the Pedal Lock mode you need to press the main selection button when **L** is displayed on the LED display. Once you enter the Pedal lock mode the lower dash on the LED display will start blinking.

This indicates the first digit of the 3 digit PIN code.

Move up or down with the arrow buttons to choose the desired number as the first of the 3 digits of your Pin.

Once you find the number you need press SET (main selection button) to store the 1st digit of your PIN.

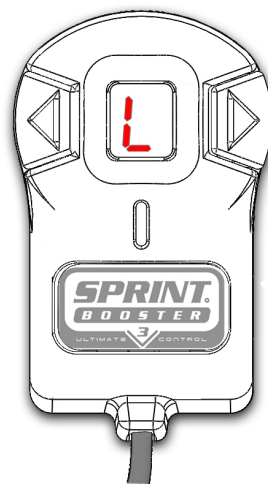



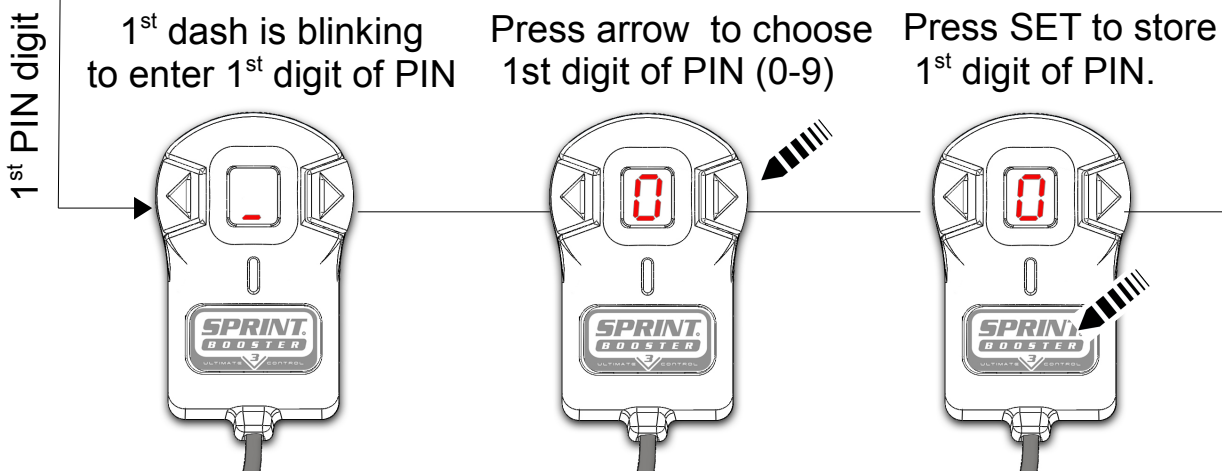

SELECT/ SET
button



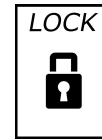

The 1st digit of your PIN is now stored. Repeat the same procedure to store the 2nd and 3rd digit of your PIN. In second digit the blinking dash will be the middle one and on the third digit , the upper one.

Pedal Lock mode



As soon as you store the third digit of your pin the  will blink on the LED display for 10 seconds. After this time the  will stop blinking and will remain ON. During the time the  is blinking you have the option to cancel the lock by pressing any of the 3 buttons on the Selector switch. If you press any button during the time it's blinking, the lock will be canceled and the LED display will exit the MENU.

Once the  stops blinking, the acceleration can only be enabled with the 3 digit PIN ( 14).

 While navigating through the MENU if none of the buttons are pressed within 10" the device will cancel the procedure and EXIT the MENU.

Don't press the pedal while activating the Pedal Lock mode. If the accelerator pedal is pressed while entering the PIN, the device will cancel the procedure and EXIT the MENU.



Never enter the Pedal Lock mode MENU while driving.

Pedal Lock mode should only be accessed when vehicle is parked/stationary.

Deactivate Pedal Lock

UNLOCK



In order to deactivate the Pedal Lock :

Press the 2 Arrow buttons simultaneously for 3 seconds.

Press 2 arrow buttons
simultaneously for 3
seconds

3 "

The lower dash
will start blinking
to enter PIN.

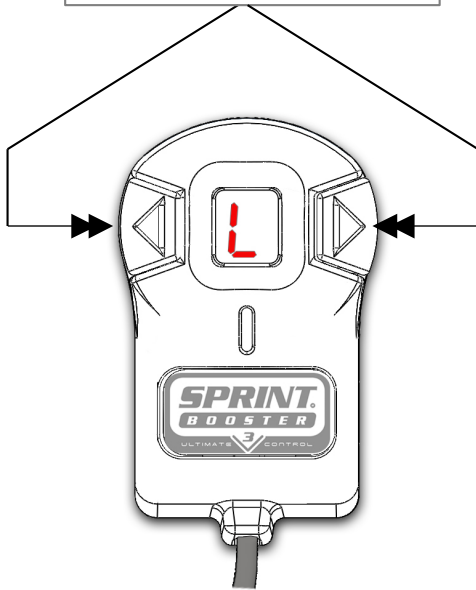
1st PIN digit

1st dash is blinking
to enter 1st digit of PIN

Press arrow to choose
1st digit of PIN (0-9)

Press SET to store
1st digit of PIN.

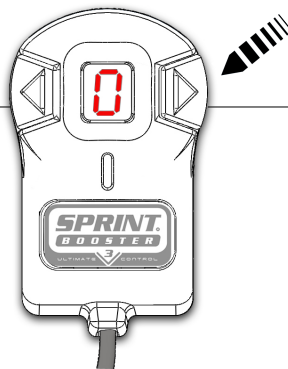

The 1st digit of your PIN is now stored. Repeat the same procedure to store the 2nd and 3rd digit of your PIN. After you enter successfully the 3rd digit of your pin, the Pedal lock mode will be deactivated and  will blink twice . Then the device will exit the MENU and will go back to Off mode.

In case you enter a wrong PIN the 1st dash will start blinking to enter The PIN again.



Once you enable the Pedal Lock mode the car will not be able to accelerate when you press the accelerator pedal and will stay on idle.

PIN



The PIN should be entered every time you need to activate-deactivate the Pedal Lock mode. You have the option to use different PIN Every time (not recommended). The 3 digit PIN you use to activate the Pedal Lock mode is the one you need to use to deactivate it every time.

Make sure you have memorized the PIN before activating the Pedal Lock mode.

PIN reset

In case you forgot your PIN, you need to follow the procedure to reset the PIN stored.

Sprint Booster has a PIN reset option through a time delay process:

1. Turn On the engine to activate the power on the device.
2. When the device is in Lock mode there will be an  on the LED Display.
3. Wait for 35 minutes (with power On) without pressing the pedal.
4. After the time delay limit (35') the device will reset the password, the digit  will blink for a few seconds on the LED display and Pedal Lock mode will be deactivated (Will go back to Off mode).



-During the 35' reset process the pedal should not be pressed.If the pedal is pressed during this time , the time delay limit will be renewed to another 35'.

-Always make sure you have memorized the PIN before activating the Pedal Lock mode in order to avoid the time delay process to reset the PIN. In case you have forgot your PIN and have no time to follow this procedure , you will need to completely uninstall the device from the Pedal.



In case you activate the Pedal Lock mode and disconnect the selector switch from the device, the 35' reset option does not apply. In order to be able to reset the PIN you need to have the selector switch connected to the device.

Valet mode



Valet mode limits the acceleration of the vehicle by 55 % - 65% - 75% (comes in 3 selectable levels) .It is activated/deactivated through a 3 digit PIN.

By limiting the acceleration there will be a significant reduce in vehicle's performance (Power and Torque).

In order to activate the Valet mode you need to follow the procedure Below:

-Press the main selection button when  is displayed on the screen. After that , the number '1' will appear on the screen.This indicates the first of the 3 Valet mode levels.

-You will now need to choose the desired level.With the arrow buttons you can navigate through the 3 different levels :

Level 1. The acceleration is limited by 55%

Level 2. The acceleration is limited by 65%

Level 3. The acceleration is limited by 75%

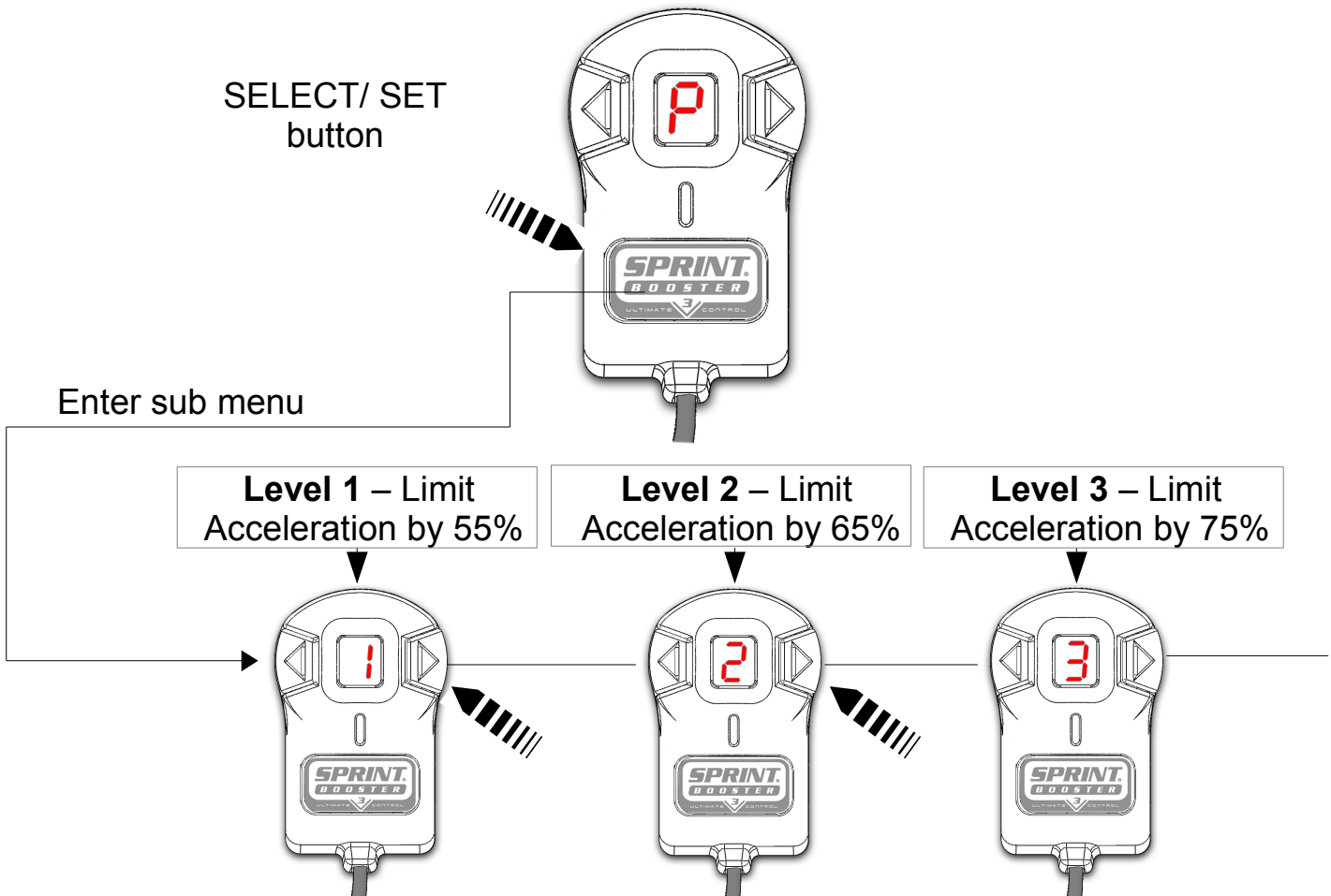

Valet mode



In order to select the Valet mode level press the main selection button when the desired level is displayed on the LED display .

For example , in order to choose the 2nd level of Valet mode (limit acceleration by 65%) , choose the number 2 with the arrow buttons and press the main selection button to select.

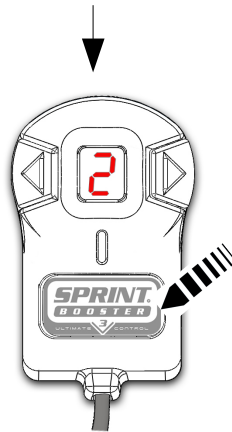

Once you have selected the desired Valet mode level, you will be requested to enter your PIN in order to Store the Valet mode.

1st PIN digit

1st dash is blinking
to enter 1st digit of PIN

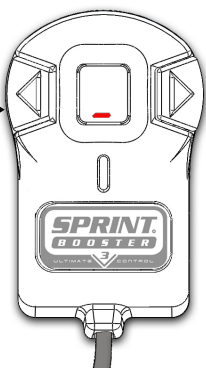

Press arrow to choose
1st digit of PIN (0-9)

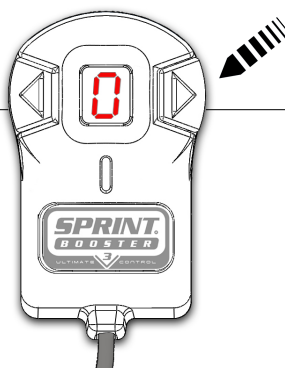

Press SET to store
1st digit of PIN.



Valet mode



The 1st digit of your PIN is now stored. Repeat the same procedure to store the 2nd and 3rd digit of your PIN. In second digit the blinking dash will be the middle one and on the third digit, the upper one.

As soon as you store the third digit of your pin the  will blink once and then will remain on the display.

The Valet mode is now stored. The vehicle will run with limited acceleration.

After you have set the Valet mode On you can see which level has been selected by pressing the main selection Button. As soon as you press the button the number of the selected level will appear on the Led display.

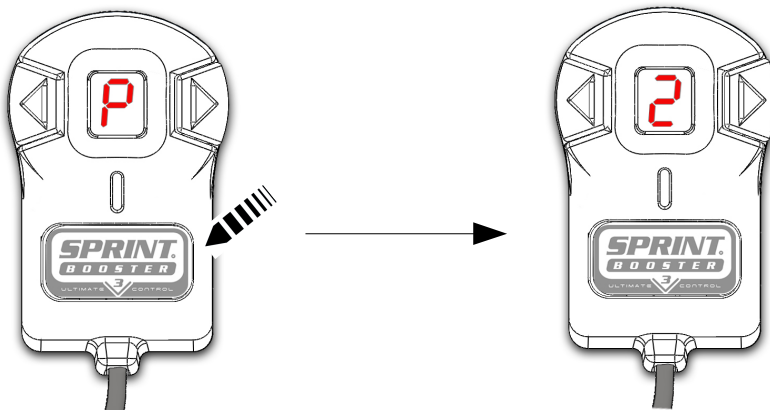

Valet mode



On vehicles with low hp use only the 1st level as in 2nd and 3rd level the acceleration will dramatically decrease. Use the 3rd level only in vehicles with high hp (300+) :

Vehicle's HP	suitable levels
Up to 150 hp	1
150-300	1,2
300 and up	1,2,3

We suggest testing the levels in an open area without traffic so you can choose the right one for your vehicle depending the power/torque of your vehicle as well as the limit you need to set (according the above chart) .



- When you activate Valet mode, you should always inform the person who is driving the vehicle that the car has Valet mode enabled and the acceleration is reduced.
- For steep roads or steep parking garages use only the 1st level of valet mode .
- Do not enable the Valet mode when driving on Highways.



- The pin reset options in Pedal lock mode through time delay process apply to Valet mode as well ( 15).
- When Valet mode is activated , Pedal lock mode cannot be enabled.

Valet mode



Deactivate Valet mode

In order to deactivate the Valet mode :

Press the 2 Arrow buttons simultaneously for 3 seconds.

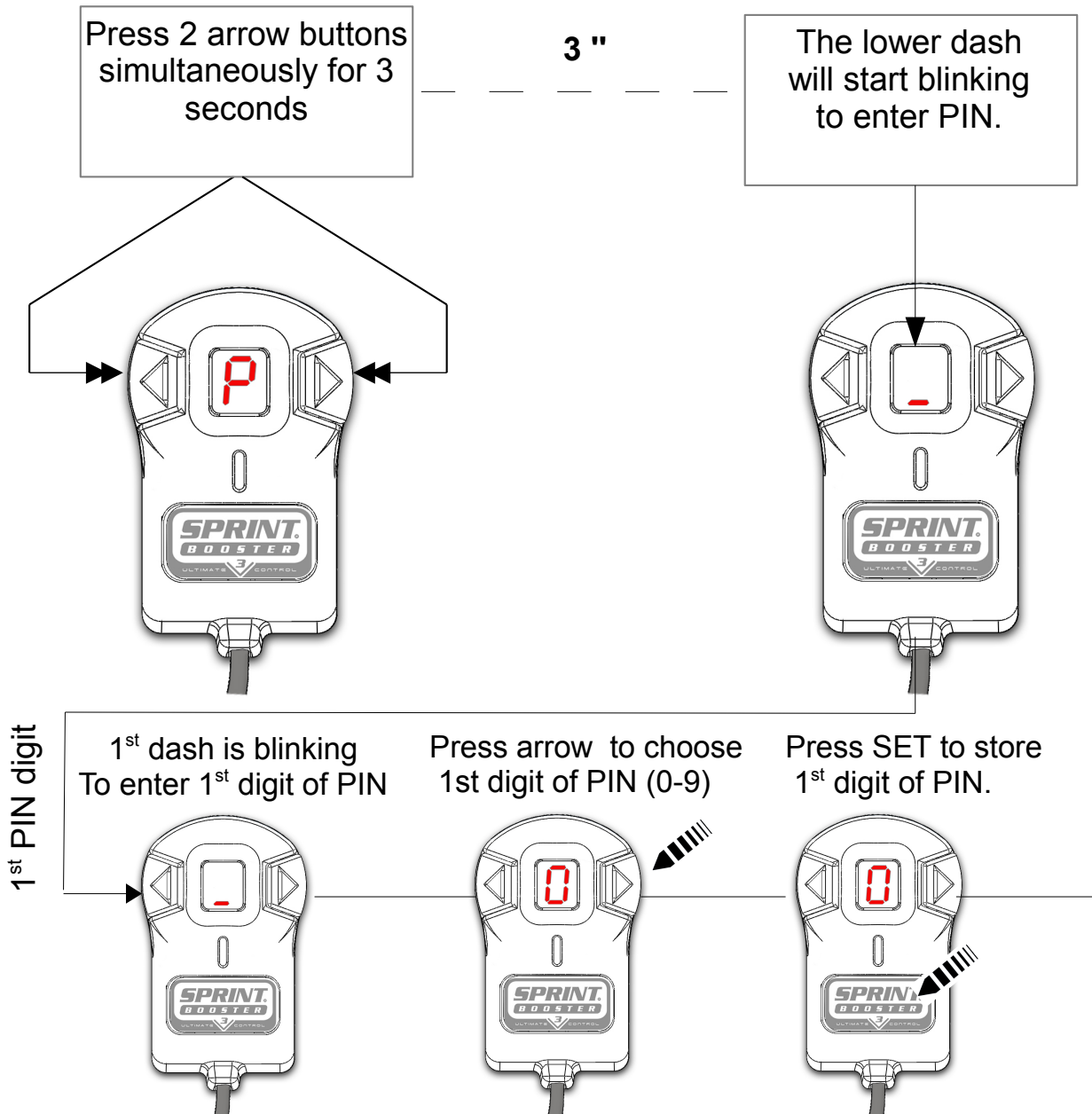

The 1st digit of your PIN is now stored. Repeat the same procedure to store the 2nd and 3rd digit of your PIN. After you enter successfully the 3rd digit of your pin the Valet mode will be deactivated and will blink twice . Then the device will exit the MENU and will go back to Off mode. In case you enter a wrong PIN the 1st dash will start blinking to enter the PIN again.

Troubleshooting

SYMPTOMS	POSSIBLE CAUSE	SUGGESTED ACTION
 <p>Check engine light appears right after installation.</p>	<p>1. Device installed while Can bus system was active.</p>	<p>1a. Switch On – Off the engine several times (If the check engine light is still On go to step 1b). 1b. Remove the device, reset the check engine light (📖 22 'Reset check engine light') and reinstall waiting for 15 minutes with the engine Off and the keys removed before install the device.</p>
	<p>2. Device has not been connected properly.</p>	<p>2. Repeat the installation procedure making sure that all connections are firmly in place.</p>
	<p>3. Non compatible device.</p>	<p>3. Contact a Sprint Booster dealer in order to get the correct device for your vehicle.</p>
<p>Selector Switch does not light up.</p>	<p>The selector switch has not been connected properly.</p>	<p>Remove and re-install the Selector switch. Never pull the connectors from the wires</p>

Troubleshooting



In case the vehicle's check engine light goes On you can follow the steps below to reset the light:

1. Switch On and Off your car's engine several times. Most vehicles will reset any sporadic error during this process.
2. Consult a technician or your local dealer so the error can be erased through a diagnostic tool.