

**advanced FLOW engineering**

**Instruction Manual** P/N: 51-76006 / 54-76006 / 75-76006

Make: **Toyota** Model: **Land Cruiser (LC200/J200)** Year: **2008-2017** Engine: **V8-5.7L**

Make: **Lexus** Model: **LX 570** Year: **2012-2017** Engine: **V8-5.7L**



- Please read the entire instruction manual before proceeding.
- Ensure all components listed are present.
- If you are missing any of the components, call technical support.
- Ensure you have all necessary tools before proceeding.
- Do not attempt to work on your vehicle when the engine is hot.
- Disconnect both the negative battery terminal before proceeding.

## Retain factory parts for future use.

Label	Qty.	Description	Part Number
A1	1	Pro DRY S (Gray Media)	21-91092
A2	1	Pro 5R (Blue Media)	24-91092
A3	1	Pro-GUARD 7 (Gold Media)	72-91092
B	1	Tube	05-76006B1
C	1	Housing	05-76006B2
D	1	Plug, Urethane	05-01202
E	1	Coupling, Silicone Hump	05-01398
F	1	Clamp, T-bolt	03-50265
G	1	Seal Trim (26" inches)	05-00007
H	1	Clamp #052	03-50008
I	2	Screw, Torx: M4	03-50491
J	1	Fitting, Nipple, Brs Hose	03-50191

Installation will require the following tools:

10mm & 8mm nut drivers, pliers, T20 & T30 drivers, 10mm & 11mm deep socket & driver, flathead screwdriver, phillips screwdriver and 7/16" wrench.

**Note:** Not legal for use in California. The use of this device in any on-road or off-road vehicles registered with the California Dept of Motor Vehicles (DMV) is strictly prohibited.

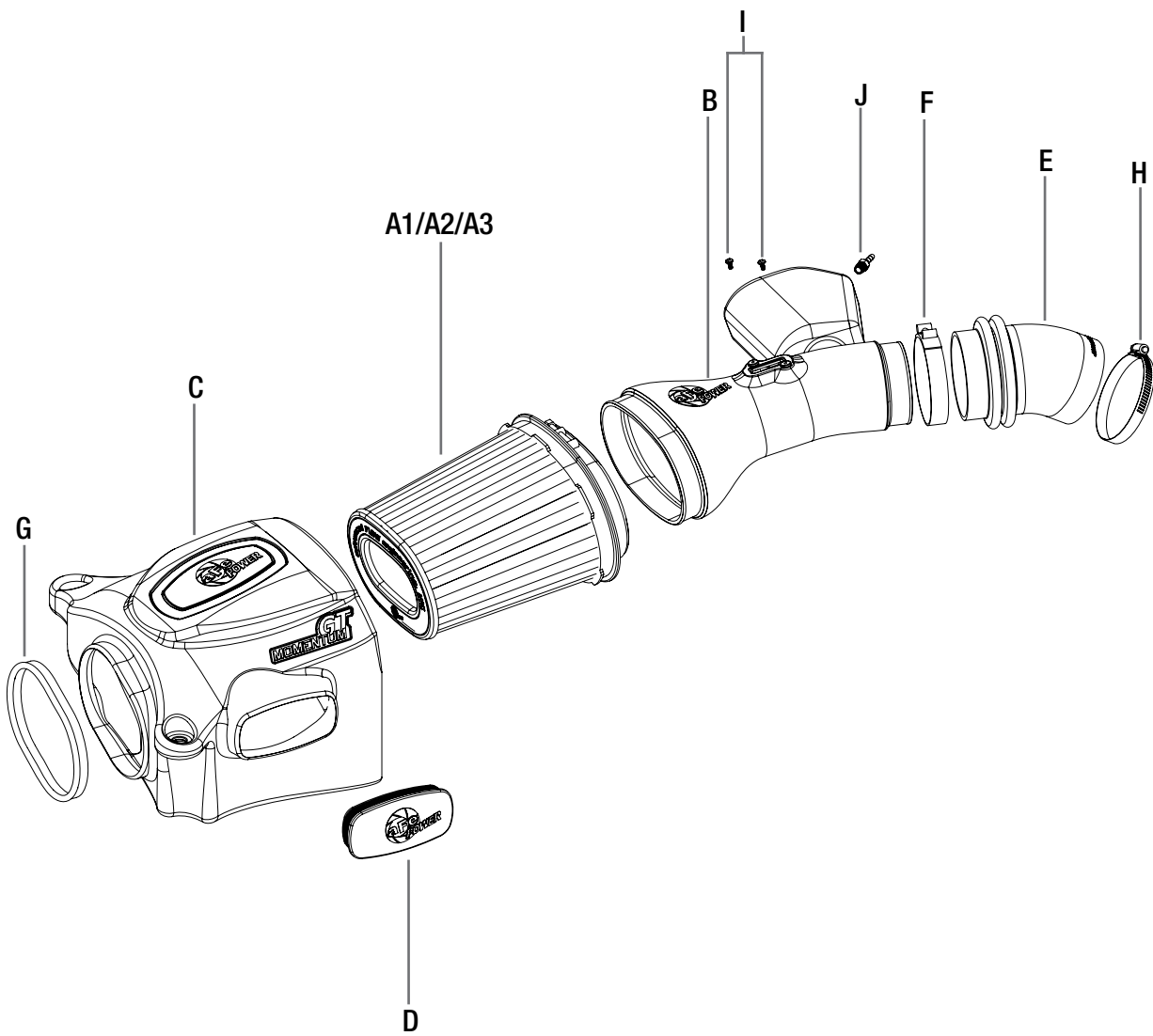



**Refer to Figure A for Step 1**

Step 1: **Lexus Only:** Remove the 7 clips (1) holding down the side cover (2) by pushing down on the center of the clip to disengage them. Remove the side cover (2).



Figure B

**Refer to Figure B for Step 2**

Step 2: Disconnect the MAF sensor (3). Using a flat blade screwdriver, unclip the wire loom (4) from the air box.

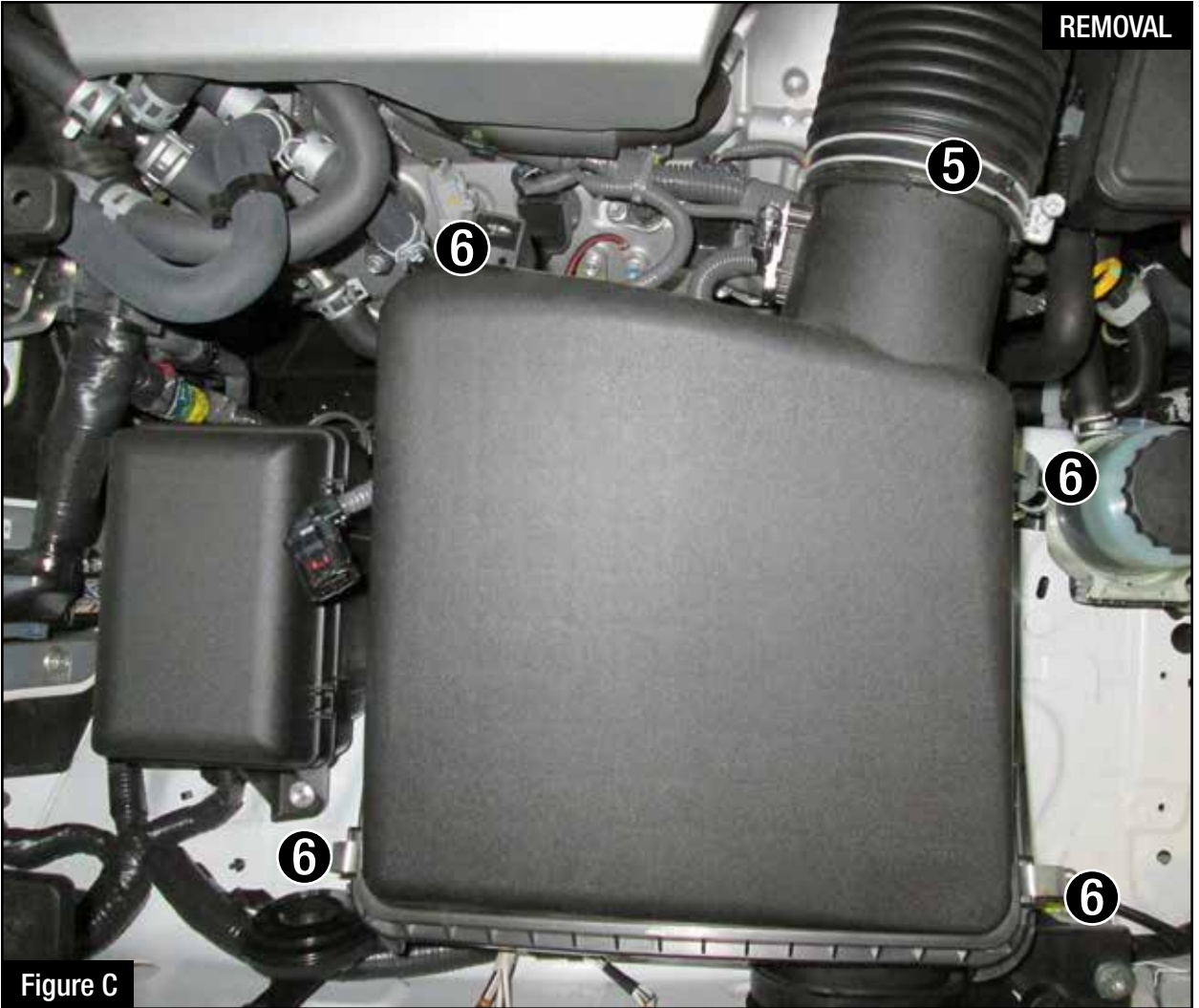
**Figure C****Refer to Figure C for Step 3**

Step 3: Using a 10mm nut driver, loosen the clamp (5) at the air box. Unsnap the 4 clips (6) holding down the air box lid. Remove the lid and the air filter.





Figure D

**Refer to Figure D for Step 4**

Step 4: Using a 10mm nut driver, remove the 3 screws (7) holding the lower section of the air box.  
Remove the air box.



**Refer to Figure E for Step 5**

Step 5: Using a 10mm nut driver, remove the 2 screws (8) and the air inlet (9).



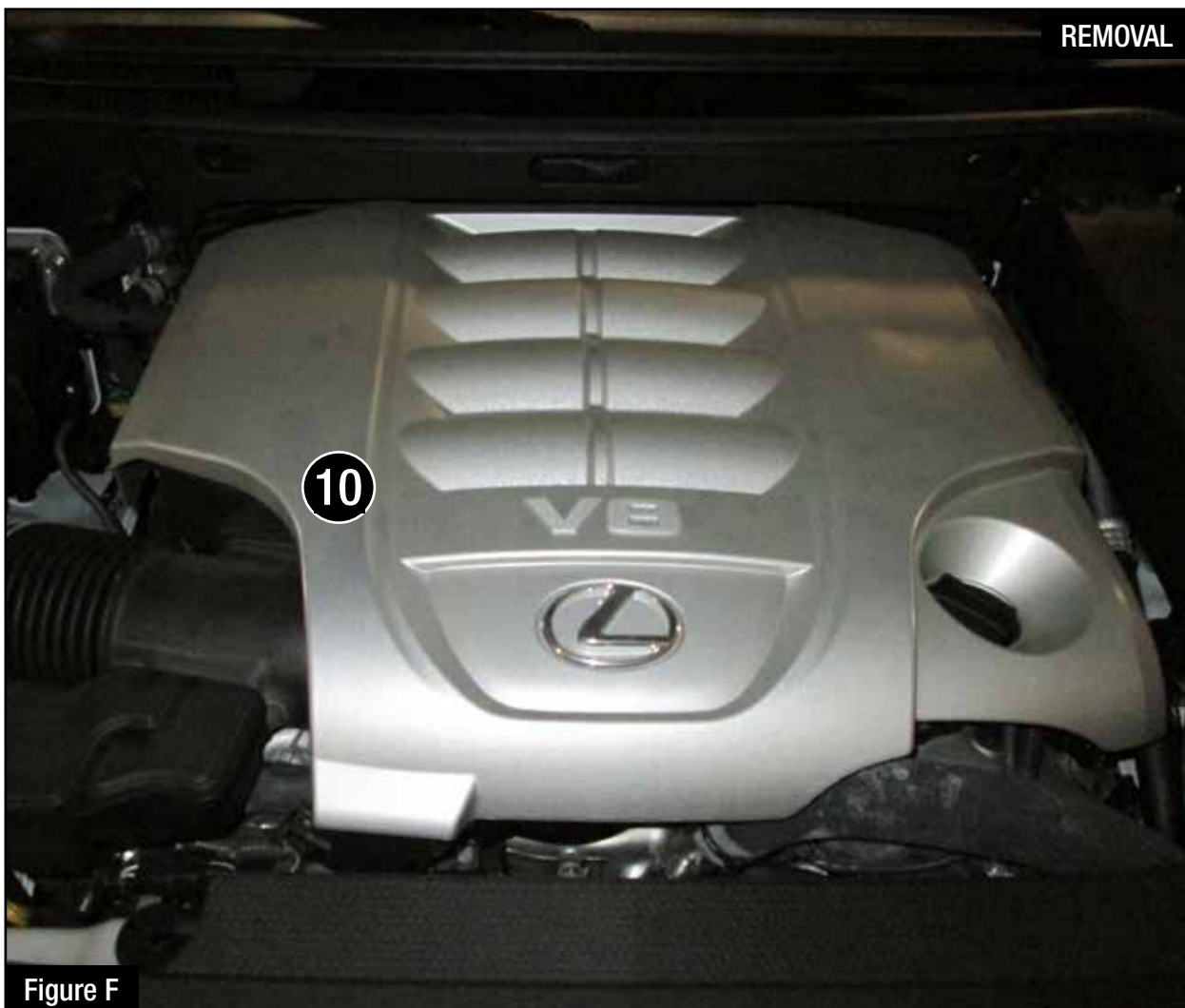

Figure F

**Refer to Figure F for Step 6**

Step 6: Remove the engine cover (10) by pulling up and then out. Set the engine cover aside.

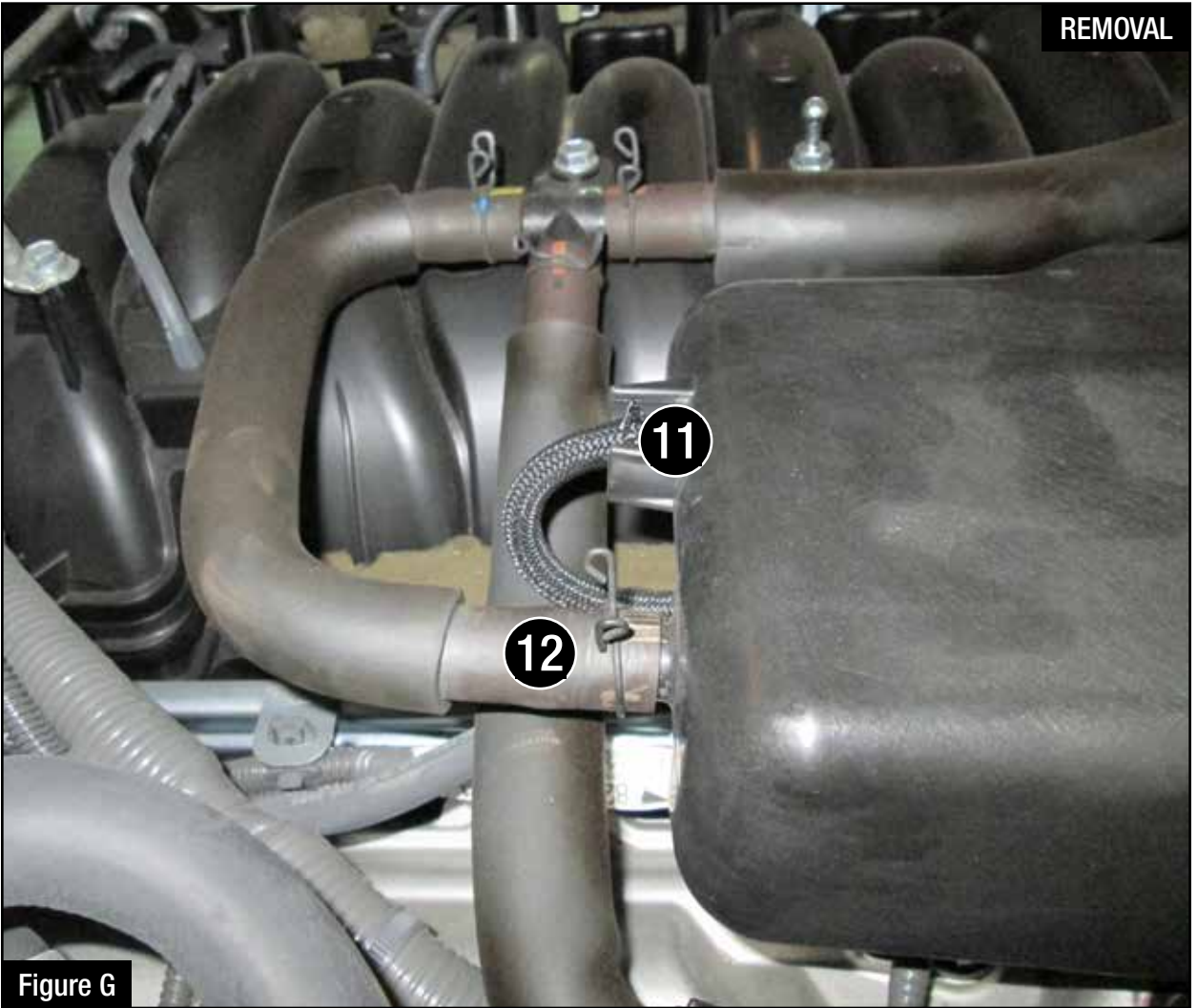

Figure G

**Refer to Figure G for Step 7**

Step 7: Remove the vacuum hose (11) and breather hose (12) from the intake tube.



Figure H

**Refer to Figure H for Step 8**

Step 8: Using a 10mm nut driver, loosen the clamp (13) at the throttle body and remove the intake tube.



### Refer to Figure I for Step 9

Step 9: Remove the 3 screws with metal inserts and bushing (14) from lower section of the air box and install them into the aFe intake housing.



Figure J

**Refer to Figure J for Step 10**

Step 10: Install the trim seal (15) on the inlet opening of the aFe housing.



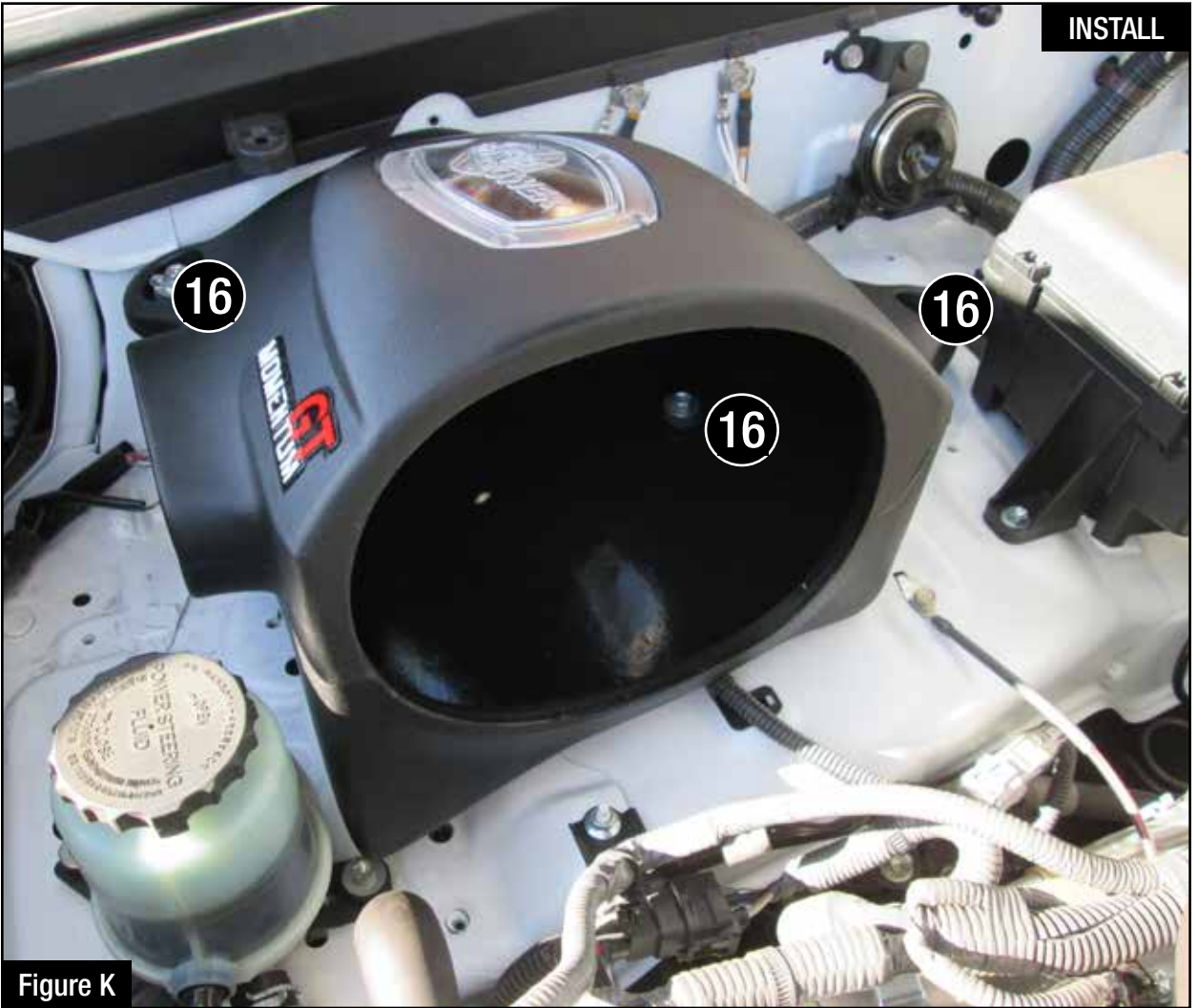

Figure K

**Refer to Figure K for Step 11**

Step 11: Install the aFe housing into the vehicle. Tighten the three mounting screws (16) with a 10mm socket and driver.





Figure L

**Refer to Figure L for Step 12**

Step 12: Slide the aFe filter and clamp into the aFe housing and push it in until it locks into place. Do not tighten clamp at this time.



Figure M

**Refer to Figure M for Step 13**

Step 13: Using a Phillips screw driver, remove the mass air flow sensor ⑰ from the upper half of the air box and install it on the aFe intake tube using the two supplied M4 screws and a Torx 20 driver.

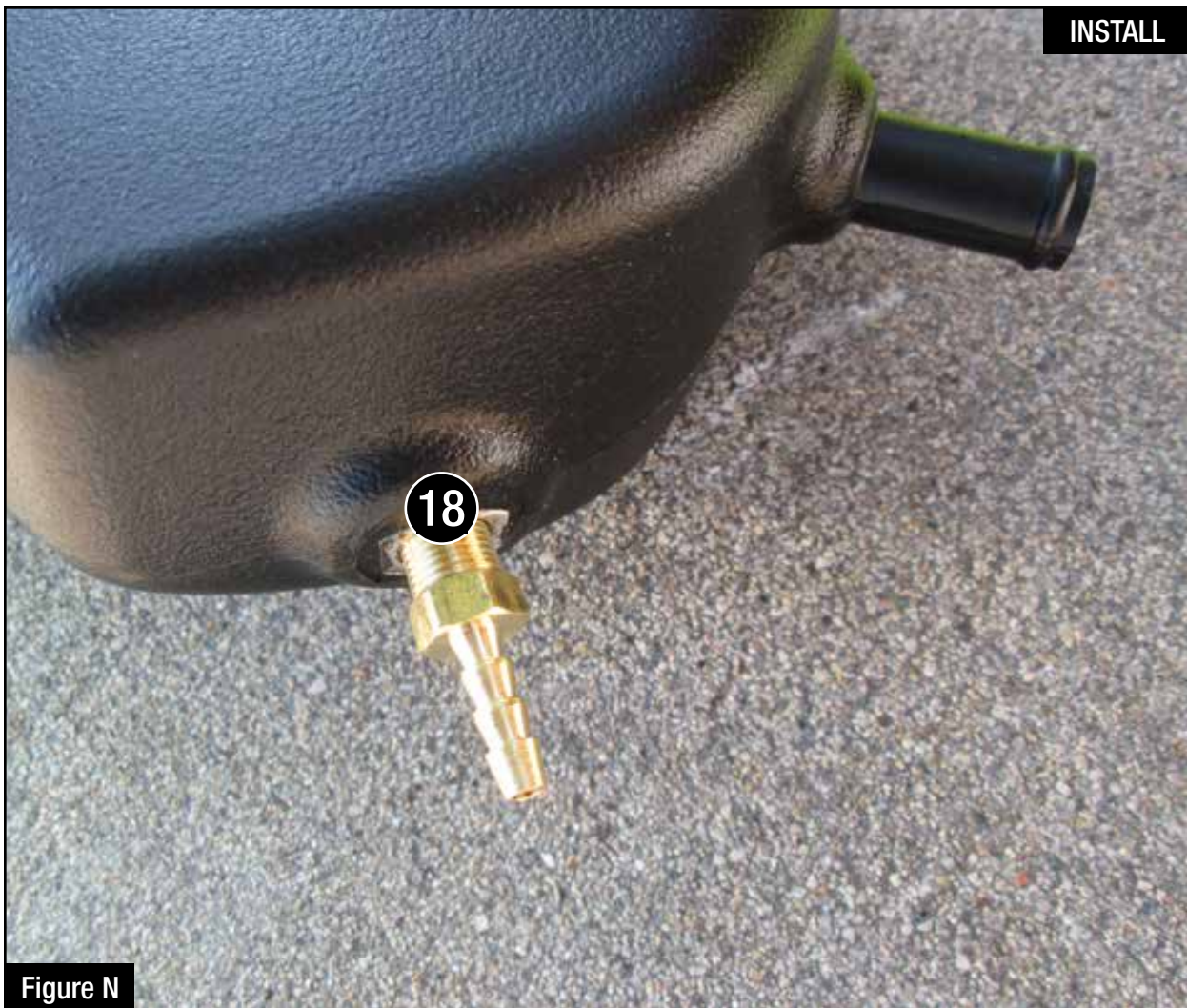

Figure N

**Refer to Figure N for Step 14**

Step 14: Using a 7/16" wrench, install the supplied brass fitting (18) into the aFe intake tube.



**Figure 0****Refer to Figure 0 for Step 15**

Step 15: Install the supplied silicone coupler (19) and clamp (20) onto the throttle body, snug but do not tighten the clamp. Place the T-bolt clamp (21) on the coupler, do not tighten at this time.



**Refer to Figure P for Step 16**

Step 16: Install the aFe intake tube into the coupler first and then into the filter. Tighten all the clamps.

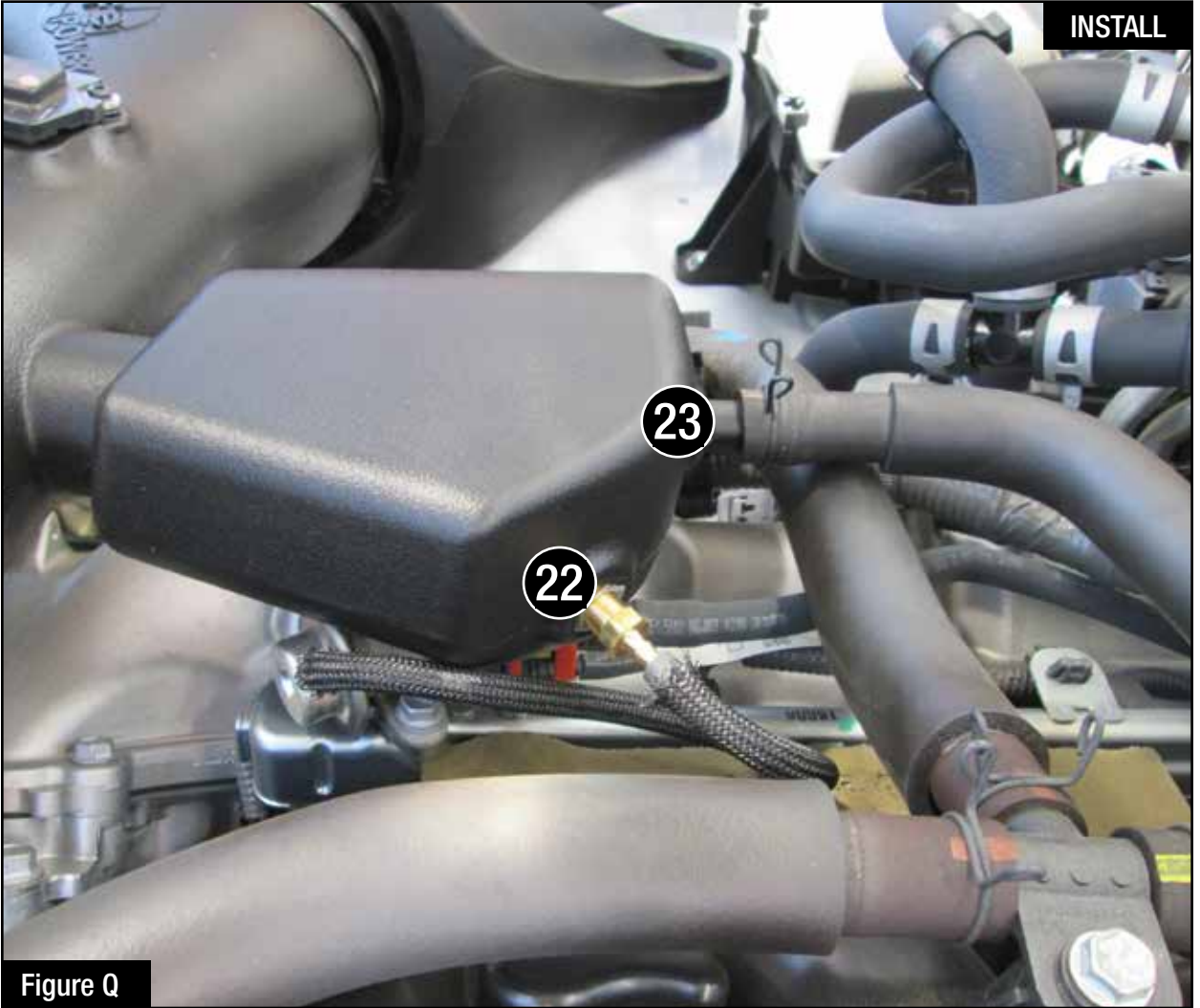

Figure Q

**Refer to Figure Q for Step 17**

Step 17: Connect the vacuum hose (22) and the breather hose (23).



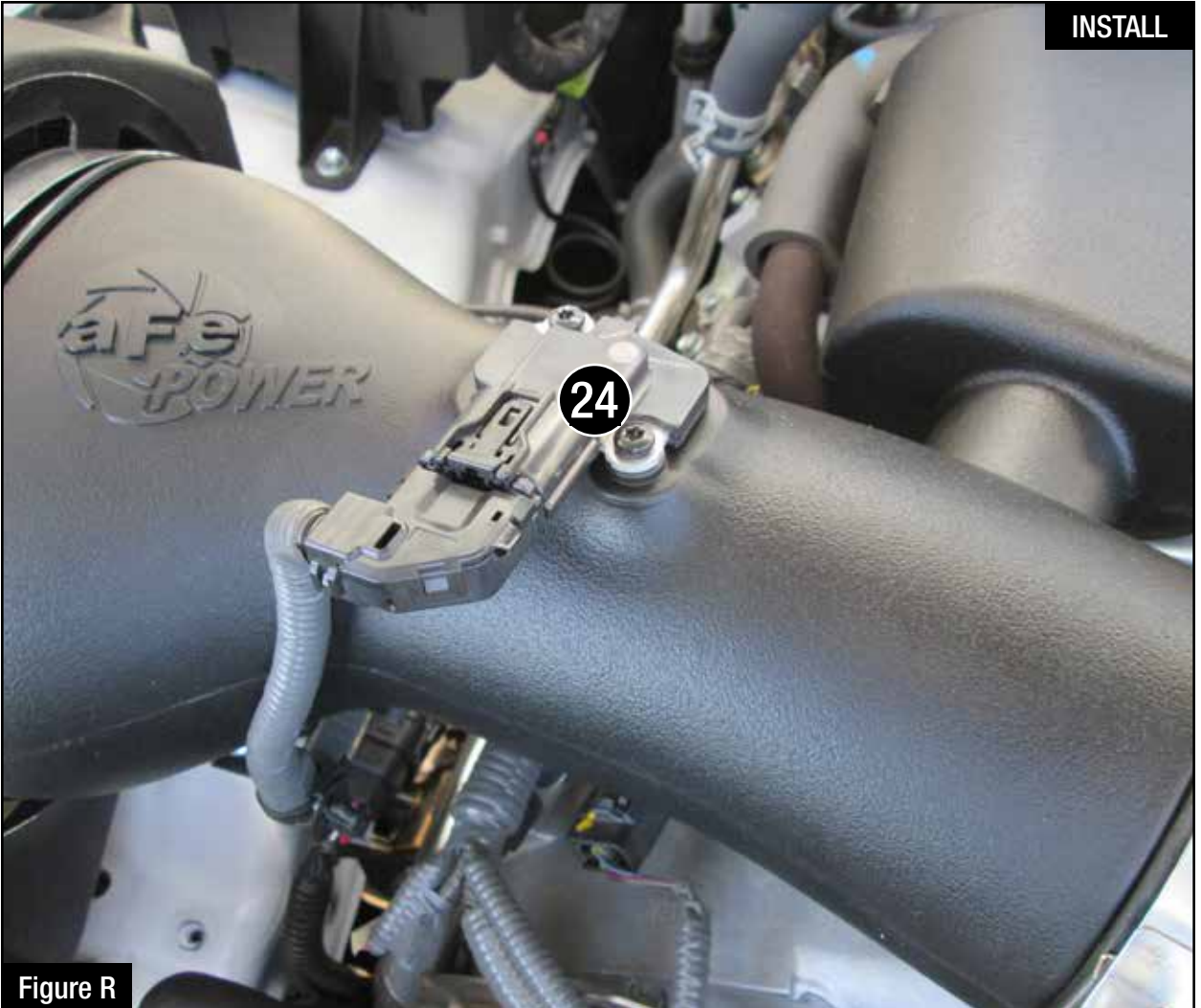
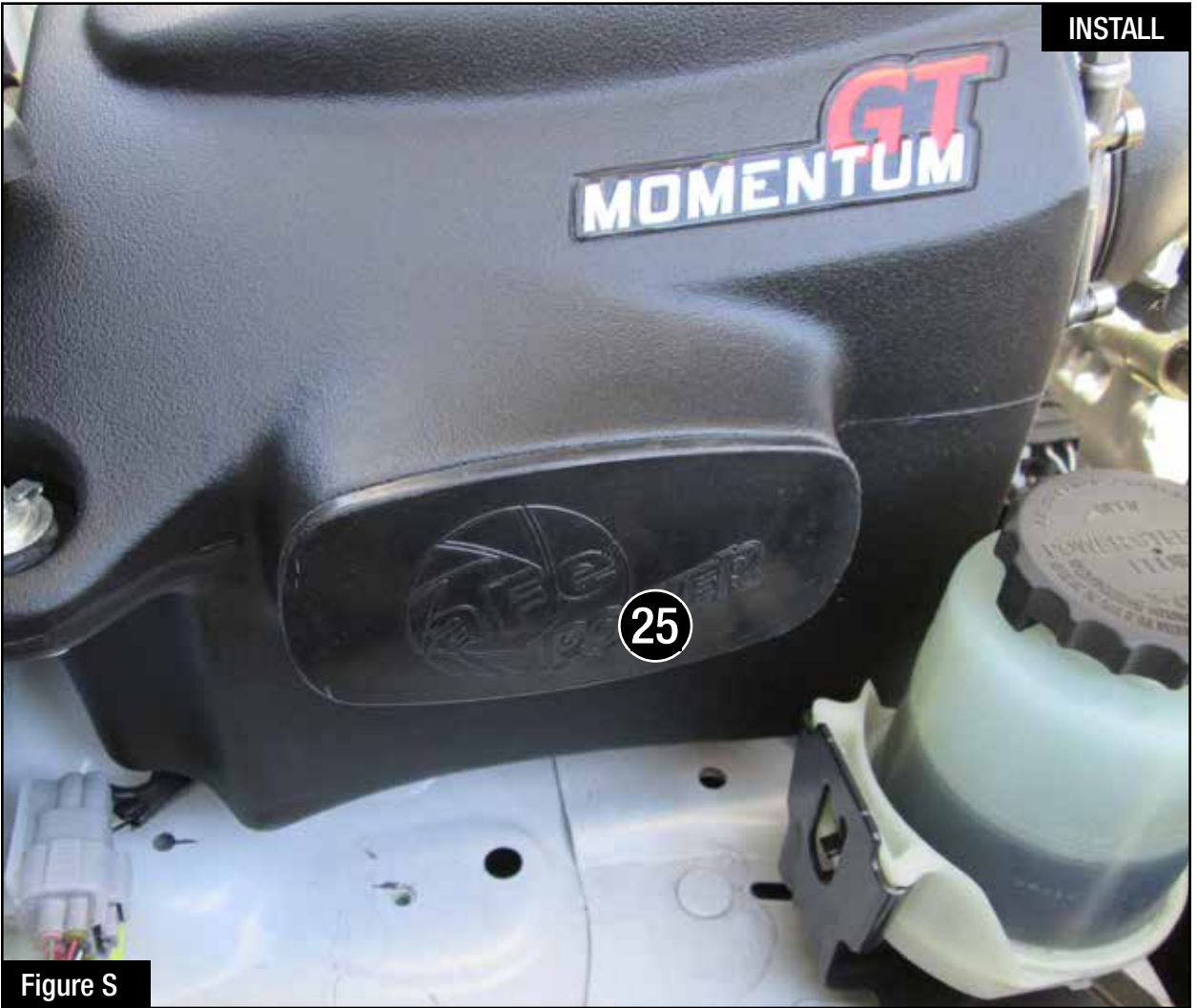

Figure R

**Refer to Figure R for Step 18**

Step 18: Connect the MAF sensor (24) .

**Figure S****Refer to Figure S for Step 19**

Step 19: Use the provided plug (25) to close additional air inlet if you want to completely seal the air box. Best performance gain is obtained by having more air flow (no plug).

INSTALL



Figure T

**Refer to Figure T for Step 20**

Step 20: Install the engine cover.



Figure U

**Refer to Figure U for Step 21**

Step 21: **Lexus Only:** Install the side cover with all 7 clips. Your installation is now complete. Thank you for choosing aFe Power!

**NOTE:** Check all bolts, clamps, and connectors after 200 miles.



Pro DRY S Air Filter



P/N: 21-91092

Pro 10R Air Filter



P/N: 20-91092

Pro-GUARD 7 Air Filter



P/N: 72-91092

Pro DRY S Restore Kit



P/N: 90-59999

Blue Squeeze Restore Kit



P/N: 90-50501

Gold Squeeze Restore Kit



P/N: 90-50500

Pre-Filter



P/N: 28-10283

aFe Motorsport T-Shirt



P/N: 40-30441-B (S)  
40-30442-B (M)  
40-30443-B (L)  
40-30444-B (XL)  
40-30445-B (2XL)



# Warranty

## General Terms:

- aFe warrants their products to be free from manufacturer's defects due to workmanship and material.
- This warranty applies only to the original purchaser of the product and is non-transferrable.
- Proof of purchase of the aFe product is required for all warranty claims.
- Warranty is valid provided aFe instructions for installation and/or cleaning were properly followed.
- Proper maintenance with regular inspections of product is required to insure warranty coverage.
- Damage due to improper installation, abuse, unauthorized repair or alteration is not warranted.
- Incidental or consequential damages or cost, including installation and removal of part, incurred due to failure of aFe product is not covered under this warranty.
- All warranty is limited to the repair and/or replacement of the aFe part. To request Return Goods Authorization ("RGA"). Upon receipt of the RGA, you must return the product to the address provided in the RGA, freight prepaid and accompanied with a dated proof of purchase and the RGA. Upon receipt of the defective product and upon verification of proof of purchase, aFe will either repair or replace the defective product within a reasonable time, not to exceed thirty days.

<b>Product Category</b>	<b>P/N Prefix</b>	<b>Warranty duration</b>
Direct OE Replacement Filters	10, 11, 30, 31, 71, 73	Life of the vehicle
Racing Filters	18	1 year
Universal	21, 24, 72	2 years
Air Intake Systems	50, 51, 54, 55, 75	2 years
Exhaust Systems	49	2 years
Intercoolers & Intercooler Tubes	46-2	2 years
Intake Manifolds	46-1	2 years
Differential Cover	46-7	Life of the vehicle
Exhaust Manifolds	46	2 years
Throttle Body Spacers	46-3	2 years
Fluid Filters	44	90 days
Pre-Filters	28	2 years
Heavy Duty OE Replacement	70	2 years
PowerSports OE Replacement	81, 87	2 years
PowerSports Intake Systems	85	2 years

No other warranty expressed or implied applies nor is any person or advanced FLOW engineering authorized to assume any other warranty. Some States do not allow the exclusion or limitation of incidental or consequential damages or do not allow limitations on how long an implied warranty lasts, so the above limitations or exclusions may not apply to you. This warranty gives you specific legal rights, and you may also have other rights which vary from State to State.