

GT
MOMENTUM™

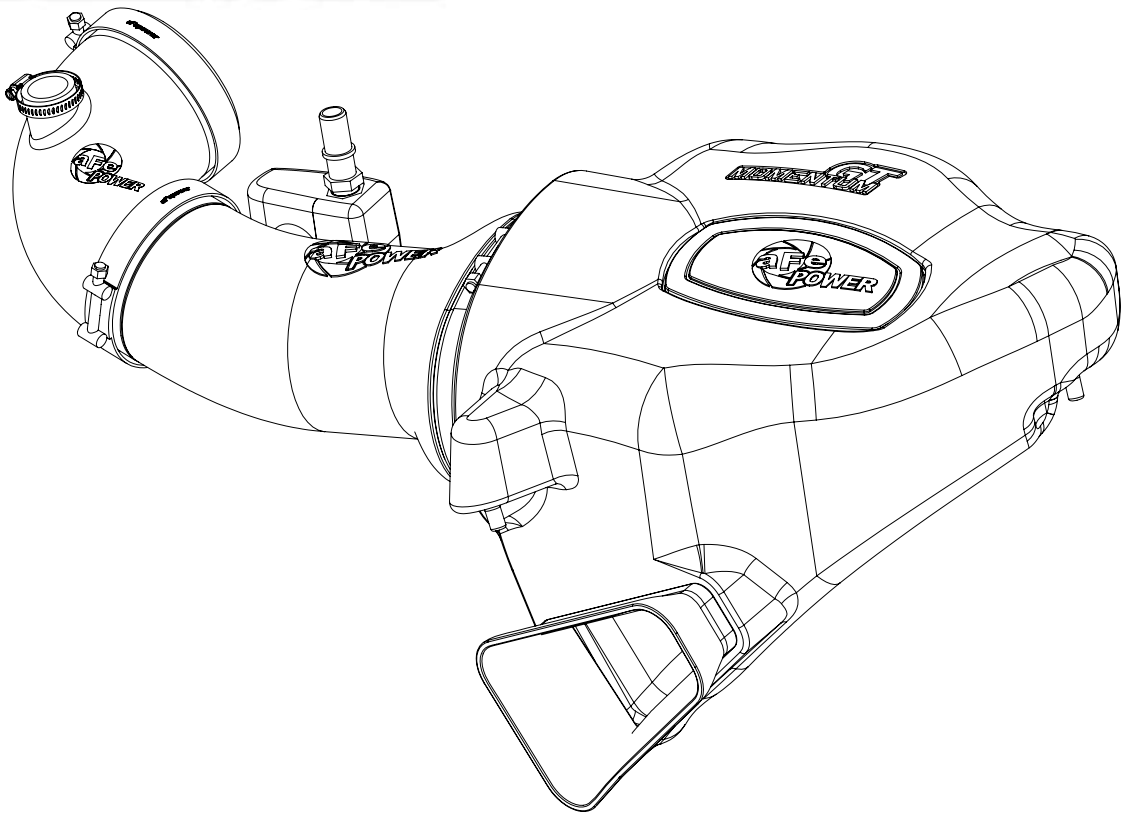

advanced FLOW engineering Momentum GT Cold Air Intake System

Instruction Manual P/N: 51-74210 / 54-74210

Make: **Chevrolet** Model: **Camaro SS** Year: **2016-2019** Engine: **V8-6.2L**



- Please read the entire instruction manual before proceeding.
- Ensure all components listed are present.
- If you are missing any of the components, call customer support.
- Ensure you have all necessary tools before proceeding.
- Do not attempt to work on your vehicle when the engine is hot.

Retain factory parts for future use.

Label	Qty.	Description	Part Number
A1	1	Air Filter (Pro 5R)	24-91092
A2	1	Air Filter (Pro DRY S)	21-91092
B	1	Tube	05-74210B1
C	1	Housing	05-74210B2
D	1	Clamp, #16	03-50091
E	1	Coupling, Silicone Elbow	05-01392
F	1	Fitting, Vent	03-01339
G	2	T-bolt Clamp	05-50262
H	2	Screw, M4	03-50491
I	1	Plug, Urethane	05-00937
J	1	Scoop	05-74210B3

Installation will require the following tools:

8mm nut driver, 11mm deep socket & driver, T20 Torx, flathead screwdriver, 20mm wrench or adjustable wrench and pliers.

Note: Legal in California for use on race vehicles only. The use of this device on vehicles used on public streets or highways is strictly prohibited in California and others states that have adopted California emission regulations.

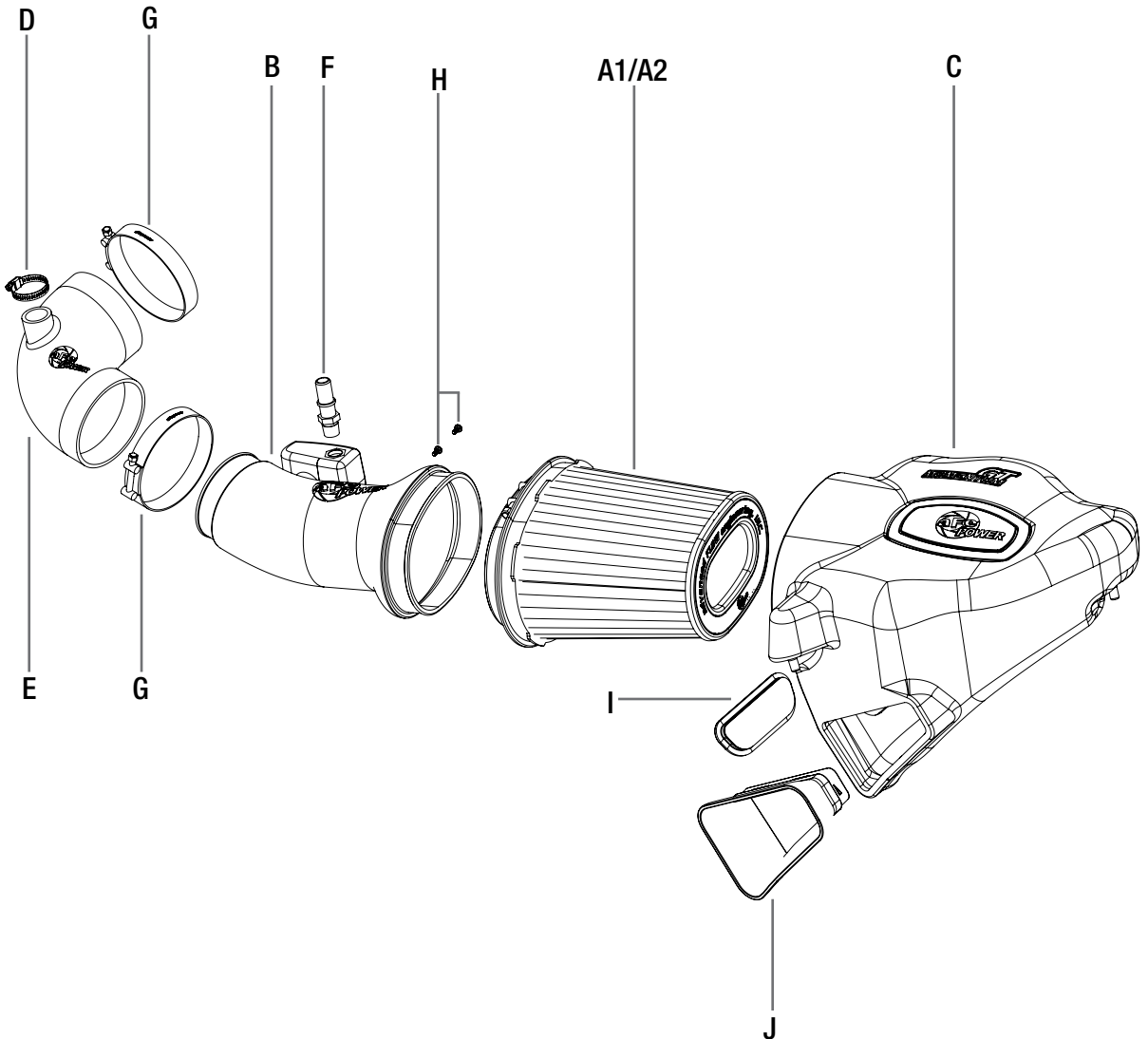

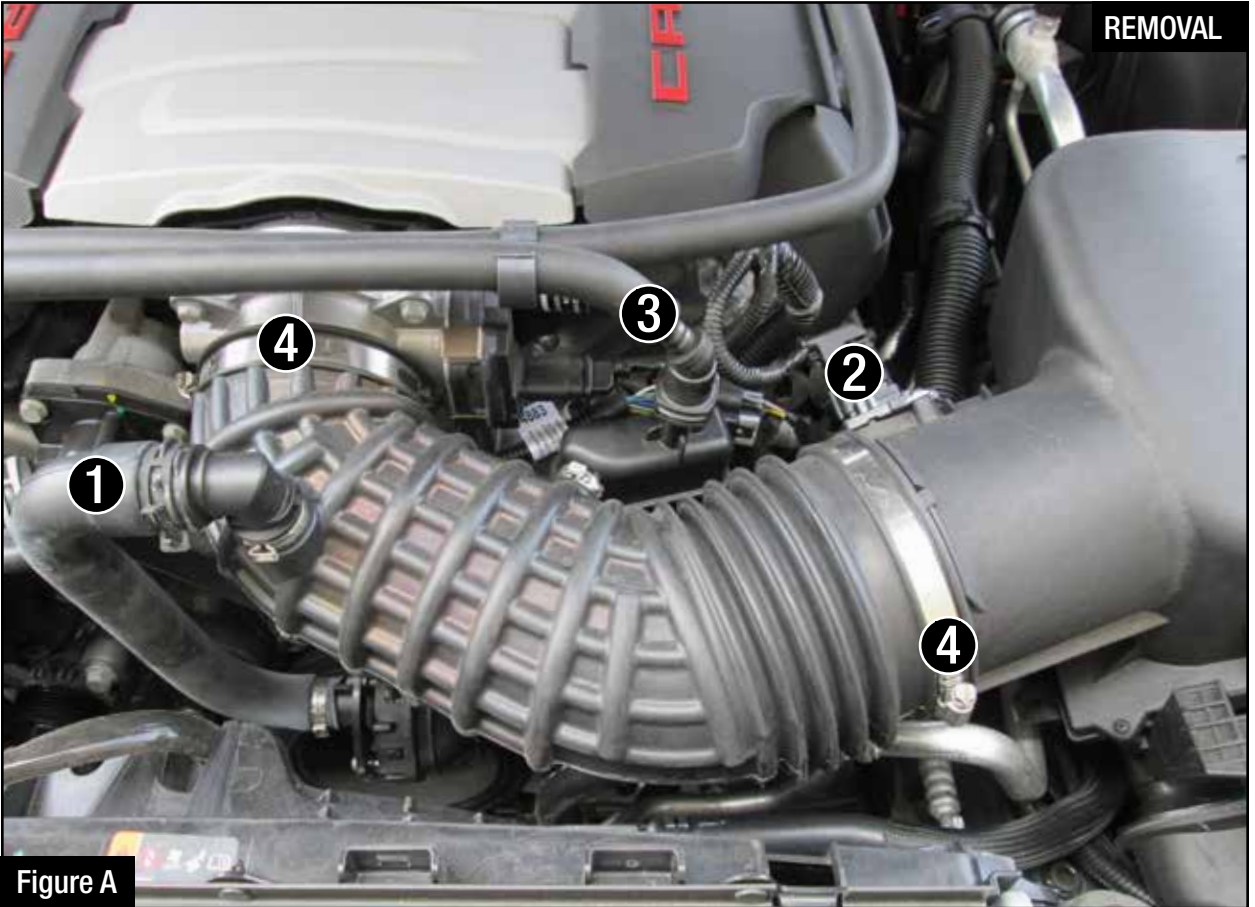
**Figure A****Refer to Figure A for Steps 1-2**

Step 1: Using a pair of pliers, disconnect the sound hose (1) from the intake tube. Disconnect the MAF sensor (2) and the breather hose (3) from the intake tube .

Step 2: Use an 8mm nut driver to loosen the stock clamps (4) at the throttle body and the air box. Remove the stock intake tube.

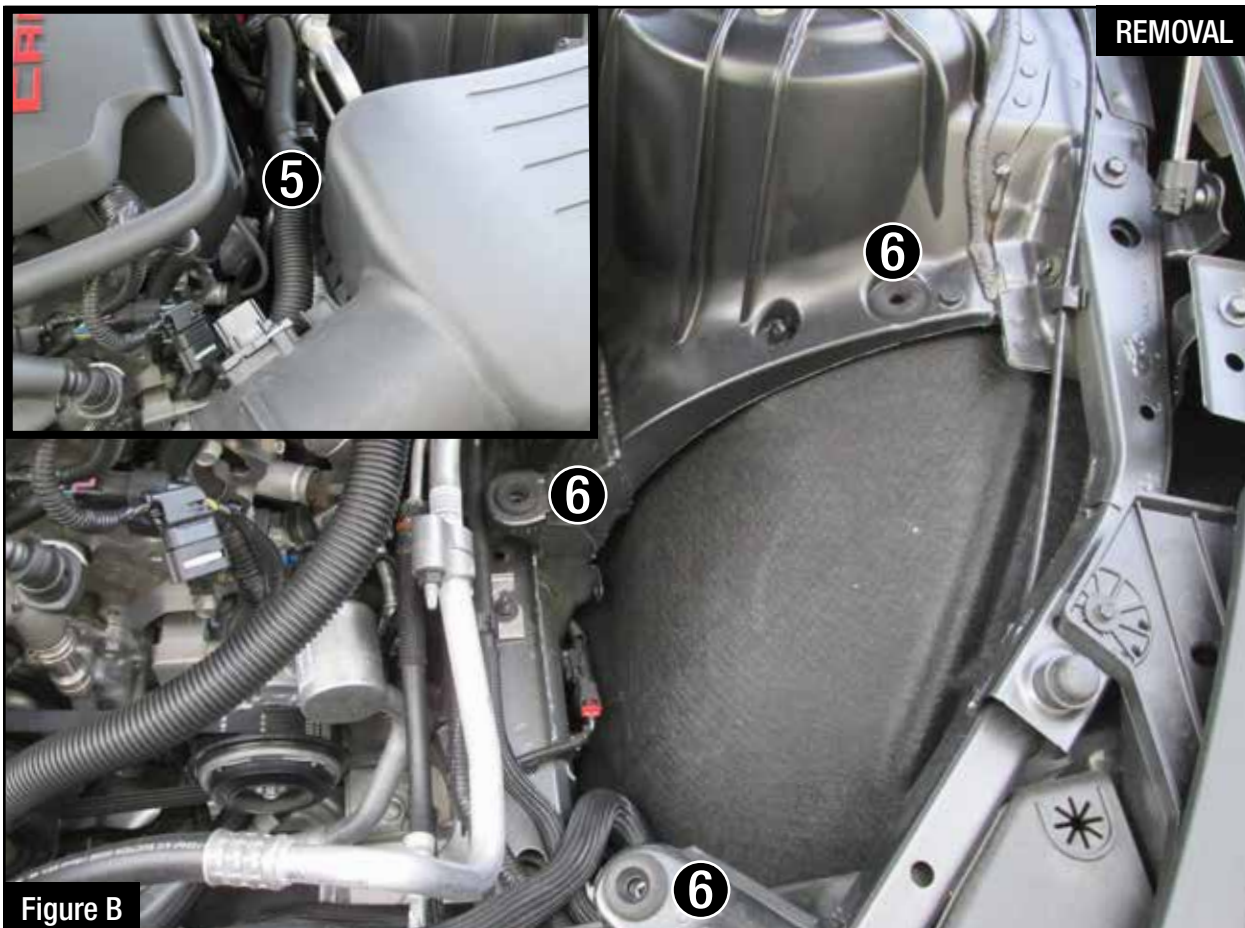

Figure B

Refer to Figure B for Steps 3-4

Step 3: Remove the air hose from the captive clamp (5) and move it to the side.

Step 4: Remove the air box by pulling up to release air box from its mounting grommets (6). Make sure the mounting grommets (6) are still in the chassis mounting tabs. If they pulled out and are stuck in the lower half of the air box, remove them from the air box and insert them back on the chassis mounting tabs.



Figure C

Refer to Figure C for Steps 5-6

Step 5: Install the supplied air inlet scoop (7) into the aFe air box.

Step 6: Use the provided plug (8) to close additional air inlet if you want to completely seal the air box.

Best performance gain is obtained by having more air flow (no plug).



Figure D

Refer to Figure D for Step 7

Step 7: Slide the aFe filter and clamp into the aFe housing and push it in until it locks into place. Do not tighten clamp at this time.



Figure E

Refer to Figure E for Step 8

Step 8: Install the housing assembly into the vehicle by pushing down air box pins into the rubber grommets. Make sure the pins are completely through the mounting grommets.



Figure F

Refer to Figure F for Step 9

Step 9: Using a Torx 20 driver remove the mass air flow sensor (8) from the upper half of the air box and set it aside.



Refer to Figure G for Step 10

Step 10: Install the supplied aluminum vent fitting (9) into the aFe intake tube using a 20mm wrench or adjustable wrench.

Install the mass air flow sensor (10) in the aFe intake tube using the two supplied M4 screws.

INSTALL



Figure H

Refer to Figure H for Step 11

Step 11: Install the aFe intake tube into the air filter.

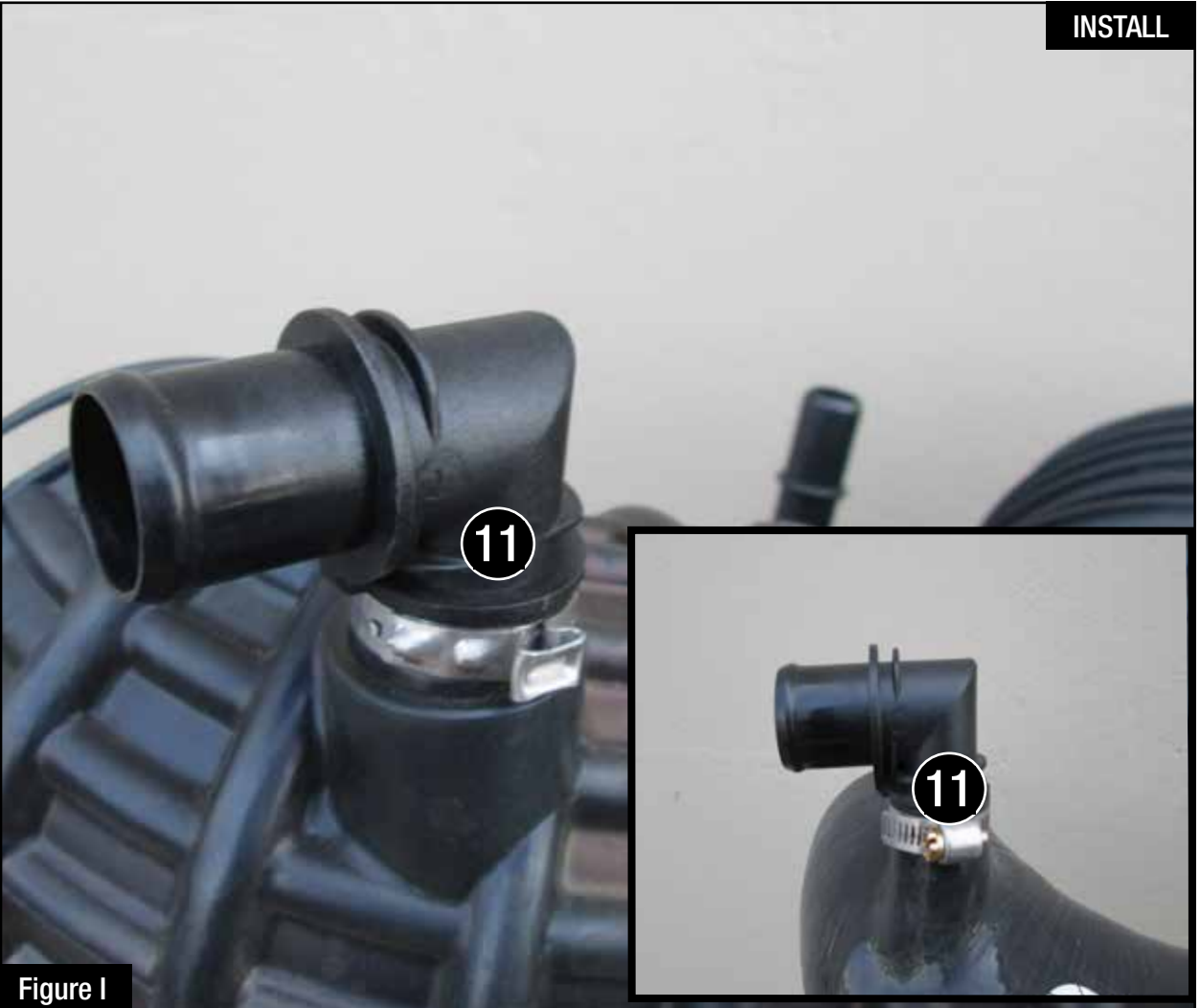

Figure I

Refer to Figure I for Step 12

Step 12: Remove the elbow fitting (11) from the intake hose by prying the clamp with a flathead screwdriver and install it on the supplied silicone coupler with the supplied mini clamp.

INSTALL



Figure J

Refer to Figure J for Step 13

Step 13: Install the silicone coupler with the supplied T-clamps onto the throttle body and intake tube. Tighten all clamps.

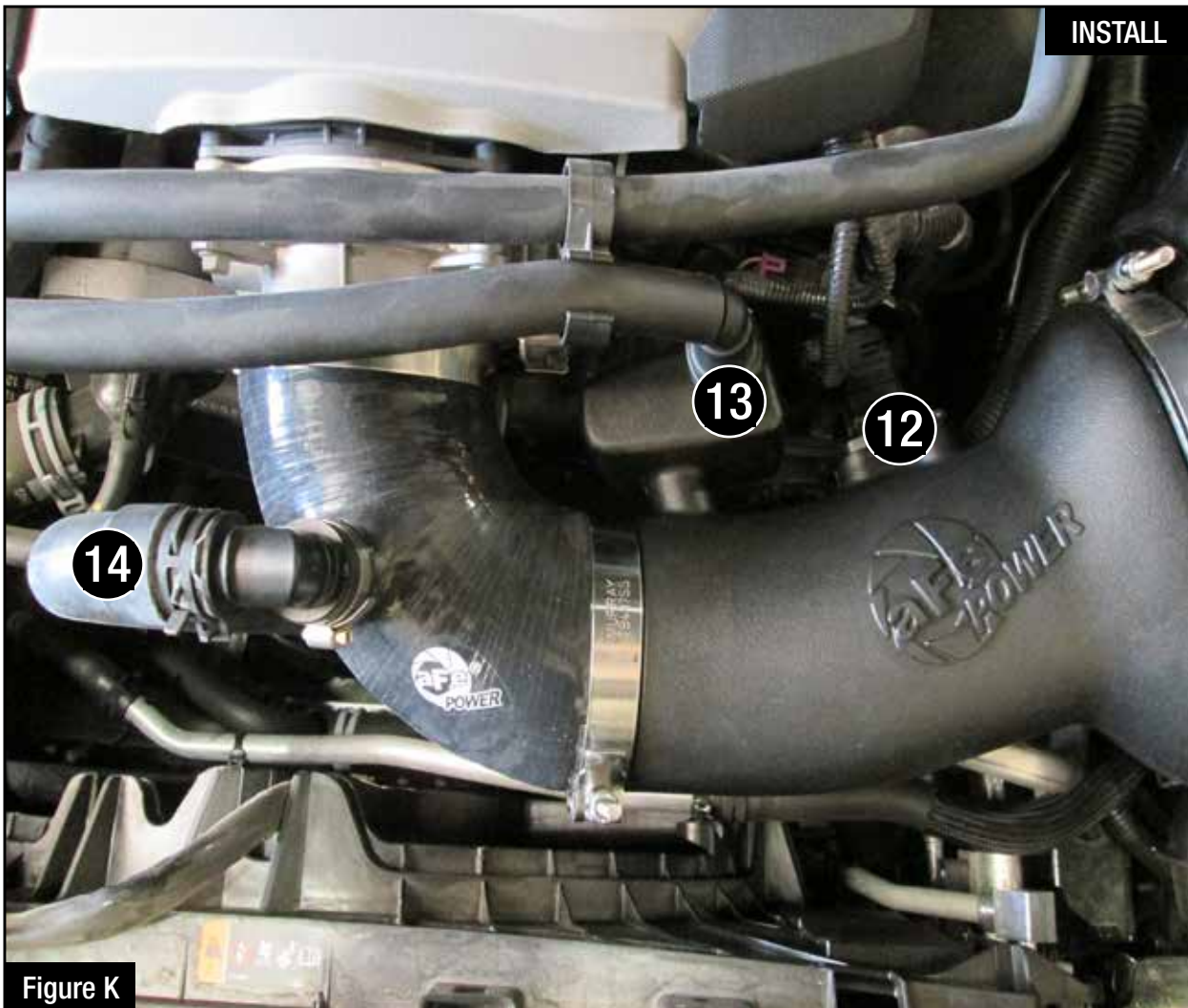

Figure K

Refer to Figure K for Step 14

Step 14: Connect the mass air flow sensor (12), breather hose (13) and sound hose (14). Check all the components are tight and secure.



Figure L

Refer to Figure L for Step 15

Step 15: Your installation is now complete.

NOTE: Check all bolts, clamps, and connectors after 200 miles.



Pro DRY S Air Filter



P/N: 21-91092

Pro 5R Air Filter



P/N: 24-91092

Pre-Filter



P/N: 28-10283

Pro DRY S Restore Kit



P/N: 90-59999

Blue Squeeze Restore Kit



P/N: 90-50501

Headers w/ X-Pipe



P/N: 48-34127-YC (Street)
48-34127-YN (Race)

Lowering Springs

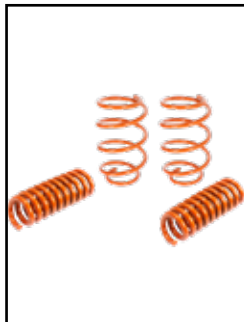

P/N: 410-402002-N

Sway Bars

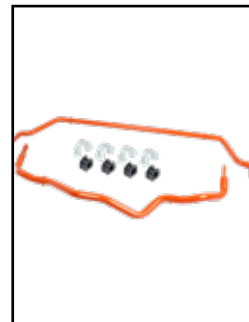

P/N: 440-402002-N

aFe T-Shirt



P/N: 40-30382 (M)
40-30383 (L)
40-30384 (XL)