

advanced FLOW engineering Quantum Cold Air Intake System

Instruction Manual P/N: 53-10030D / 53-10030R

Make: Chevrolet
Make: GMC

Model: Silverado 1500
Model: Sierra 1500

Year: 2014-2019
Year: 2014-2019

Engine: V8-5.3L/6.2L
Engine: V8-5.3L/6.2L



- Please read the entire instruction manual before proceeding.
- Ensure all components listed are present.
- Ensure you have all necessary tools before proceeding.
- Do not attempt to work on your vehicle when the engine is hot.
- Disconnect the negative battery terminal before proceeding.
- Retain factory parts for future use.

Label	Qty.	Description	Part Number
A1	1	Air Filter (Pro 5R)	23-91129
A2	1	Air Filter (Pro DRY S)	21-90098
B	1	Tube	05-5310030B1
C	1	Housing	05-54006B2
D	1	Seal, Trim: 7/16" Bulb (26"L)	05-00072
E	1	Clamp, 080 (3-1/2" – 5-1/2")	03-50011
F	1	Clamp, 072 (3" - 5")	03-50010
G	1	Coupling, Silicone Bellow	05-01457
H	1	Coupling, Silicone Reducer	05-01358
I	1	Coupling, Silicone Hump	05-01314
J	2	Clamp, 060 (3-5/16" - 4-1/4")	03-50002
K	1	Clamp, 056 (3-1/16" - 4")	03-50009
L	2	Screw, Torx: M4 x .7 x 8mm	03-50491
M	1	Hose, Silicone Breather, Black (13"L)	05-01396
N	1	Hose, Silicone Breather, Black (16"L)	05-01396

Installation will require the following tools:

8mm nut driver, T15 & T20 Torx drivers, Phillips #3 screwdriver, small flat-head screwdriver.

Emissions Disclaimer: This product is not currently CARB exempt and is not available for purchase in California or for use on any vehicle registered with the California Department of Motor Vehicles.

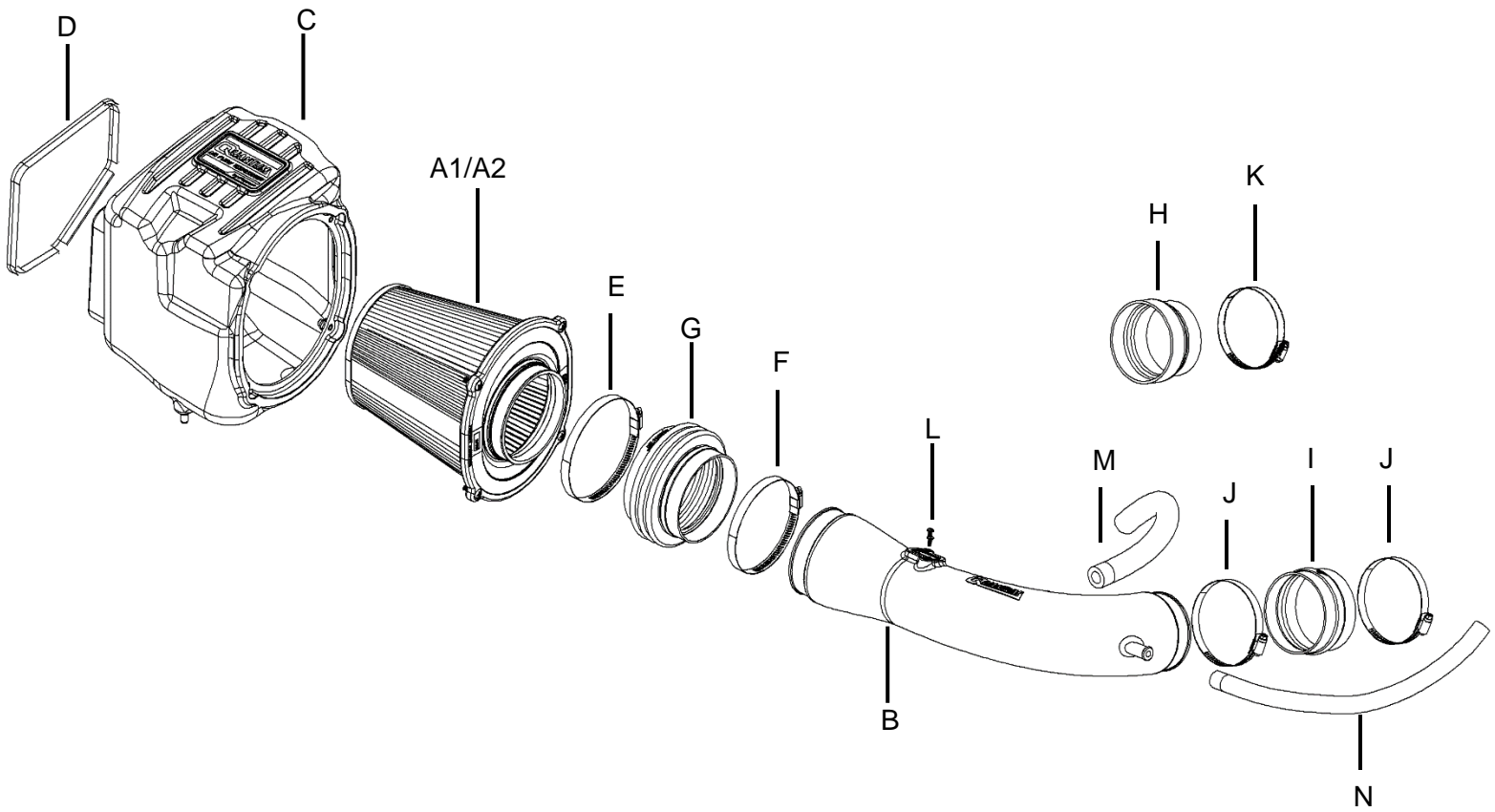

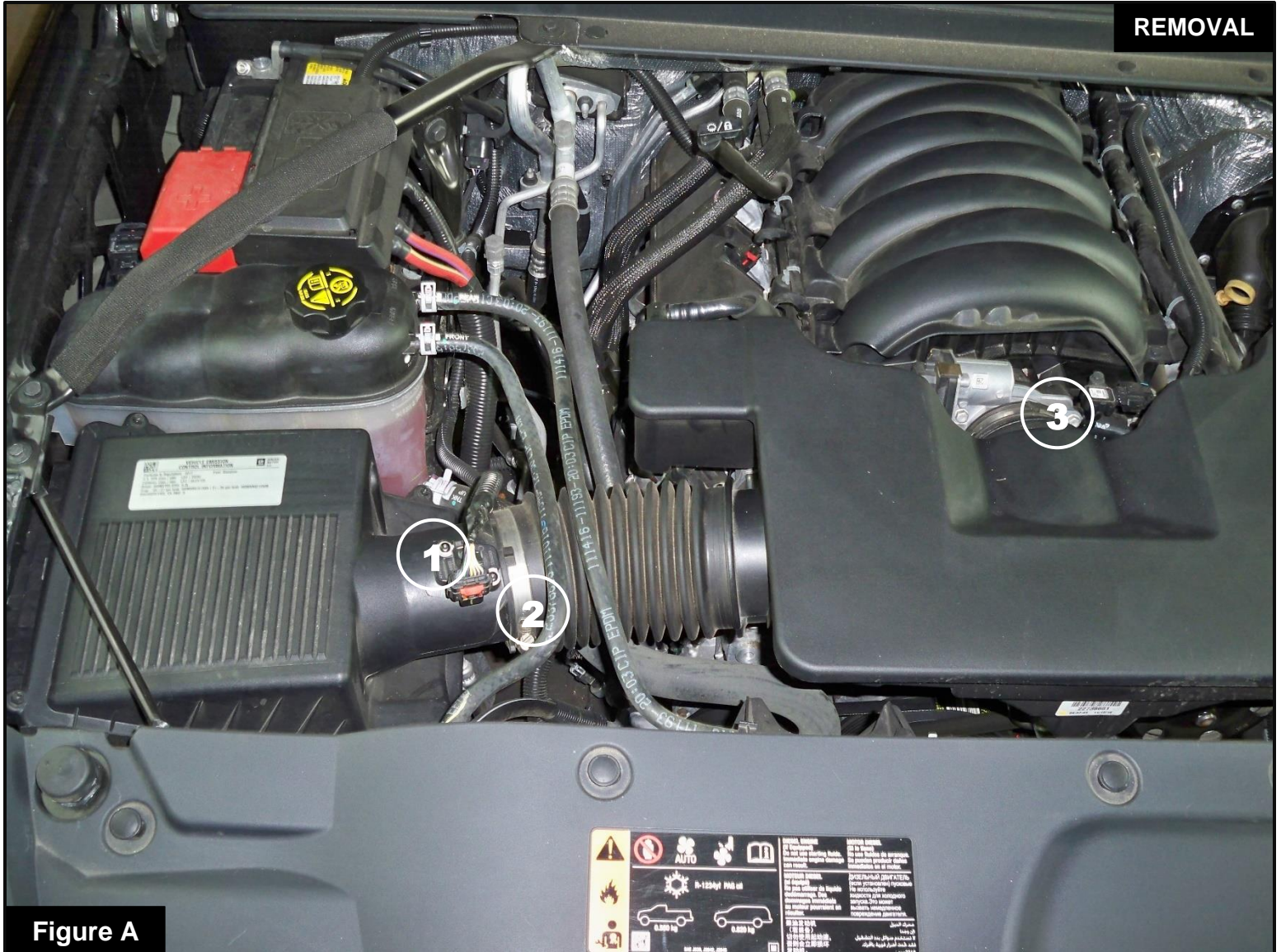
**Figure A****Refer to Figure A for Steps 1-2**

Step 1: Disconnect the MAF sensor ①.

Step 2: Using an 8mm nut driver, loosen the hose clamps at the housing ② and the throttle body ③.

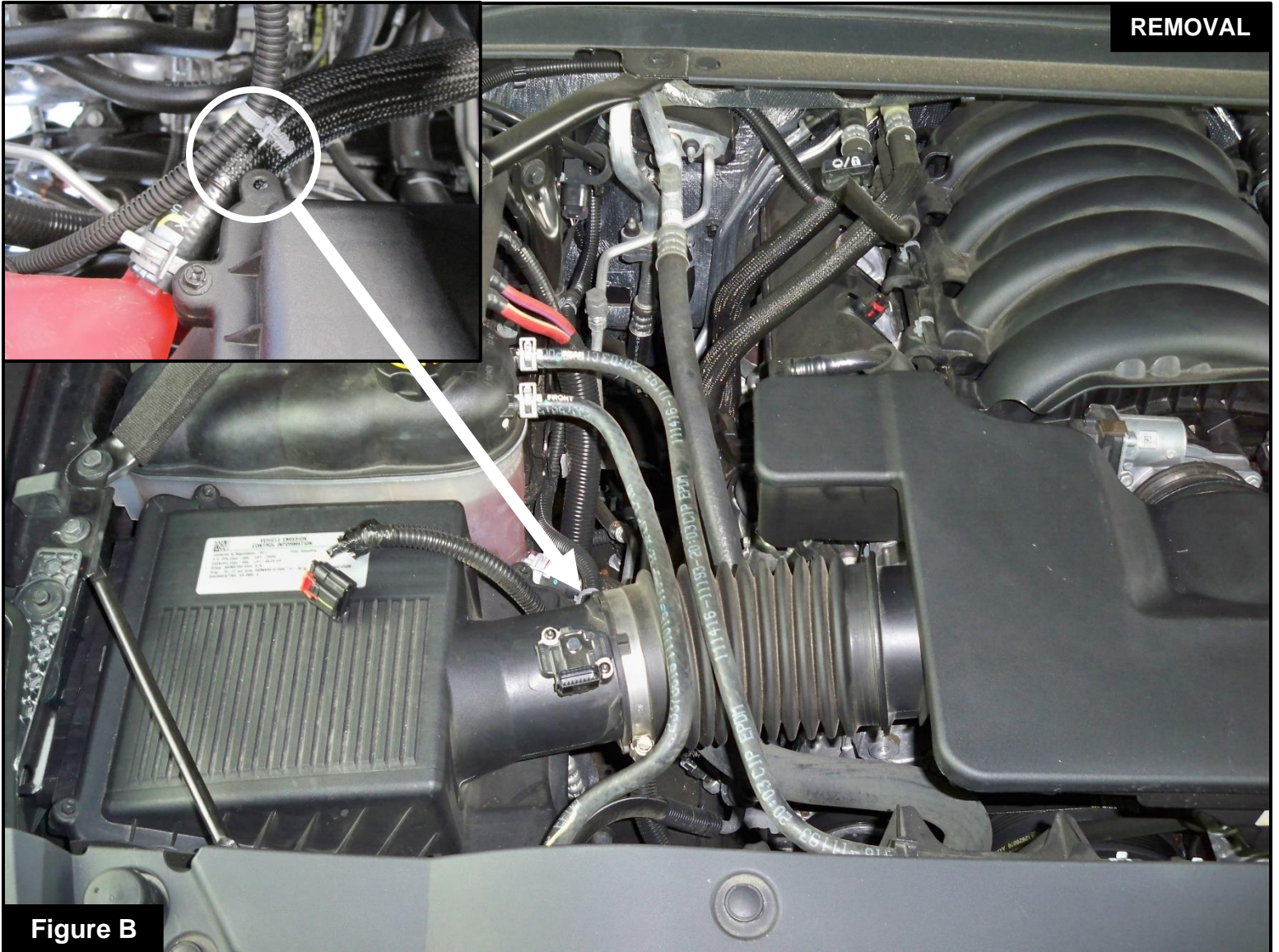
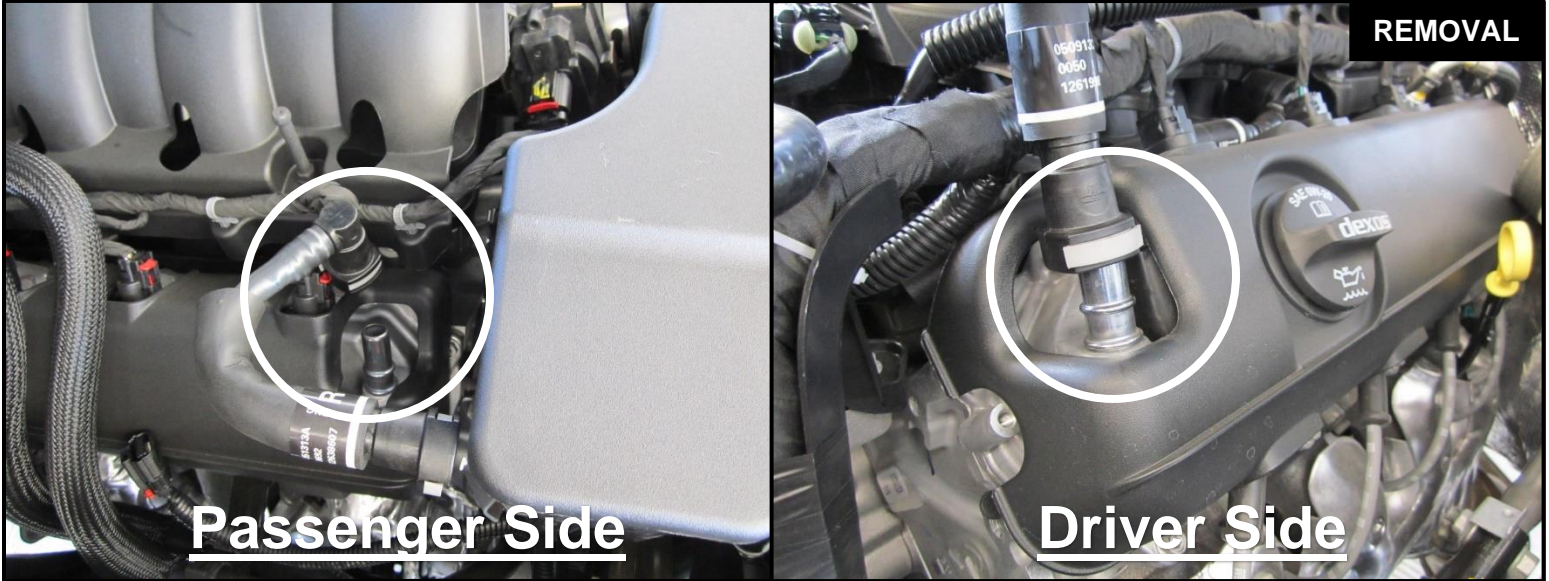

Figure B

Refer to Figure B for Step 3

Step 3: Disconnect the MAF sensor harness clip from the OE housing.



Refer to Figure C for Steps 4-5

Step 4: Disconnect the OE crankcase breathers from the valve covers (as shown) on both sides of the engine.

Step 5: Carefully remove the entire intake tube plenum with the crankcase breather plugs attached.

**Figure D****Refer to Figure D for Step 6**

Step 6: Remove the factory housing ④ out of the vehicle.

**Figure E****Refer to Figure E for Steps 7-8**

Step 7: Slide the aFe filter into the aFe housing. Install the aFe filter using a #3 Phillips screwdriver. Tighten all (x4) screws.

Step 8: Install the supplied bellows coupling (5) onto the air filter using the supplied #80 clamp (6). Tighten the clamp.



Figure F

Refer to Figure F for Steps 9-10

Step 9: Install the trim seal (7) on the opening of the aFe housing.

Step 10: Remove the retaining plug (8) from the bottom of the factory housing and transfer it to the aFe housing.



Figure G

Refer to Figure G for Step 11

Step 11: Install the aFe housing assembly into the vehicle. Firmly push the housing into the factory mounting grommets.

**Figure H****Refer to Figure H for Steps 12-13**

Step 12: Remove the MAF sensor (9) from the factory housing using a T15 Torx driver.

Step 13: Using a T20 torx driver, install the MAF sensor into the aFe intake tube using the supplied M4 screws. Make sure the factory seal is still attached to the MAF sensor.

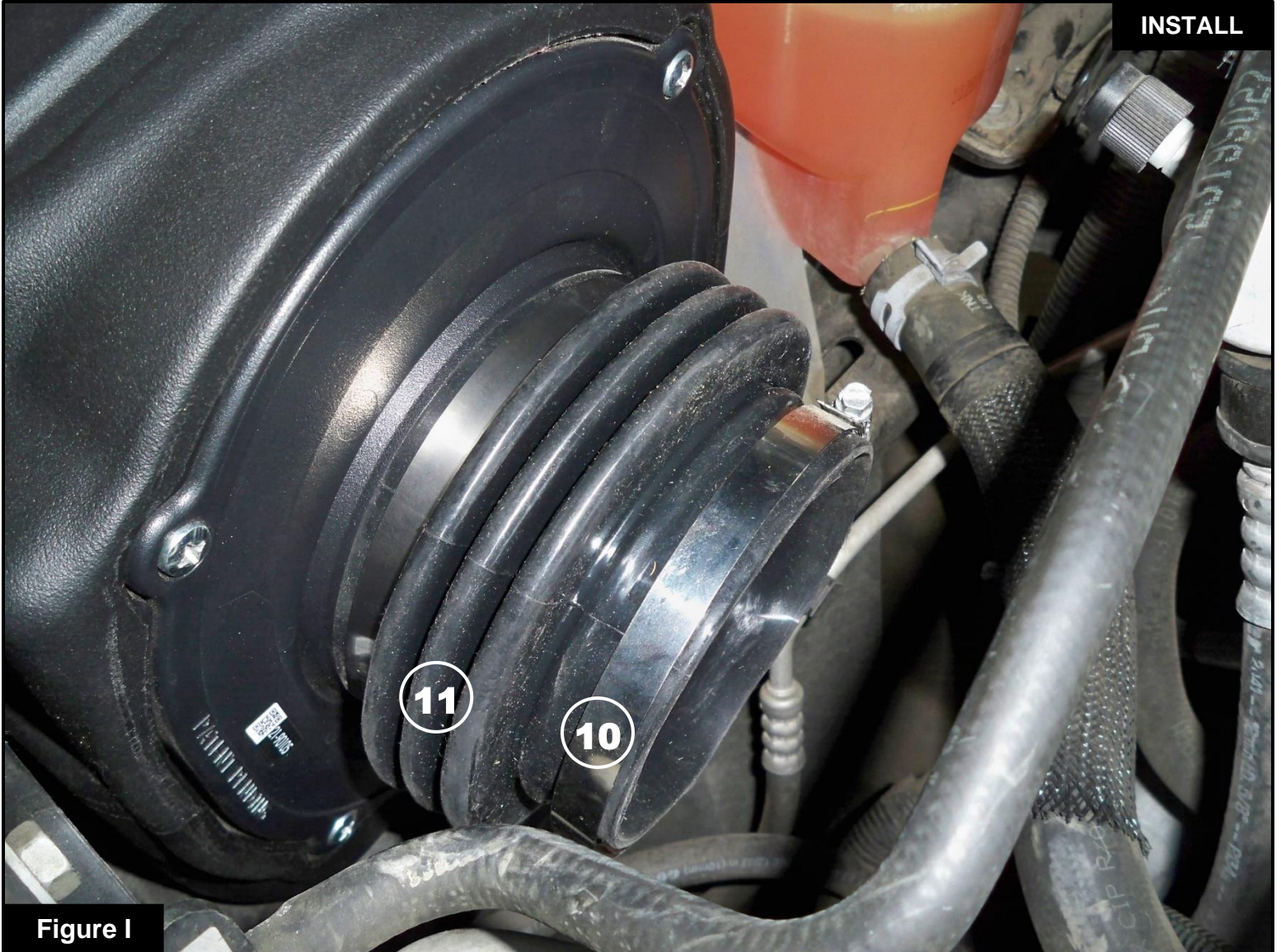

Figure I

Refer to Figure I for Step 14

Step 14: Place the #72 clamp (10) onto the filter coupling (11). Do NOT tighten the clamp.



Refer to Figure J for Steps 15-18

- Step 15: For V8-6.2L, install the supplied hump coupling and the #60 clamps on the throttle body.
- Step 16: For V8-5.3L, install the supplied reducer coupling with the smaller diameter on the throttle body and the #56 clamp. Place a #60 clamp on the other end of the coupling. Do not tighten the clamps at this time.
- Step 17: Install the aFe intake tube (12) into the vehicle. Slide the aFe intake tube into the filter coupling and then into the coupling on the throttle body.
- Step 18: Align the aFe intake tube correctly then tighten all the clamps.

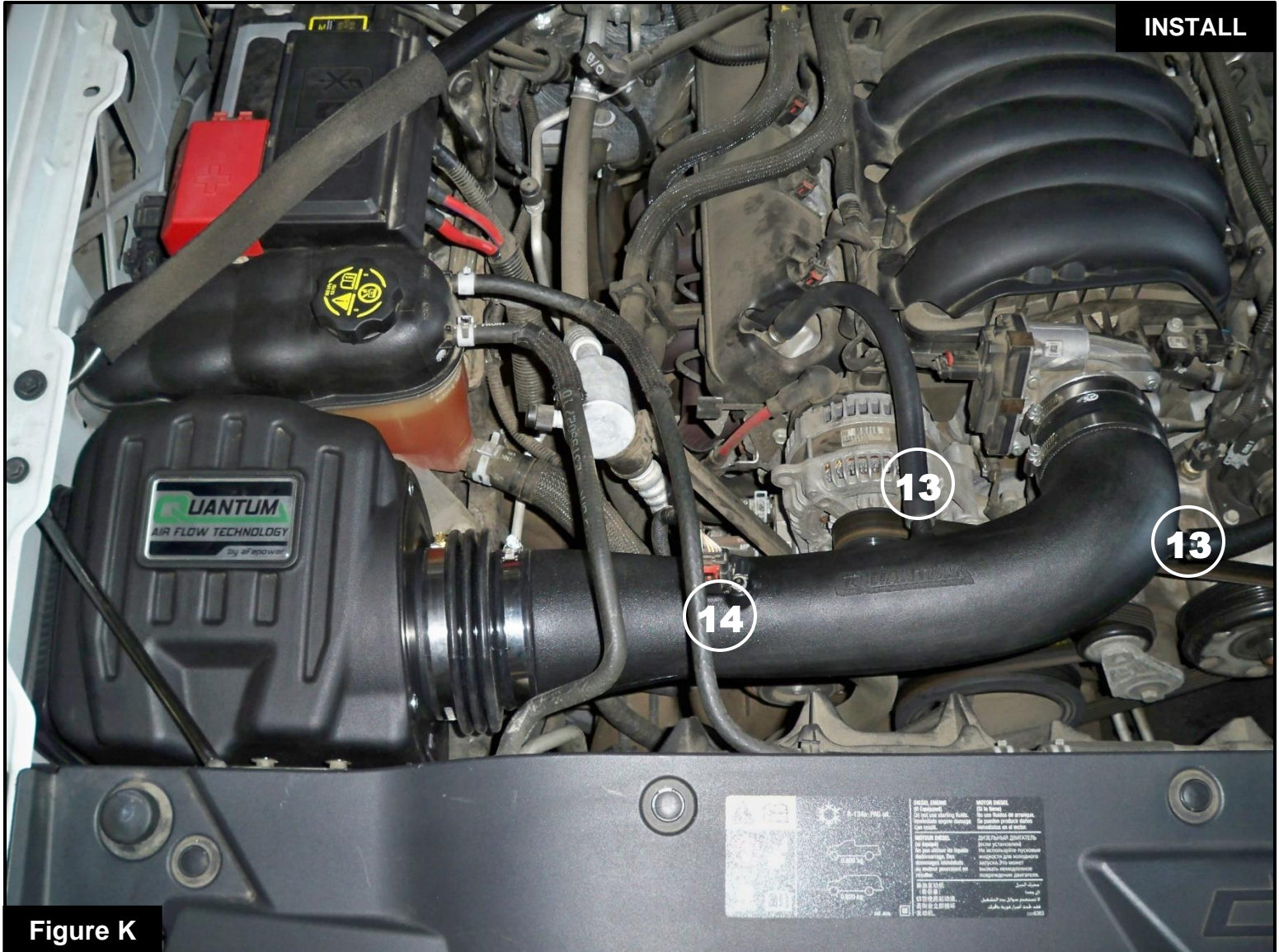

Figure K

Refer to Figure K for Steps 19-21

Step 19: Install the two supplied crankcase breather hoses (13) between the valve cover and the aFe intake tube on both passenger and driver side. (Make sure the hoses are secure all the way to the bead on the valve covers).

Step 20: Reconnect the MAF sensor (14).

Step 21: Check all the components are tight and secure. Your installation is now complete. Thank you for choosing aFe POWER!

NOTE: Check all screws, clamps, and connectors are secure after 100-200 miles.



Pro DRY S Air Filter Inv.



P/N: 21-91129

Pro 5R Air Filter Inv.



P/N: 23-91129

Pro-GUARD 7 Air Filter Inv.



P/N: 72-91129

Pro DRY S Air Filter



P/N: 21-90098

Pro DRY S Restore Kit



P/N: 90-59999

Blue Squeeze Restore Kit



P/N: 90-50501

Gold Squeeze Restore Kit



P/N: 90-50500

Pre-Filter



P/N: 28-10423

SCORCHER PRO Tune



P/N: 77-34004

Sprint Booster



P/N: 77-14003

Silver Bullet TBS 5.3L

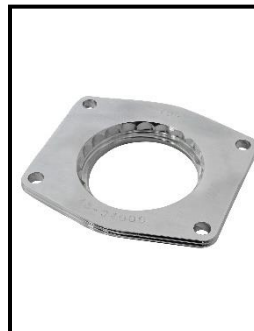

P/N: 46-34008

Silver Bullet TBS 6.2L



P/N: 46-34016