



INSTALLATION INSTRUCTIONS

MAKE: Jeep
MODEL: JK
YEAR: 07-18
ENGINE: V6-3.6L/3.8L

Cat-Back Exhaust
 (304SS) 49-38086-B/P
 (409SS) 49-48086-B/P

NOTE: Will fit 2 & 4 Door

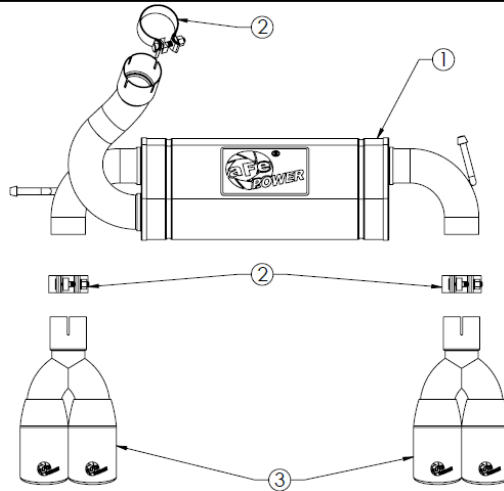

Item	Description	Part Number	Quantity
1	Muffler Assembly (409SS)	05-244013	1
1	Muffler Assembly (304SS)	05-245013	1
2	Clamp, Band: 2-1/2"	05-41061	1
3	EXH Tip 2-1/2 In x 3-1/2 Out x 12L Bolt-On Blk	R49T25374-B-12	2
3	EXH Tip 2-1/2 In x 3-1/2 Out x 12L Bolt-On Polished	R49T25374-P-12	2

aFe POWER recommends professional installation on this product. Thoroughly inspect the aFe POWER exhaust system to make sure there is no damage from shipping (if damage is noted, immediately contact aFe POWER customer service). Allow time for your vehicle to cool down prior to installation. When working on your vehicle proceed with caution. Wear protective safety equipment; eye goggles and gloves to ensure a safe installation.

Install band clamps to proper torque specifications of 40-45 ft-lb.





INSTALLATION INSTRUCTIONS

MAKE: Jeep
MODEL: JK
YEAR: 07-18
ENGINE: V6-3.6L/3.8L

Cat-Back Exhaust
(304SS) 49-38086-B/P
(409SS) 49-48086-B/P

NOTE: Will fit 2 & 4 Door

1. **(Read instructions prior to installation.)** It is recommended to not fully tighten the exhaust until it has been fully installed. Leave loose for adjustability.
2. Secure vehicle on jack stands (refer to your manual for specified jack stand positions).
3. For faster installation, spread out the parts of the exhaust alongside your vehicle as shown in the diagram above.
4. Secure the stock exhaust with jack/stands.
5. Remove the O.E. axle-back.
6. Install the new aFe POWER axle-back using the provided 2.5" band clamps. Then slide the hangers into the O.E isolation mounts.
7. Install the aFe POWER tips using the provided 2.5" band clamps.
8. Ensure that all the components of the aFe POWER exhaust system are aligned and are at a safe clearance from all wires, hoses, brake lines, body parts, and tires.
9. Start from the front of the aFe exhaust system and evenly tighten all clamps and fasteners.
10. Start the vehicle and check for any leaks. If any leaks are found, determine cause and repair as necessary.
11. Remove vehicle from jacks stands.
12. It is recommended to re-tighten all clamps and hardware after 50-100 miles.