



Equipped with AEM® *Dryflow™* Filter  
No Oil Required!

# INSTALLATION INSTRUCTIONS

## PART NUMBER:22-435

---

2003-2006

mitsubishi Lancer Evolution L4-2.0L

C.A.R.B. E.O. # D-670

**PARTS LIST**

<b>Description</b>	<b>Qty.</b>	<b>Part Number</b>
Air Filter Assy 6.00 X 5"4.75"	1	21-209DK
Short Pipe	1	2-4351
Heat Shield	1	20-435
Adapter, MAF/AF	1	2-681
Bracket, Lancer Evo	1	32-3026
Adapter Base	1	32-3027
Hose, Adapter 2.50/3.00 X 3" 45	1	5-273-45
Hose, Silicone 3.00x2" Black	1	5-302
Mount, Rubber 1" X 6mm	1	1228599
Grommet, 1/8"	1	784631
Rubber Edge Trim 17"	1	8-3017
Hose, 1-1/4I.D. X 1.5" Long	1	65005-1
Connector, Plastic 1/8" Straight	1	8-103
Bolt, Hex/Flange M6-1 X 20	5	1-2038
Washer, M6 X 12mm OD Zinc	4	1-3018
Washer, 6mm Soft Mount	2	559999
Nut, M6 Hex Serrated	5	444.460.04
Hose Clamp, 1.5	1	103-BLO-2420
Hose Clamp, 3/4"	1	4093-5
1/2" Bnd. Hose Clamp, 2.31-3.25"	1	9444
1/2" Bnd. Hose Clamp, 2.56"-3.50"	2	9448
1/2" Bnd. Hose Clamp, 2.90"-3.75"	1	9452
1/2" Bnd. Hose Clamp, 4.125-7.00"	1	94104

Read and understand these instructions **BEFORE** attempting to install this product. Failure to follow installation instructions and not using the provided hardware may damage the intake tube, throttle body and engine.

## 1. Preparing Vehicle

- a. Make sure vehicle is parked on level surface.
- b. Set parking brake.
- c. If engine has run in the past two hours, let it cool down.
- d. Disconnect negative battery terminal.
- e. Do not discard stock components after removal of the factory system.

## 2. Removal of stock system

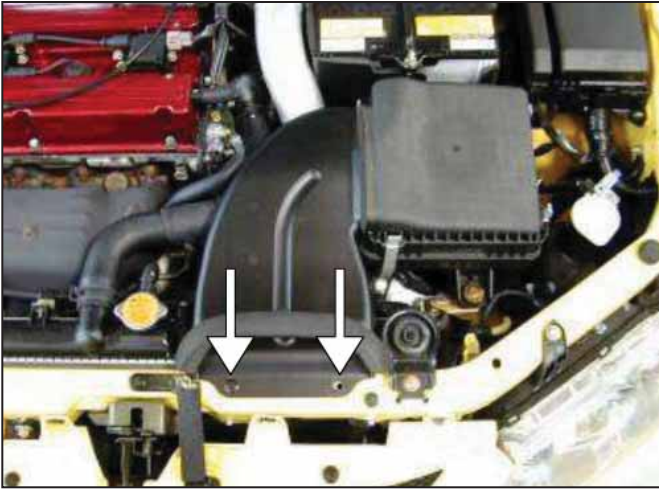

a. Push in the inner circle on the clips to remove them. Remove both clips. Remove inlet duct to air box.



b. Locate the 4 clips on each corner of the air box.

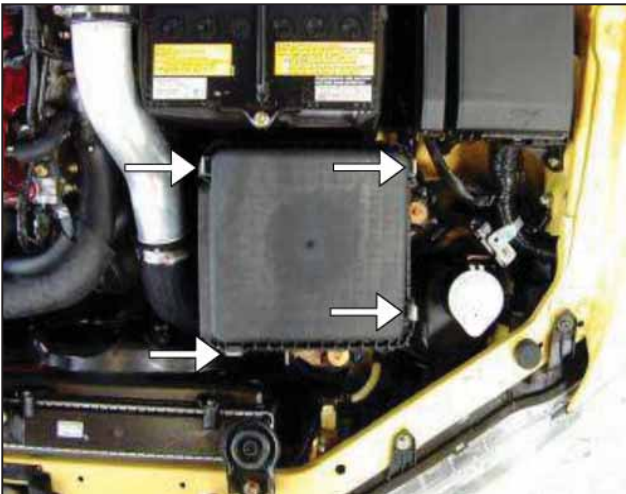

c. Unfasten the 4 clips that hold down the top to the air box. Remove the air box top.

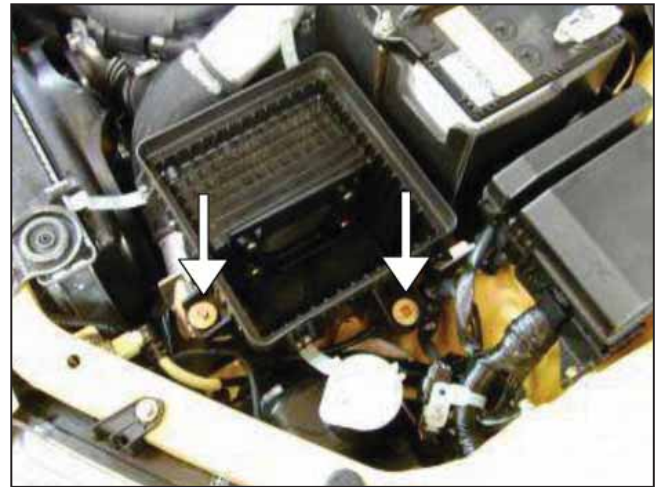

d. Remove the filter element. Remove the bolts holding down the bottom portion of the air box.



e. Loosen the hose clamp connected to the bottom portion of the air box.  
**NOTE: Do not loosen the worm gear type hose clamp located on the charge pipe.**



f. Disconnect the MAF sensor harness from the bottom portion of the air box. Carefully remove the bottom portion of the air box. The honeycombs in the MAF sensor are sensitive, take note not to damage during removal.

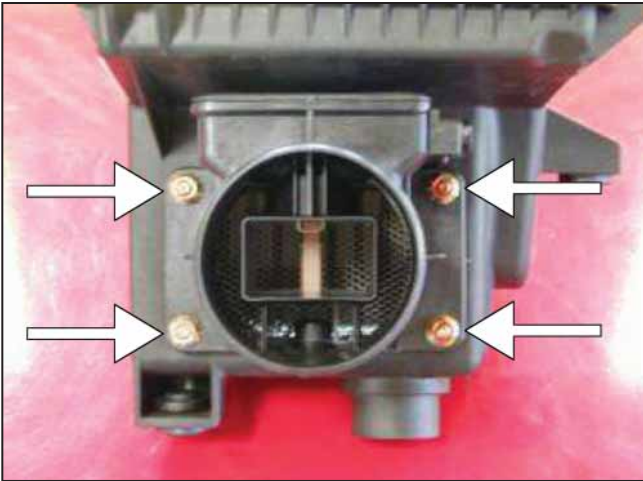

g. Carefully remove the 4 bolts holding the MAF sensor to the bottom portion of the air box. Check the MAF sensor gasket for tears or cracks. Replace as necessary.



h. Loosen the hose clamp connecting the blow off valve to the turbo inlet hose. Disconnect the blow off valve from the inlet hose. Remove hose clamp from the inlet hose.



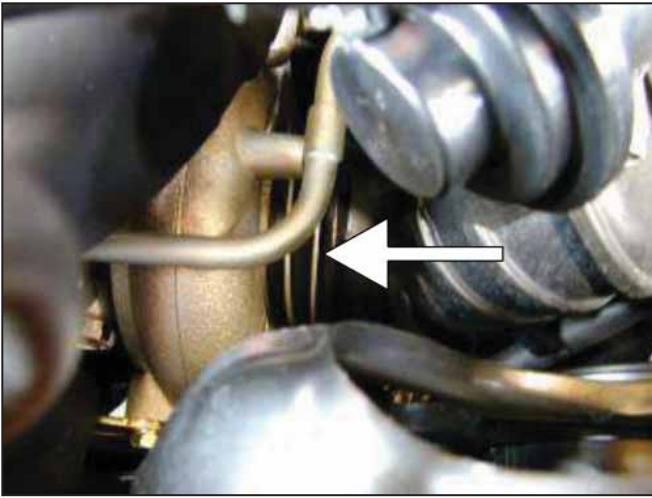

i. Loosen the hose clamp on the turbo inlet hose at the turbo. This double ring clamp is similar to the clamp in step 2e.



j. Disconnect the crankcase breather tube at the turbo inlet hose.

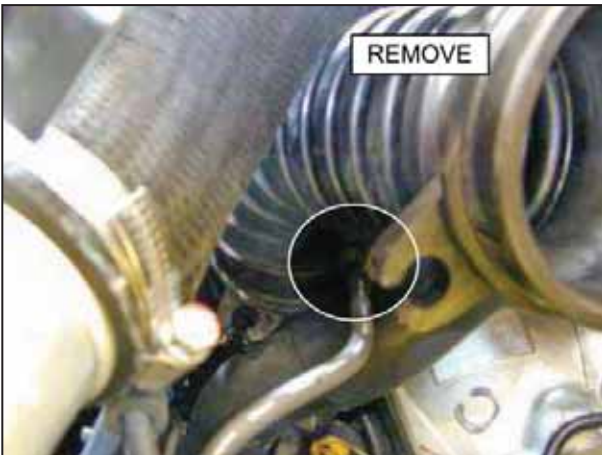

k. Disconnect vacuum line from the boost solenoid to the turbo inlet hose. The vacuum line is located underneath the turbo inlet hose. Remove the turbo inlet hose.

### 3. Installation of AEM® intake system.

a. When installing the intake system, do not completely tighten the hose clamps or mounting hardware until instructed to do so.



b. Assemble the 45 degree coupler as shown with hose clamps attached loosely.



c. Attached assembled coupler to the turbo inlet as shown.

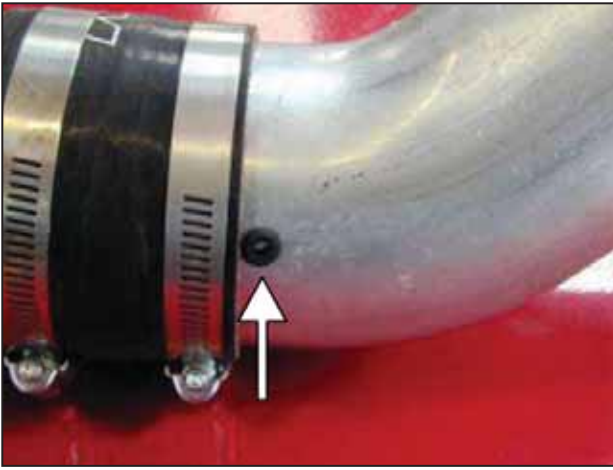

d. Insert rubber grommet to the underside of the inlet pipe.

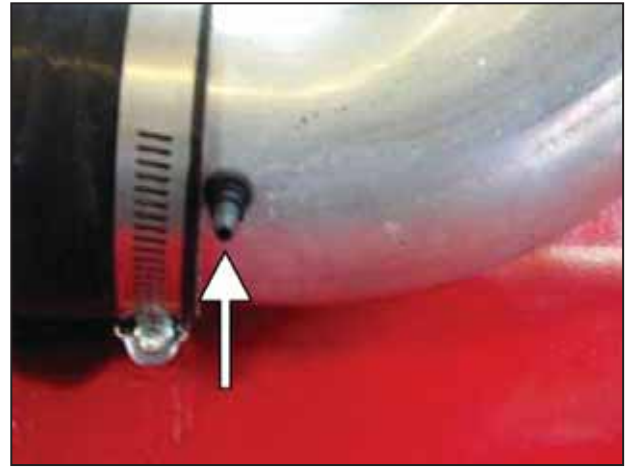

e. Insert vacuum adapter into the rubber grommet.



f. Trim hose to 1.5". Attach blow off valve (BOV) hose to inlet pipe and rotate as necessary for proper fit. Secure with hose clamp.



g. Insert BOV outlet into the BOV hose. Make sure you rotate the BOV toward the firewall, so that it clears the coolant hose.



h. Locate the crankcase breather hose.



i. Secure the factory breather hose to the nipple with the provided hose clamp.



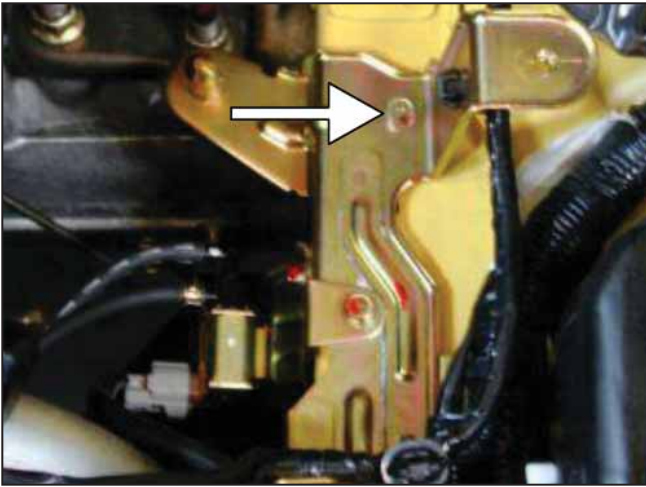

j. Replace this bolt with the rubber mount.



k. Attach vacuum line from the boost solenoid to the vacuum nipple underside of the pipe.



l. Assemble the MAF sensor adapter to the MAF sensor with the provided M6 nuts and M6 bolts.



m. Attach the filter element to the MAF sensor and secure with provided hose clamp.



n. Attach the coupler to the MAF sensor. Attach the provided hose clamps to the coupler as shown. Do not fully tighten. You may need to add a very small amount of lubricant to slide the coupler over the sensor for easier installation.



o. Attach the air filter and MAF sensor assembly to the inlet pipe. Line up the bracket to the rubber mount. Refer to the diagram on the next page.

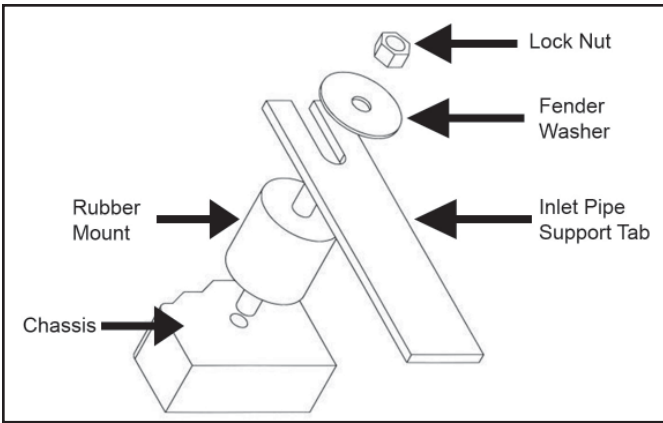

Proper rubber mount installation.

p. Reattach MAF sensor harness. Some vehicles may require that you remove approximately 2" of wire loom tape to create more slack to route the MAF harness.

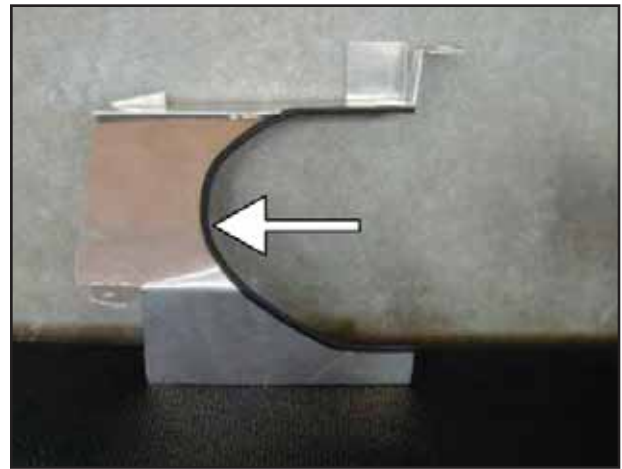
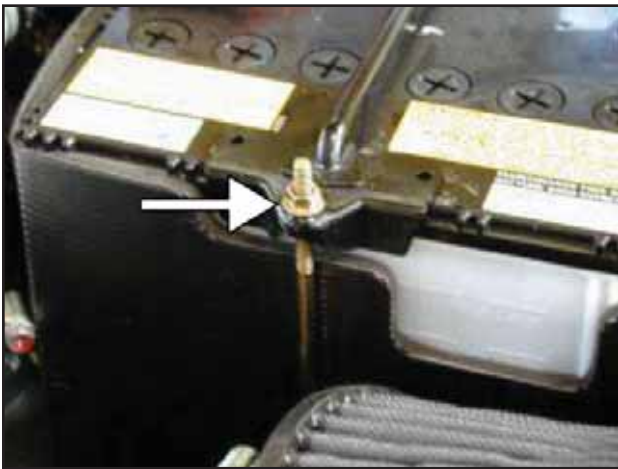

p. Unbolt nut to the battery bracket.

q. Attach the rubber edge trim to the heat shield.



r. Insert heat shield. Align with the battery bracket and secure with a washer and factory nut. Secure the other mounting point of the heat shield with the provided bolt.

s. Re-attach the factory inlet scoop and secure with the original push-in tabs.



#### **4. Reassemble Vehicle**

- a. Position the inlet pipes for the best fitment. Be sure that the pipes or any other components do not contact any part of the vehicle. Tighten the rubber mount, all bolts, and hose clamps.
- b. Check for proper hood clearance. Re-adjust pipes if necessary and re-tighten them.
- c. Inspect the engine bay for any loose tools and check that all fasteners that were moved or removed are properly tightened.
- d. Reconnect negative battery terminals and start engine. Let the vehicle idle for 3 minutes. Perform a final inspection before driving the vehicle.

#### **5. CARB Sticker Placement**

- a. The C.A.R.B. exemption sticker, (attached), must be visible under the hood so that an emissions inspector can see it when the vehicle is required to be tested for emissions. California requires testing every two years, other state may vary.

#### **6. Service and Maintenance**

- a. It is recommended that you service your AEM® Dryflow™ filter every 20,000 miles for optimum performance. Use AEM Dryflow cleaning kit part # 21-110.
- b. Use aluminum polish to clean your polished AEM® intake tube.
- c. Use window cleaner to clean your powder coated AEM® intake tube. **(NOTE: DO NOT USE aluminum polish on powder coated AEM intake tubes).**