



Equipped with AEM® Dryflow™ Filter
No Oil Required!

INSTALLATION INSTRUCTIONS

PART NUMBER: 22-425

2004-2005	DODGE Neon SRT-4 L4 2.4L	SEE *NOTE
2003	DODGE Neon SRT-4 L4 2.4L	C.A.R.B. E.O. # D-392-21

PARTS LIST

Description	Qty.	Part Number
Element Parts Kit 3.00 X 5" Dry Ele.	1	21-203DD
Short Pipe, Neon Turbo	1	2-4251
Elbow, 3.00/2.362 90 Deg.	1	5-303
Mount, Rubber 1" X 6mm	1	1228599
Grommet, 1/2"	1	784634
Neoprene, 1/16" X 4" X 3" Adhes.	1	8-126-3
Hose; 3/8"ID X 8"L	1	5-1008
Hose; 1/2"ID X 2"L	1	5-5002
Connector, Plastic 3/8" Straight.	1	8-125
Bracket	1	7-7246
Bolt, Hex/Flange M6-1 X 20	2	1-2038
Washer, M6 X 12mm OD SS	2	1-3016
Washer, 6mm Soft Mount	1	559999
Nut, M6 Hex Serrated	3	444.460.04
Hose Clamp, 3/4"	2	4093-5
1/2' Bnd. Hose Clamp, 2.15-3.00"	1	9440
1/2" Bnd. Hose Clamp, 2.56"-3.50"	1	9448
Hose Clamp, 1"	2	99024.032
1/2" Bnd. Hose Clamp, 2.90"-3.75"	1	9452

Read and understand these instructions **BEFORE** attempting to install this product. Failure to follow installation instructions and not using the provided hardware may damage the intake tube, throttle body and engine.

1. Preparing Vehicle

- a. Make sure vehicle is parked on level surface.
- b. Set parking brake.
- c. If engine has run in the past two hours, let it cool down.
- d. Disconnect negative battery terminal.
- e. Do not discard stock components after removal of the factory system.

2. Removal of stock system

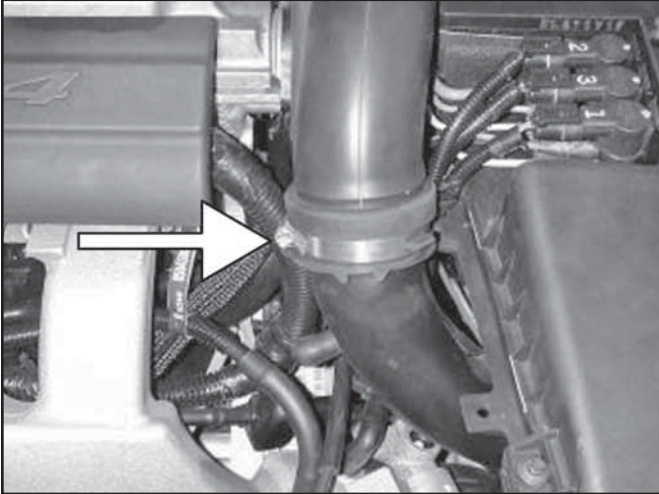

a. Loosen hose clamp near the air box.

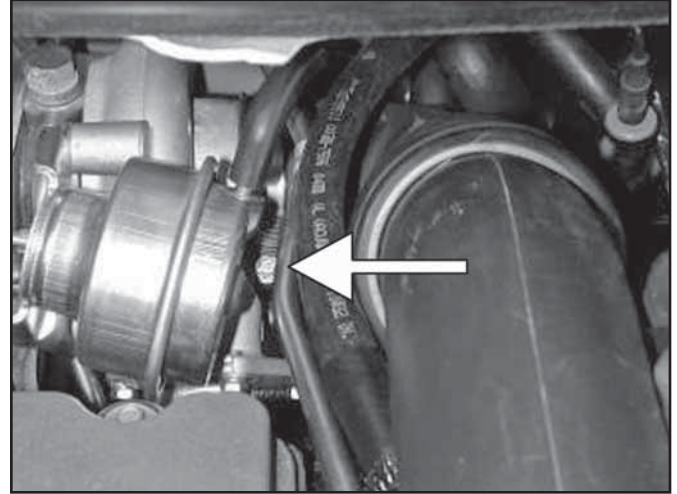

b. Loosen hose clamp at the turbo inlet.

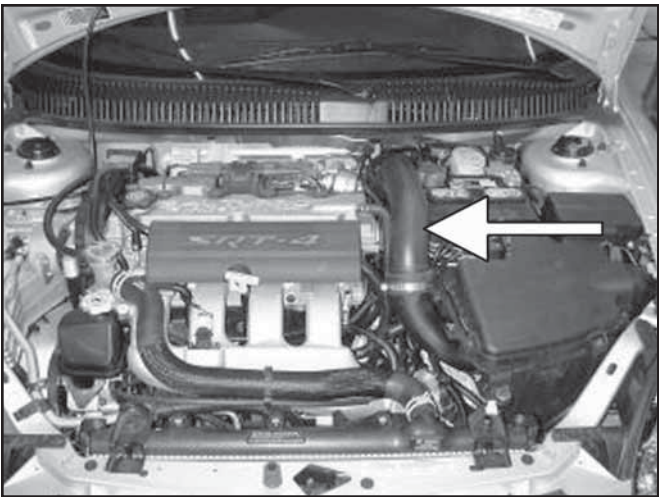

c. Remove the inlet air tube to the turbo.

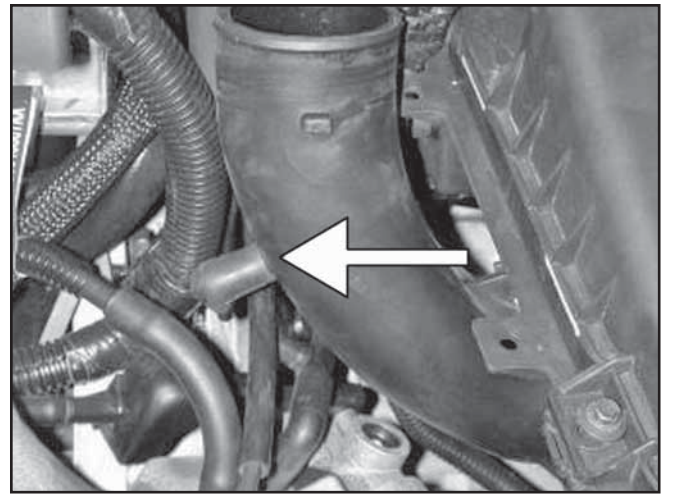

d. Unplug vacuum cap at the base of the air box.

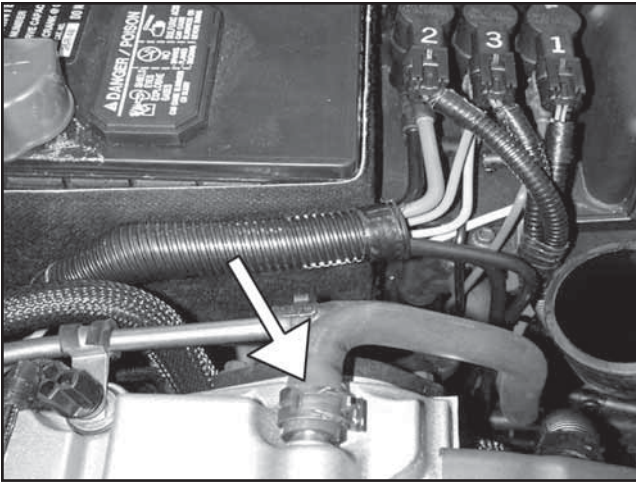

e. Remove the breather hose going to the air box. Check for oil. If present, clean as necessary.

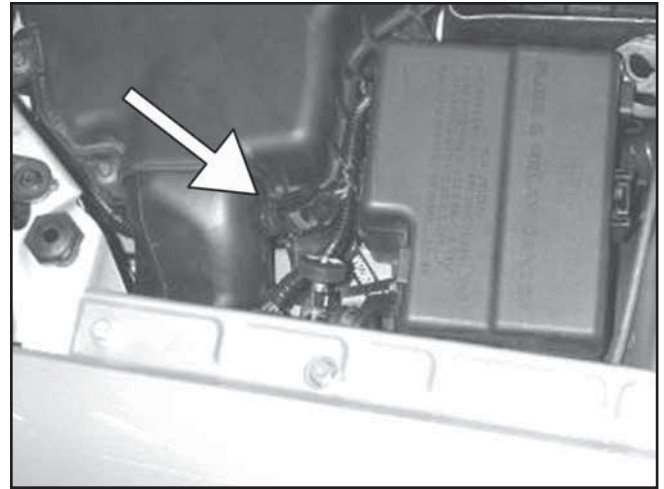

f. Remove IAT sensor from the air box.

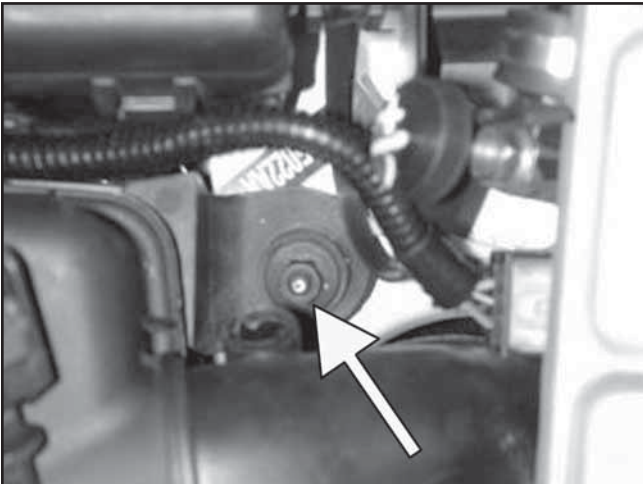

g. Loosen and remove nut holding down the air box. This nut is located by the vacant hole left by the IAT sensor.

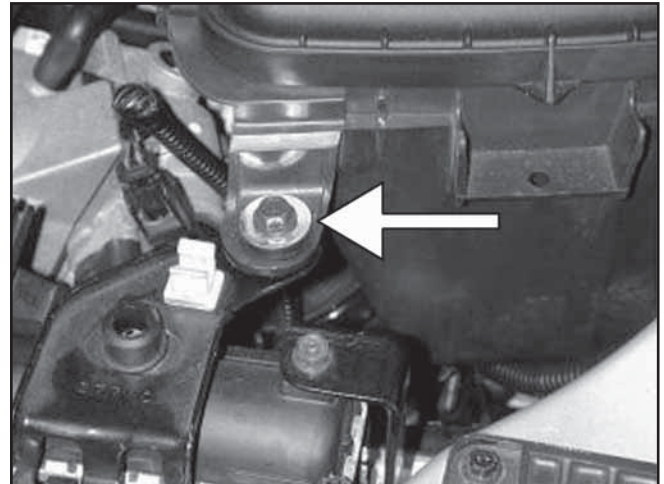

h. Remove bolt holding down the air box to the radiator support.

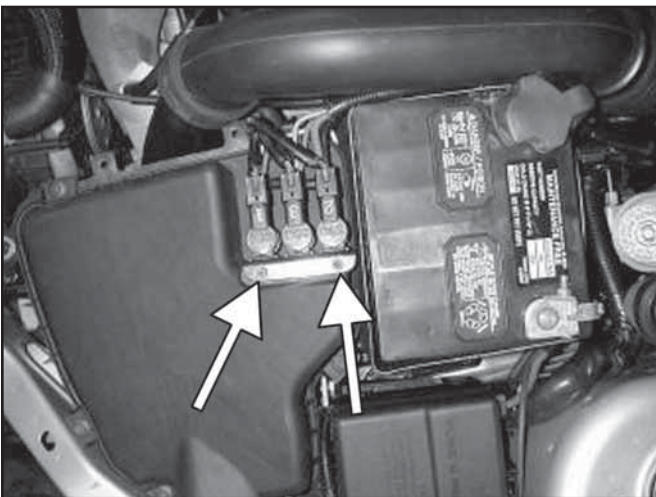

i. Remove the 2 bolts holding down the vacuum assembly to the air box.

3. Installation of AEM® intake system.

- a. When installing the intake system, do not completely tighten the hose clamps or mounting hardware until instructed to do so.

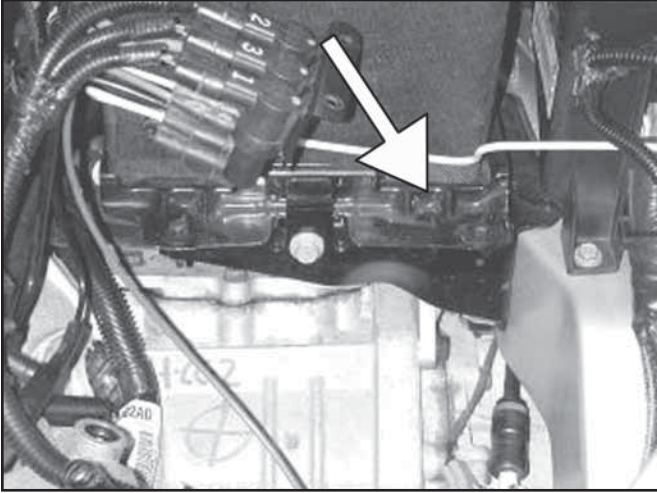

- b. Loosen and remove the bolt on the right side of the battery bracket.

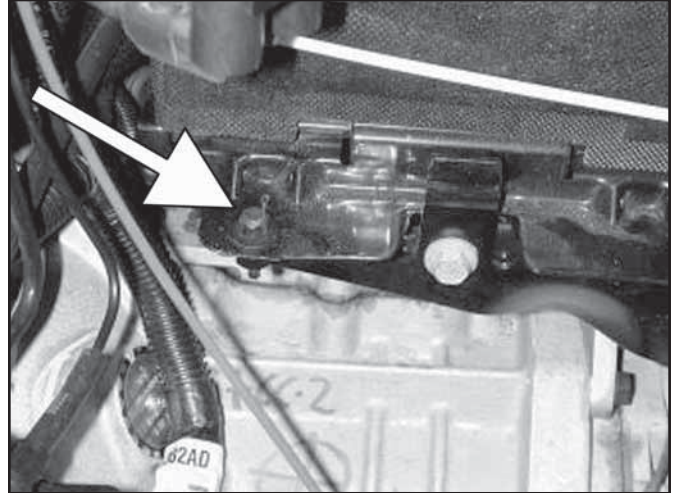

- c. Loosen the bolt on the left side of the battery bracket.

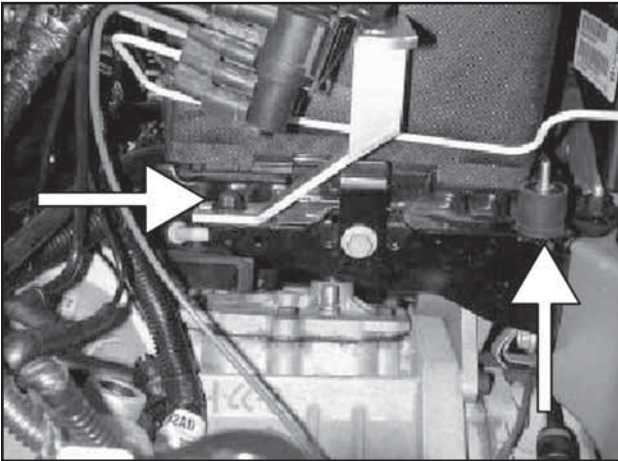

- d. Insert rubber mount on the right side of the battery bracket. Attach the vacuum assembly bracket to the left side as shown. Secure the vacuum assembly bracket to the battery bracket.

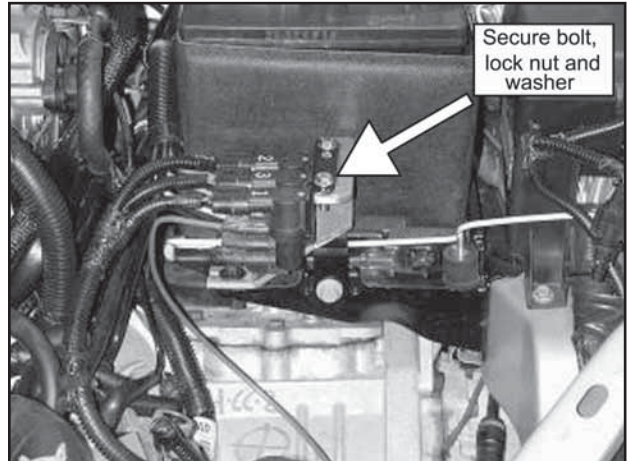

- e. Secure the vacuum assembly to the vacuum assembly bracket. Make sure all the hard vacuum lines are clear of any obstruction.



f. Attach the 3" side of the silicon elbow to the inlet pipe. Secure elbow to the inlet pipe. The open end connects to the turbo inlet which sits horizontal.



g. Attach the other end of the silicon coupler to the turbo inlet. Line up the bracket on the inlet pipe to the rubber mount. Secure the hose clamp.

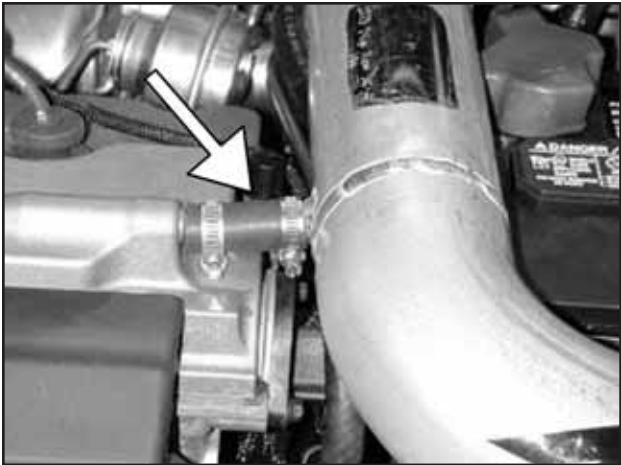

h. Attach breather hose from the crankcase to the inlet pipe. Secure with provided hose clamps. Make sure the nipple on the valve cover and pipe are fully inserted into the hose.



i. Make sure neoprene rubber adhesive clears the positive battery terminal. Make sure the (+) post protector on the battery is not damaged, cracked or melted. If any of the conditions exist, you must replace before completing the installation of the AEM® intake system. Failure to not follow these instructions will void warranty.

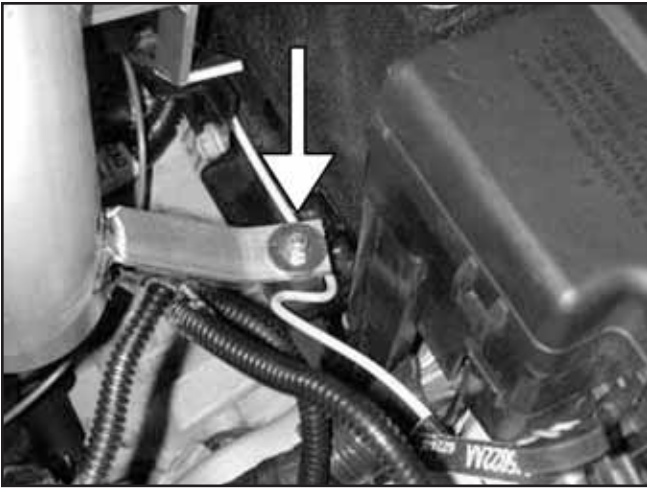

j. Secure the bracket of the inlet pipe to the rubber mount. Refer to the diagram below.

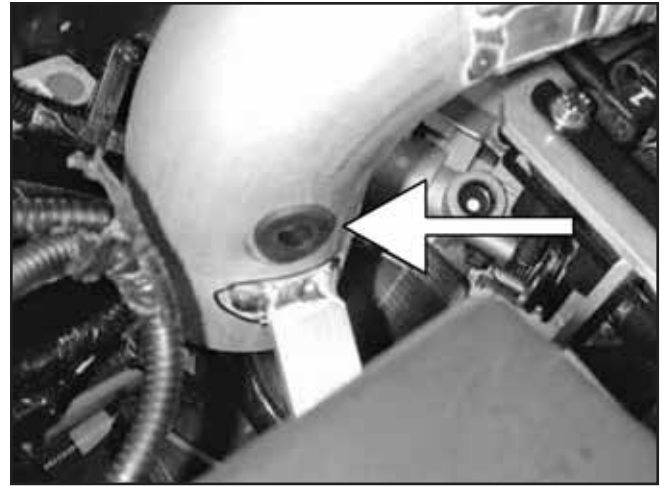
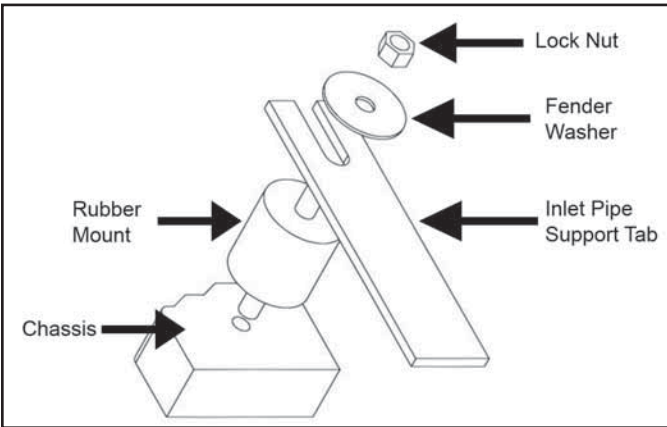

k. Insert rubber grommet into $\frac{3}{4}$ " hole.



l. Reinsert IAT sensor into the rubber grommet.

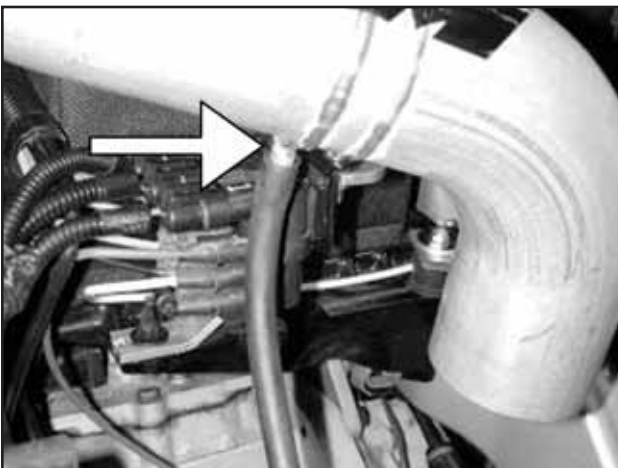

m. Attach vacuum hose to the breather nipple on the underside of the pipe and secure with hose clamp.



n. Attach vacuum fitting to the other end of the vacuum line.



o. Insert vacuum fitting into the vacuum cap left from the installation Step 2d.



p. Attach filter element. Secure with provided hose clamp.

4. Reassemble Vehicle

- a. Position the inlet pipes for the best fitment. Be sure that the pipes or any other components do not contact any part of the vehicle. Tighten the rubber mount, all bolts, and hose clamps.
- b. Check for proper hood clearance. Re-adjust pipes if necessary and re-tighten them.
- c. Inspect the engine bay for any loose tools and check that all fasteners that were moved or removed are properly tightened.
- d. Reconnect negative battery terminals and start engine. Let the vehicle idle for 3 minutes. Perform a final inspection before driving the vehicle.

5. CARB Sticker Placement

- a. The C.A.R.B. exemption sticker, (attached), must be visible under the hood so that an emissions inspector can see it when the vehicle is required to be tested for emissions. California requires testing every two years, other states may vary.

6. Service and Maintenance

- a. It is recommended that you service your AEM® Dryflow™ filter every 20,000 miles for optimum performance. Use AEM Dryflow cleaning kit part # 21-110.
- b. Use aluminum polish to clean your polished AEM® intake tube.
- c. Use window cleaner to clean your powder coated AEM® intake tube. **(NOTE: DO NOT USE aluminum polish on powder coated AEM intake tubes).**