



Equipped with AEM® *Dryflow™* Filter
No Oil Required!

INSTALLATION INSTRUCTIONS

PART NUMBER: 21-9210

1994-2002	DODGE	Ram 2500 Pickup	L6-5.9L DSL	C.A.R.B. E.O. # D-670
1994-2002	DODGE	Ram 3500 Pickup	L6-5.9L DSL	C.A.R.B. E.O. # D-670

PARTS LIST

	Description	Qty.	Part Number
A	Element Parts Kit 4.00x 9" DSL Oval Dry	1	21-2259DK
B	Inlet Pipe	1	2-82101
C	Heat Shield	1	20-8210
D	Elbow, 4.00 Tight 90 Deg.	1	5-490
E	Edge Trim, 30"	1	8-4030
F	Insert, Diesel A/F Assy. 4"	1	5-2259
G	Grommet, 1/2" 3/32 GW	1	784646
H	Mount, Rubber 1" X 8mm	2	1228560
I	Rubber Edge Trim 16"	1	8-3016
J	Zip Tie, 8" Tree Push-Mnt.	2	1-127
K	Washer; 1"D X 1/4 Hole Fender	3	08160
L	Washer, 8mm Soft Mount	4	559960
M	Nut, M6 Hex Serrated	3	444.460.04
N	Nut, M8 Hex Serrated	4	444.460.08
O	1/2" Bnd. Hose Clamp, 3.56"-4.50"	3	9464

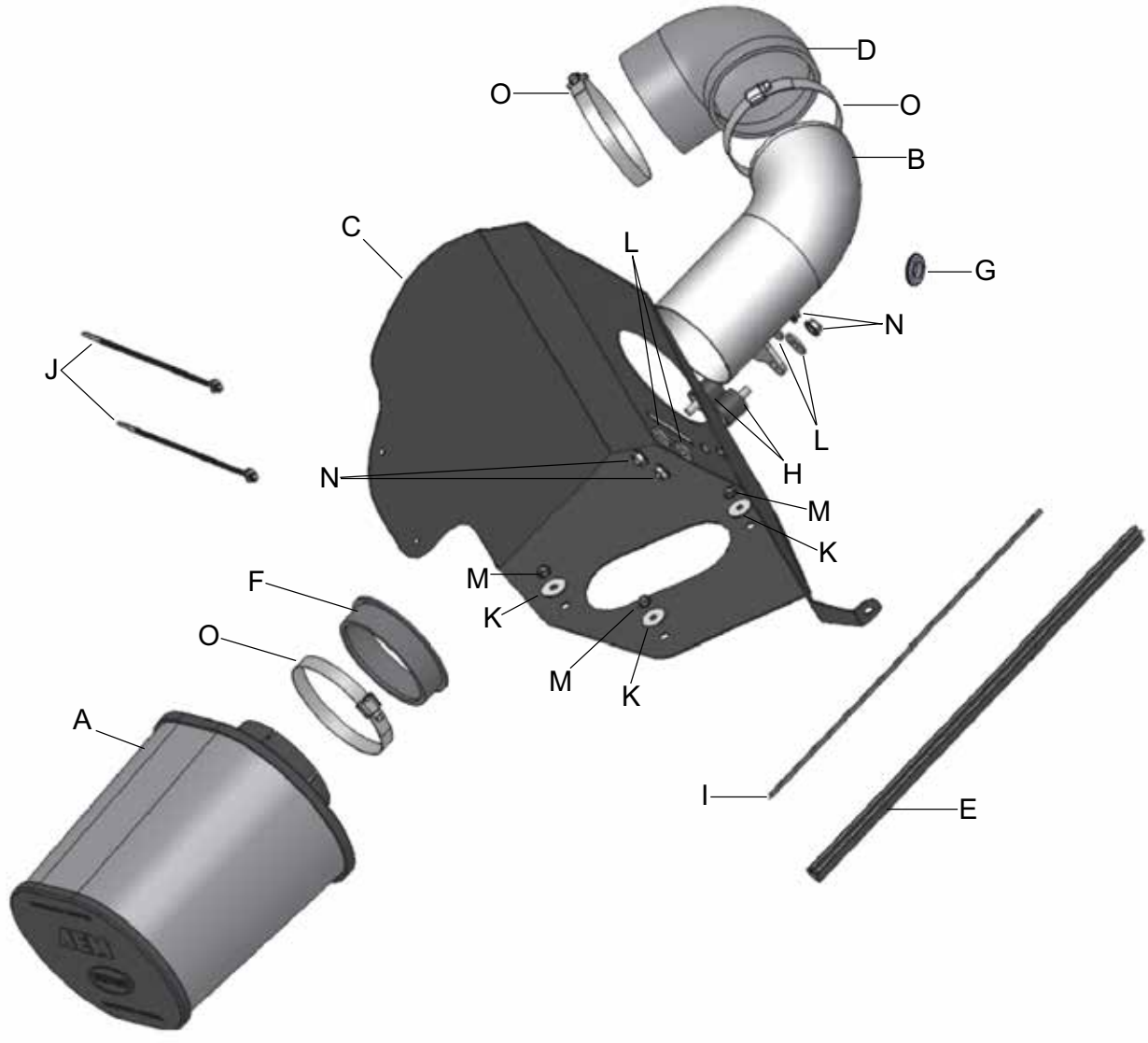

Read and understand these instructions **BEFORE** attempting to install this product. Failure to follow installation instructions and not using the provided hardware may damage the intake tube, throttle body and engine.

1. Preparing Vehicle

- a. Make sure vehicle is parked on level surface.
- b. Set parking brake.
- c. If engine has run in the past two hours, let it cool down.
- d. Disconnect the negative battery terminal.
- e. Do not discard stock components after removal of the factory system.

2. Removal of stock system



a. Factory air box system



b. Loosen the hose clamps securing the flexible inlet hose between the turbo inlet and the air filter housing. Remove the flexible inlet hose.



c. Release the four retaining clips securing the air filter housing lid to the lower housing. Remove the air filter housing lid.



d. Remove the snorkel from the lower air filter housing by squeezing the middle together while pulling towards the center of the vehicle.



e. Loosen the three plastic nuts securing the lower air filter housing to the vehicle. Remove the housing by gently lifting up.

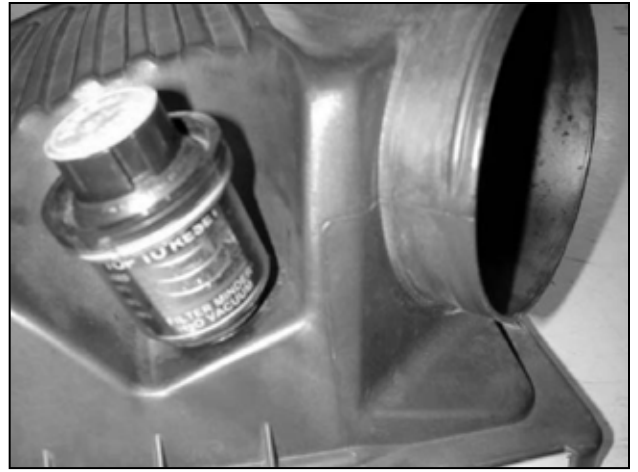

f. Remove the factory air filter restriction gauge from the stock air filter housing lid. Set aside for use during the AEM® intake kit installation.

3. Installation of AEM® intake system.

- a. When installing the intake system, do not completely tighten the hose clamps or mounting hardware until instructed to do so.
- b. Before installing the intake pipe, be sure to check for packaging material in the intake pipe.



c. Stock air box system removed.



d. Remove the 13mm bolt from the inner fender behind the passenger side battery as shown.



e. Install the two supplied tree mount zip-ties into the two holes on heat shield as shown.



f. Install the supplied rubber edge trim to the hole on the heat shield. Trim to fit.



g. Install the two rubber mounts into the slot on the heat shield using the supplied M8 washers and nuts. Do not tighten the nuts.

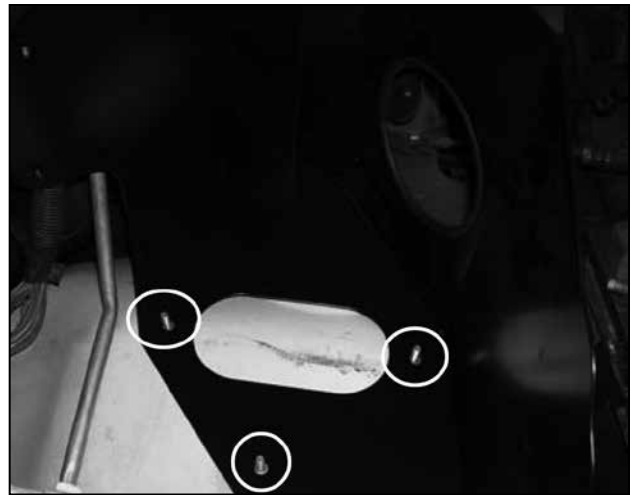

h. Carefully place the heat shield in the engine compartment aligning the three holes on the bottom with the studs in the inner fender.

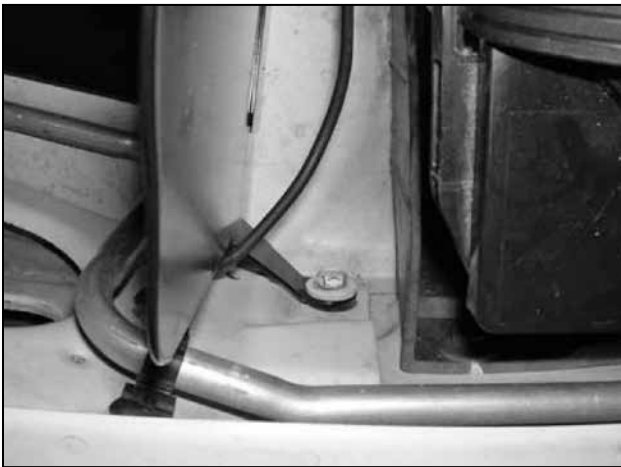

i. Align the small mounting tab with the bolt hole exposed during step 3d. Using the bolt removed in step 3d, secure the heat shield tab to the inner fender.

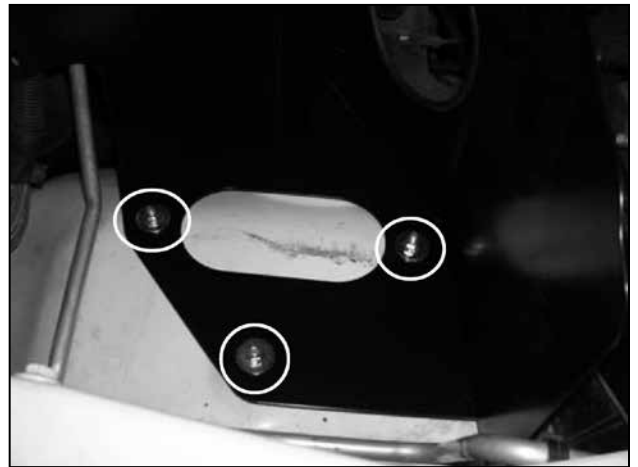

j. Install the three supplied M6 nuts and washers onto the studs from step 3h. Once the heat shield is properly aligned, fully tighten the nuts and the bolt from step 3i.

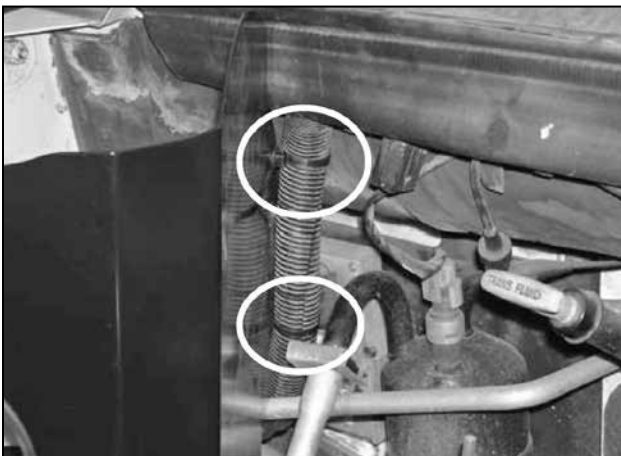

k. Secure the two previously installed zip-ties to the main wiring harness by the vehicle firewall. Trim the excess plastic.



l. Loosely install the 90° coupler onto the short end of the intake pipe as shown. Attach a #64 hose clamp, but do not tighten the hose clamp.



m. Install the grommet (784646) onto the intake pipe (use soapy water to aid installation). Place the grommet into the pipe at an angle and rotate it until the groove engages the pipe. Insert the filter minder gauge into the grommet.



n. Install the intake pipe by sliding the long end of the coupler over the turbo inlet while aligning the mounting bracket of the intake pipe with the two rubber mounts attached to the heat shield.

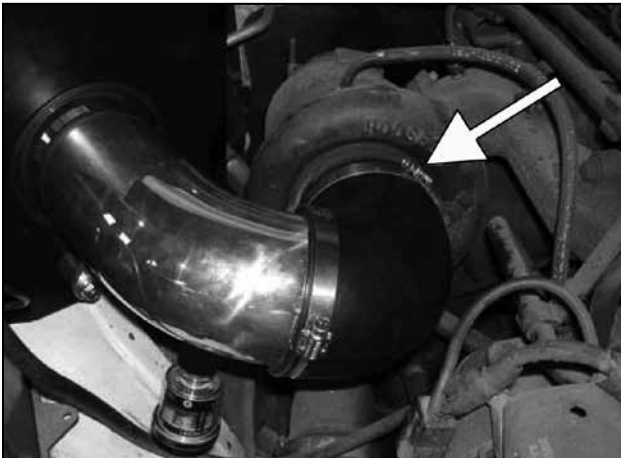

o. Secure the coupler to the turbocharger using a #64 hose clamp; secure but do not fully tighten the hose clamp.



p. Secure the intake pipe mounting bracket to the heat shield using the supplied M8 washers and nuts.



q. Install the supplied air filter adapter by stretching it over the end of the intake pipe.



r. Ensure the intake pipe is centered in the heat shield hole. Once properly aligned, completely tighten the nuts on the intake pipe bracket and the hose clamps securing the intake pipe.



s. Slide the hose clamp onto the air filter's neck and attach the air filter assembly onto the filter adapter. Ensure the air filter is completely seated onto the adapter and the hose clamp is aligned with the filter adapter's lip. Once the hose clamp is properly aligned, secure the hose clamp, ensuring the filter neck's tabs compress and engage the filter adapter. Ensure the air filter does not make contact with any part of the vehicle and has adequate clearance.



Factory air box installed



AEM® intake system installed

4. Reassemble Vehicle

- a. Position the inlet pipes for the best fitment. Be sure that the pipes or any other components do not contact any part of the vehicle. Tighten the rubber mount, all bolts, and hose clamps.
- b. Install the rubber gasket onto the top edge of the heat shield and trim the excess. This seals the hood to the heat shield. Check for proper hood clearance. Re-adjust pipes if necessary and re-tighten them.
- c. Inspect the engine bay for any loose tools and check that all fasteners that were moved or removed are properly tightened.
- d. Reconnect the negative battery terminal and start engine. Let the vehicle idle for 3 minutes. Perform a final inspection before driving the vehicle.

5. CARB Sticker Placement

- a. The C.A.R.B. exemption sticker, (attached), must be visible under the hood so that an emissions inspector can see it when the vehicle is required to be tested for emissions. California requires testing every two years, other states may vary.

6. Service and Maintenance

- a. AEM Induction Systems requires cleaning the intake system's air filter element every 100,000 miles. When used in dusty or off-road environments, our filters will require cleaning more often. We recommend that you visually inspect your filter once every 25,000 miles to determine if the screen is still visible. When the screen is no longer visible some place on the filter element, it is time to clean it. To clean, purchase our Synthetic air filter cleaner, part number 99-0624 and follow the easy instructions.
- b. Use window cleaner to clean your powder coated AEM® intake tube.

NOTE: DO NOT USE aluminum polish on powder coated AEM® intake tubes.