



Equipped with AEM® *Dryflow™ Filter*  
No Oil Required!

# INSTALLATION INSTRUCTIONS

## PART NUMBER: 21-548

---

2003-2006 INFINITI G35 V6-3.5L

C.A.R.B. E.O. # D-670-2

## PARTS LIST

Description	Qty.	Part Number
Air Filter Assy. 3.00 X 5" Dry Ele.	1	21-203DK
Upper Pipe	1	2-548
Lower Pipe	1	2-549
Adaptor, MAF	1	2-641
Hose, Silicone 3.00x3" Blk.	2	5-300
Hose, Adapter 3.25/3.00 X 2.25"	1	5-323
Mount, Rubber 1" X 6mm	1	1228599
Bolt, Hex M6 X 1.0 X 16mm	4	1-2030
Washer, M6 X 12mm OD Zinc	4	1-3018
Washer, 6mm Soft Mount	1	08160
Nut, M6 Hex Serrated	1	444.460.04
1/2" Bnd. Hose Clamp, 2.56"-3.50"	5	9448
1/2" Bnd. Hose Clamp, 2.90"-3.75"	2	9452

Read and understand these instructions **BEFORE** attempting to install this product. Failure to follow installation instructions and not using the provided hardware may damage the intake tube, throttle body and engine.

## 1. Preparing Vehicle

- a. Make sure vehicle is parked on level surface.
- b. Set parking brake.
- c. If engine has run in the past two hours, let it cool down.
- d. Disconnect all negative battery terminals.
- e. Raise the front of the vehicle with a jack. Refer to your owner's manual for proper jack and jack stand placement to properly support vehicle. Support your vehicle using properly rated jack stands before wheel removal or while working under the vehicle.

**NEVER WORK UNDER A VEHICLE WITHOUT USING JACK STANDS.**

- i. Remove the driver side wheel.
- f. Do not discard stock components after removal of the factory system.

## 2. Removal of stock system

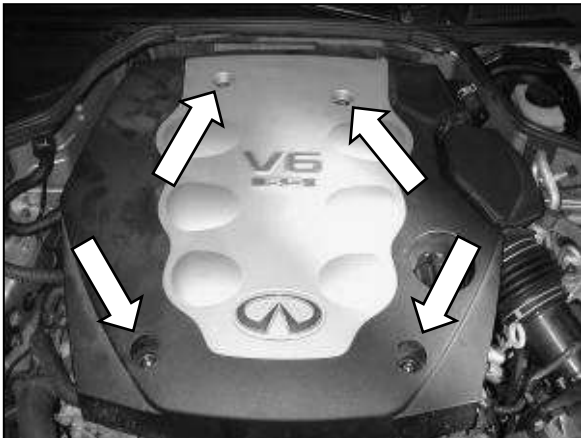

a. Remove the four fasteners holding on the engine cover. Remove the engine cover.

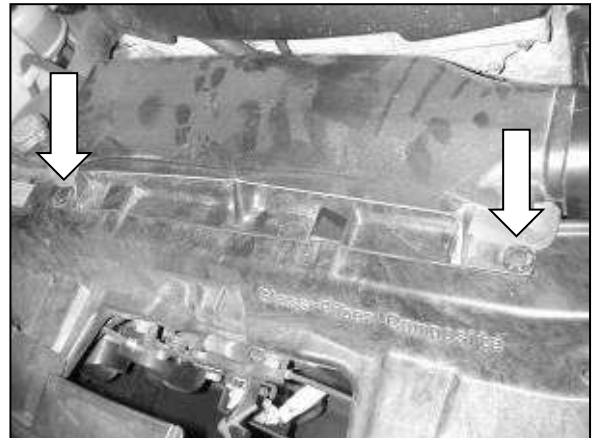

b. Remove the two plastic fasteners holding on the air duct and remove the duct from the engine bay.

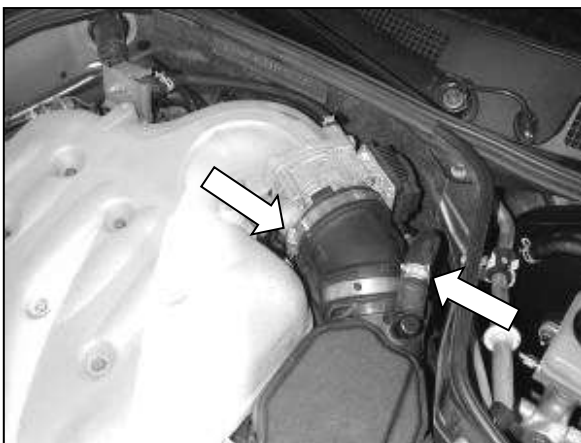

c. Loosen the hose clamp holding the stock intake tube on the throttle body. Loosen the spring hose clamp on the breather hose and pull the hose off of the fitting on the intake tube.

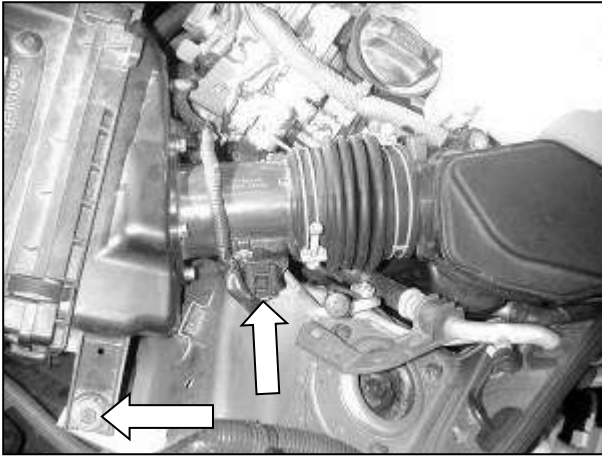

d. Remove the bolt holding the factory air box in place. Unplug the Mass Air Flow (MAF) sensor and unplug the wiring loom from the intake system.



e. Pull directly upward on the air box to unplug it from the mounts. Remove the complete air box system from the vehicle.

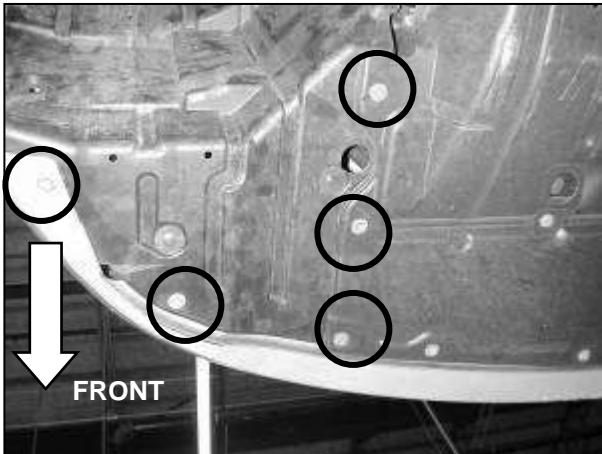

f. From underneath the car, remove the bolts circled in the picture.



g. From inside the wheel well, remove the two plastic fasteners shown in the picture.



h. Peel back the splash guard and tuck it out of the way. Remove the lower resonant chamber circled in the picture.

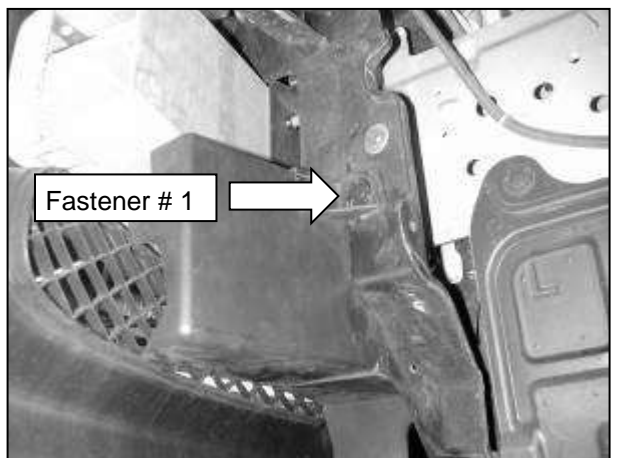

i. Remove the air duct shown by removing the three plastic fasteners holding it in place. (See next page)

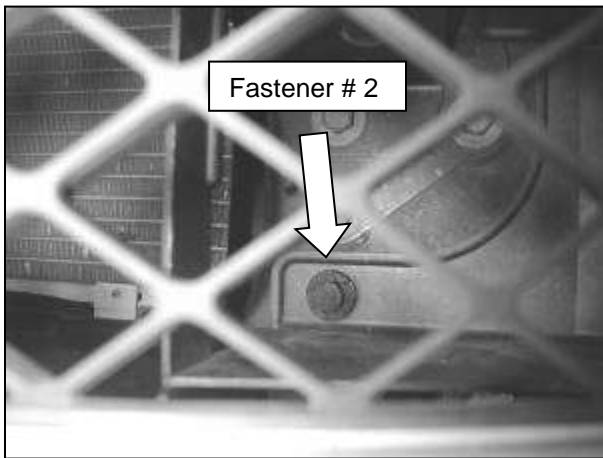

View through grille.

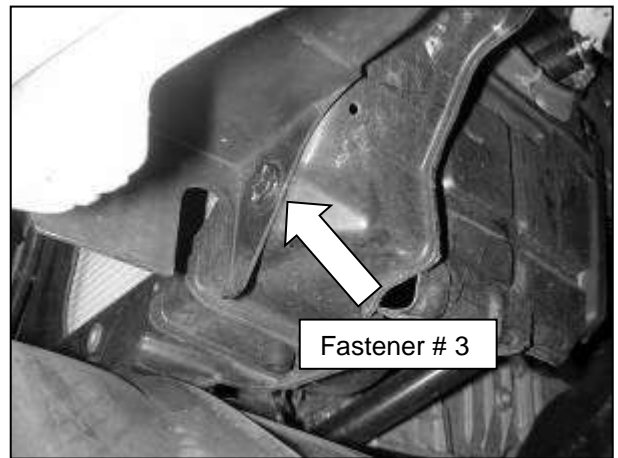

View from underneath.

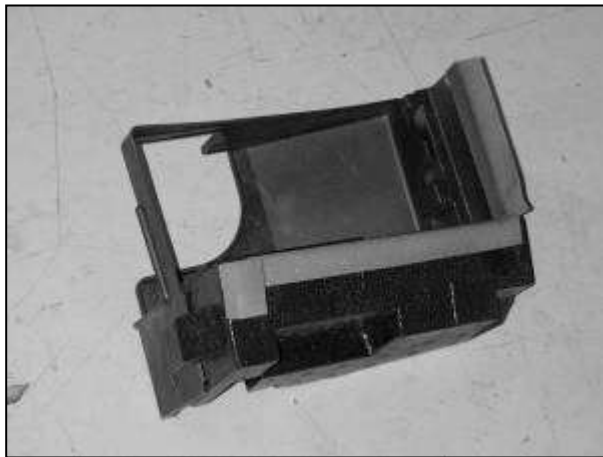

**NOTE:** The G35 sedan has foam insert attached to the plastic duct. Remove the whole assembly.

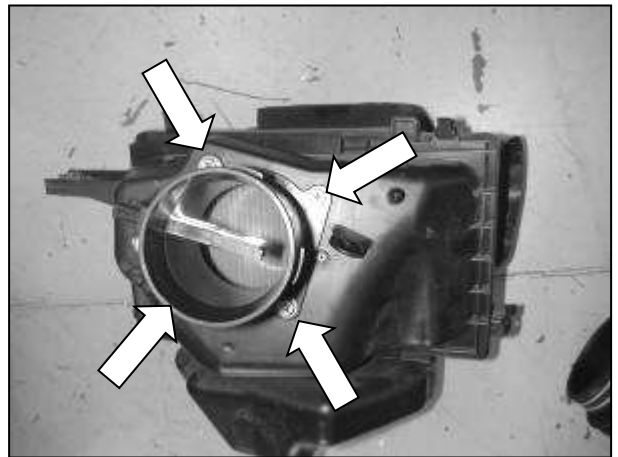

j. Remove the four bolts holding the MAF sensor on the factory air box. Handle the MAF sensor with care.

### 3. Installation of AEM® intake system.

- a. When installing the intake system, do not completely tighten the hose clamps or mounting hardware until instructed to do so.



b. Using the 6mm bolts and washers included in the kit, bolt the MAF sensor to the AEM® adaptor.



c. Slide one of the 3" straight silicone couplers over the MAF sensor as shown. Lightly oiling the inside of the coupler may help. Secure the coupler in place using a #48 hose clamp.



d. Place the 3.25"-3.0" reducing silicone coupler on the throttle body. Use a #52 hose clamp around the throttle body. Make sure the coupler is sitting squarely on the throttle body and tighten the #52 hose clamp. Loosely install a #48 hose clamp on the other end of the coupler.



e. Insert the upper intake pipe in the coupler as shown. Reuse the factory hose clamp and install the breather hose on the fitting on the pipe. Do not tighten the #48 hose clamp.



f. Install the assembly from step 3c on the upper intake pipe. Loosely install a #48 hose clamp on the coupler. Make sure the MAF sensor connector is pointing toward the oil cap.



g. Install the other 3" silicone coupler on the end of the AEM<sup>®</sup> MAF adaptor. Loosely install two #48 hose clamps.

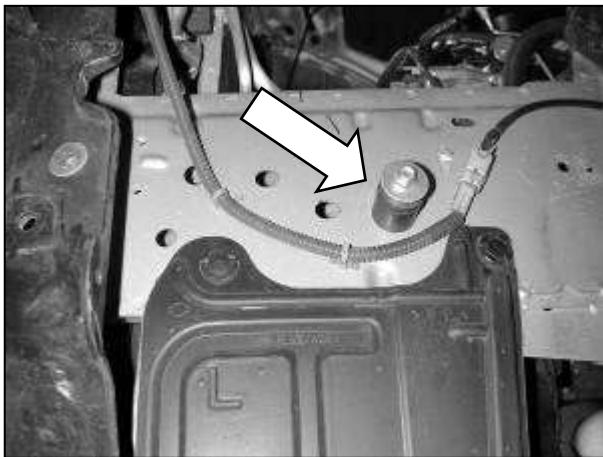

h. Thread the rubber mount into the hole that held the resonant chamber rear mounting bolt. Hand tighten the rubber mount.



i. If installing on a G35 Sedan, remove the mounting screw for the HID headlight controller.  
**NOTE: For G35 Coupe models ignore steps 3i.-3i. and proceed to step 3k.**

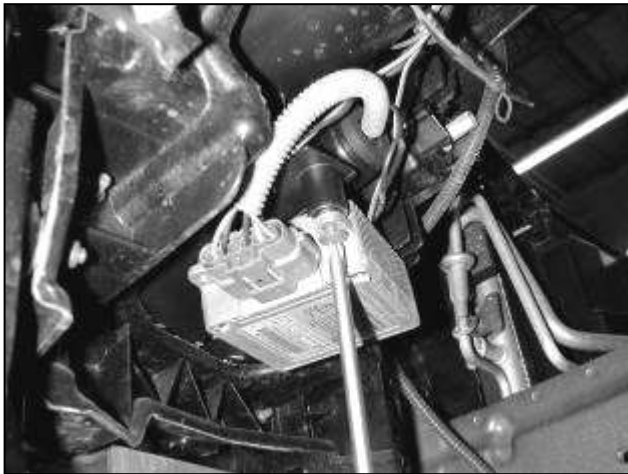

j. Rotate the HID controller forward and reinstall the screw in the other mounting hole on the controller. Pull excess slack for the wires from farther up the harness if needed.



k. Install the lower intake pipe in the end of the coupler on the AEM® MAF adaptor. Line up the bracket on the pipe with the rubber mount and install the 6mm nylock nut and fender washer (See diagram below). Do not completely tighten.



l. Install the AEM® air filter onto the end of the lower intake pipe. Make sure the air filter is fully and squarely seated on the end of the pipe. Use a #52 hose clamp to secure it in place.

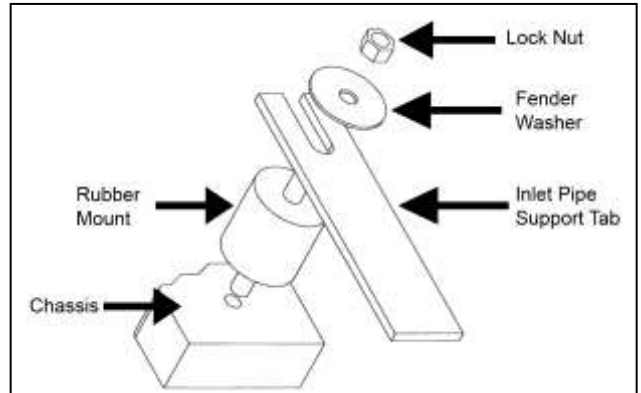

Proper installation of rubber mount assembly.



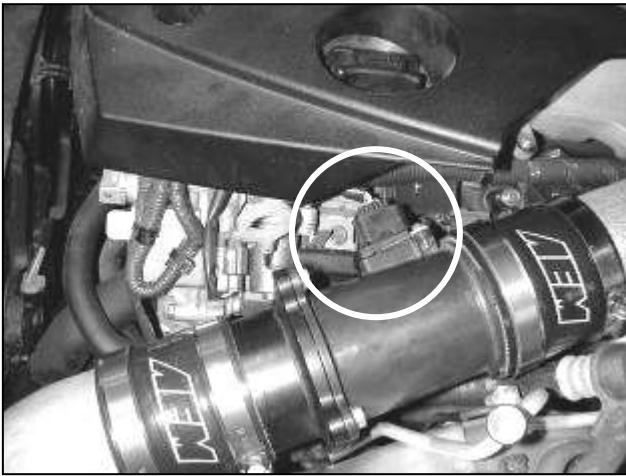

m. Plug in the MAF sensor. Place the engine cover on the intake manifold and check for clearance of the MAF sensor plug. Rotate the MAF sensor assembly until the plug has adequate clearance of the cover.



n. Check closely for clearance around the air filter and the AEM<sup>®</sup> MAF sensor adaptor, reposition as needed.

#### 4. Reassemble Vehicle

- a. **Engine Cover:** Install and secure the engine cover.
- b. **Fender liner and splashguard:** Install the fender liner, lower splash guard and any hardware that was removed in steps 2f through 2h.  
**NOTE: Failure to install the fender liner will result in diminished performance and increase the potential for engine damage due to water ingestion in rainy conditions.**
- c. **Wheel:** Install the driver's side wheel using the factory torque specification (see owner's manual).
- d. Position the inlet pipes for the best fitment. Be sure that the pipes or any other components do not contact any part of the vehicle. Tighten the rubber mount, all bolts, and hose clamps.
- e. Check for proper hood clearance. Re-adjust pipes if necessary and re-tighten them.
- f. Inspect the engine bay for any loose tools and check that all fasteners that were moved or removed are properly tightened.

- g. Reconnect negative battery terminals and start engine. Let the vehicle idle for 3 minutes. Perform a final inspection before driving the vehicle.

## 5. CARB Sticker Placement

- a. The C.A.R.B. exemption sticker, (attached), must be visible under the hood so that an emissions inspector can see it when the vehicle is required to be tested for emissions. California requires testing every two years, other states may vary.

## 6. Service and Maintenance

- a. It is recommended that you service your AEM® Dryflow™ filter every 20,000 miles for optimum performance. Use AEM Dryflow cleaning kit part # 21-110.
- b. Use aluminum polish to clean your polished AEM intake tube.
- c. Use window cleaner to clean your powder coated AEM intake tube. **(NOTE: DO NOT USE aluminum polish on powder coated AEM intake tubes)**