



Equipped with AEM® *Dryflow™ Filter*
No Oil Required!

INSTALLATION INSTRUCTIONS

PART NUMBER:

21-505B (Blue Finish)

21-505C (Gun Metal Grey Finish)

21-505R (Red Finish)

2002-2005 ACURA RSX L4-2.0L Manual Trans. C.A.R.B. E.O. # D-670-15

PARTS LIST

Description	Qty.	Part Number
Air Filter Assy. 2.75 X 5" Dry Ele.	1	21-202DK
Inlet Pipe	1	2-592
Washer Bottle, Acura RSX	1	9-506
Elbow, 2.75-90 3.4" & .9 w/Hole	1	5-280-H
Hose; 3/4"ID X 30"L	1	5-4030
Hose; 3/8"ID X 28"L	1	5-1028
Mount, Rubber 1" X 8mm	1	1228560
Zip Tie, 11.25 Long	1	1-115
Washer, 8mm Soft Mount	1	559960
Nut, M8 Hex Serrated	1	444.460.08
Hose Clamp, 3/4"	2	4093-5
Hose Clamp #12 Mini	2	08420
1/2" Bnd. Hose Clamp, 2.31-3.25"	2	9444
1/2" Bnd. Hose Clamp, 2.90"-3.75"	1	9452

Read and understand these instructions **BEFORE** attempting to install this product. Failure to follow installation instructions and not using the provided hardware may damage the intake tube, throttle body and engine.

1. Preparing Vehicle

- a. Make sure vehicle is parked on level surface.
- b. Set parking brake.
- c. If engine has run in the past two hours, let it cool down.
- d. Disconnect negative battery terminal.
- e. Raise the front of the vehicle with a jack. Refer to your owner's manual for proper jack and jack stand placement to properly support vehicle. Support your vehicle using properly rated jack stands before wheel removal or while working under the vehicle.

NEVER WORK UNDER A VEHICLE WITHOUT USING JACK STANDS.

- i. Remove the front left wheel.
 - ii. Remove the left fender well lining and lower splashguard.
- f. This intake system includes a replacement windshield washer system.
 - g. Do not discard stock components after removal of the factory system.

2. Removal of stock system



- a. Remove the two M6 bolts holding down the injector cover; remove the cover.

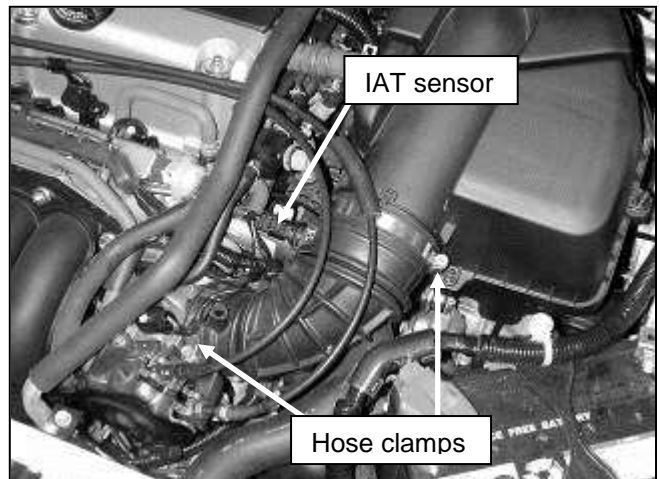

- b. Loosen the two hose clamps securing the stock inlet tube to the throttle body and filter box. Unplug the intake air temp (IAT) sensor and remove the stock inlet tube.

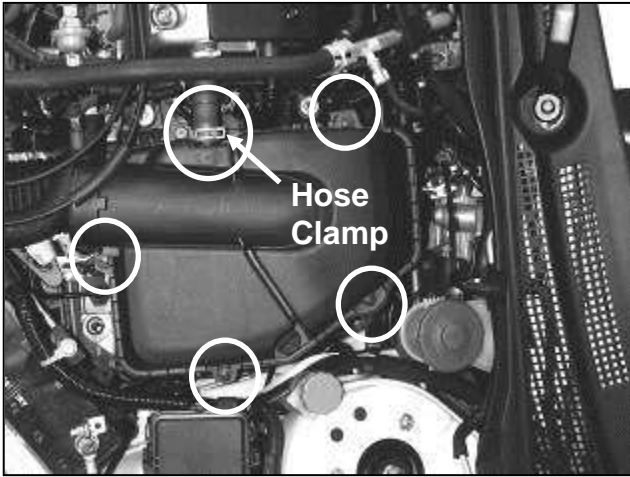

c. Loosen the 5 Phillips head screws and remove the air filter box cover. Also disconnect the breather hose by releasing the hose clamp.

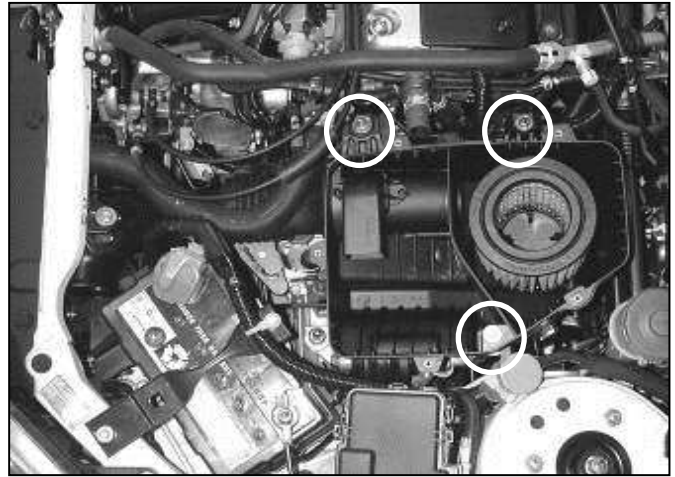

d. Loosen the two M6 bolts and the M6 nut securing the air filter box and remove it.

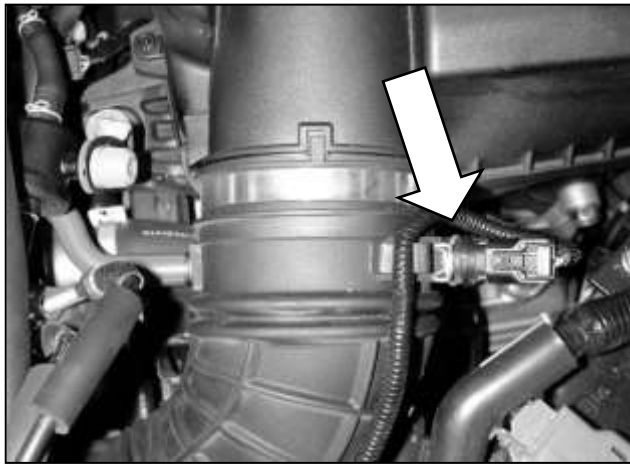

e. Remove the IAT sensor and the thermal valve hose from the inlet tube. Also, disconnect the thermal valve hose from the thermal valve. Finally, remove the inlet tube.

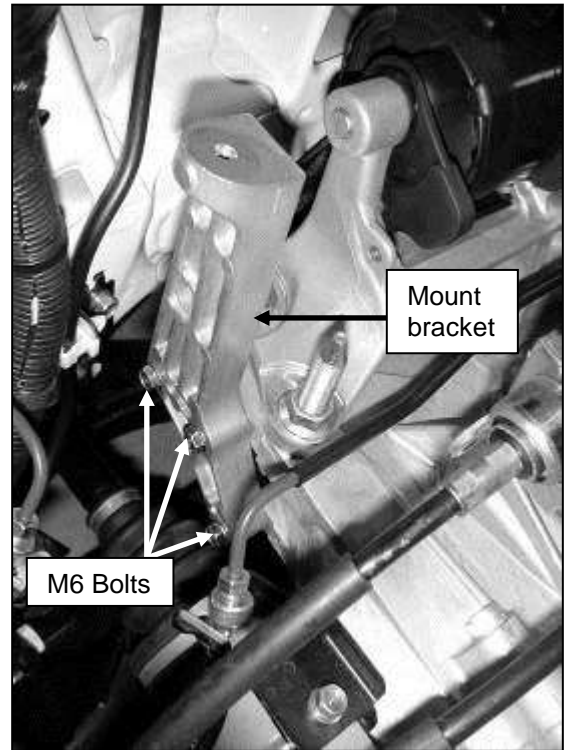

f. Remove the three M6 bolts that secure the air box support bracket and save them for later use. Remove the air filter box mount bracket.

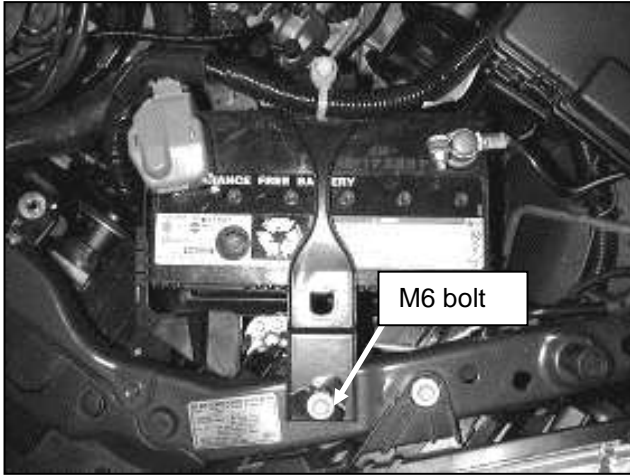

g. Remove the positive cable from the battery. Remove the M6 bolt securing the battery tie down in place. Remove the battery and trays.

3. Removal and replacement of the stock windshield washer bottle.

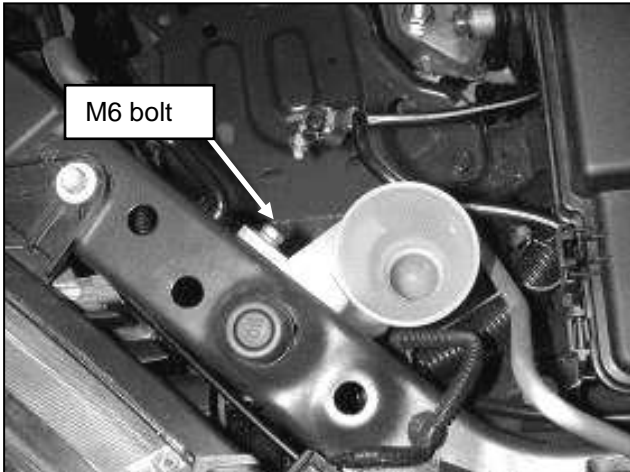

a. Remove the M6 bolt securing the washer bottle filler neck. Remove the washer bottle filler neck by pulling it up.

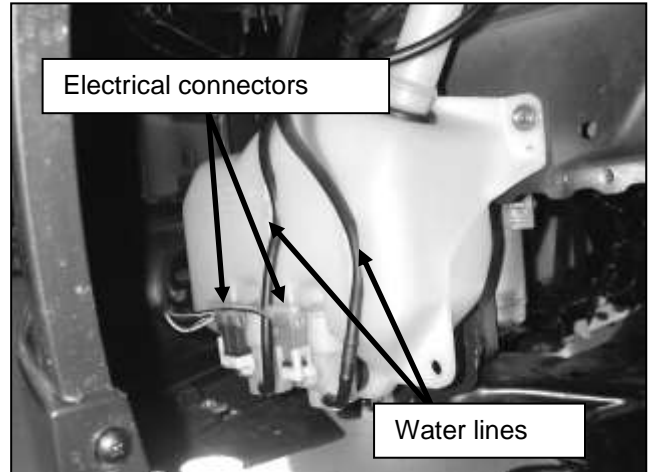

b. Remove the electrical connectors and water lines from the windshield wiper motors. Drain the washer bottle fluid into a clean container.

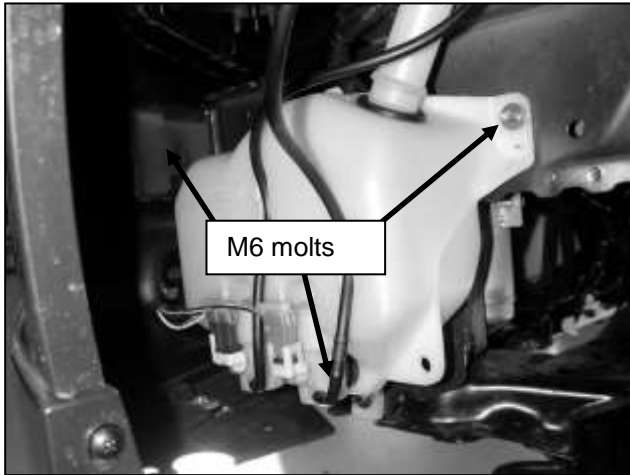

c. Remove the three M6 bolts securing the washer bottle in place. Pull the filler tube out of the bottle.

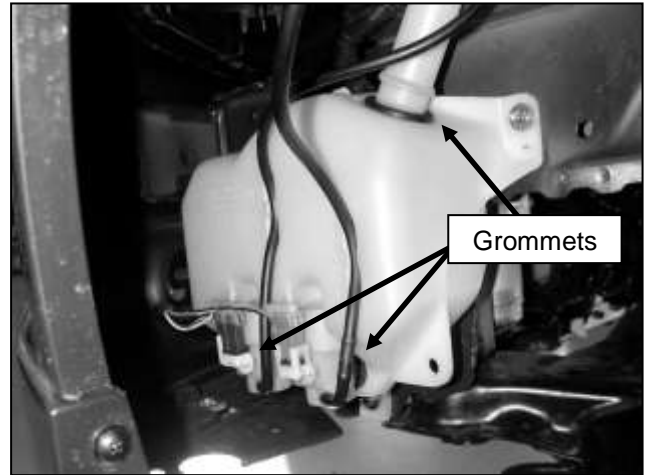

d. Remove the two pumps by pulling them from the rubber grommets. Remove the two grommets from the washer bottle along with the grommet for the filler tube.



e. Reinstall the two pump grommets and the fill tube grommet on the replacement washer bottle as shown. Wet the grommets with soapy water and insert the two washer pumps and fill tube.



f. Secure the new washer bottle with the three air box bracket bolts removed in step 3c. Reconnect the two feeder lines and the two electrical connectors to the pumps.

4. Installation of AEM® intake system.

- a. When installing the intake system, do not completely tighten the hose clamps or mounting hardware until instructed to do so.

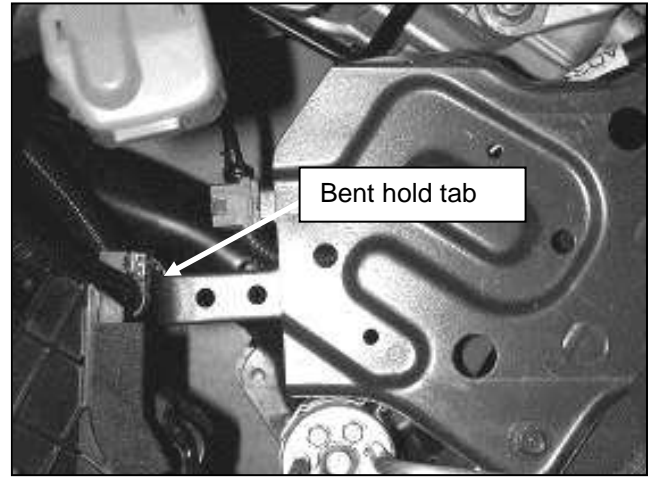
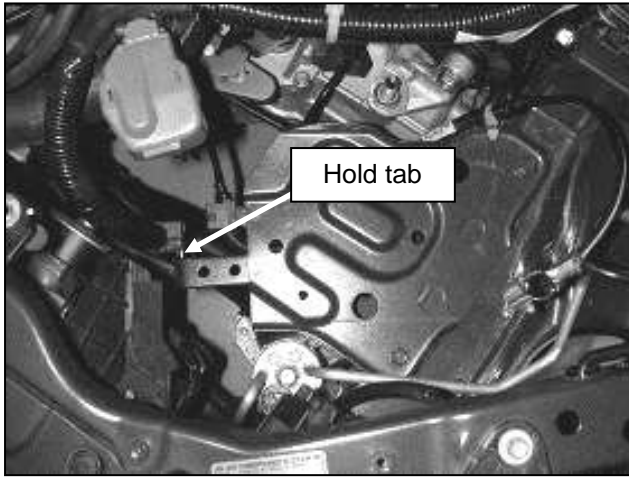

- b. With a pair of pliers bend the positive battery cable hold tab 90 degrees.



- c. Install the inlet air temp sensor. A small amount of lubricant can be used on the inside of the hole to make installation easier.

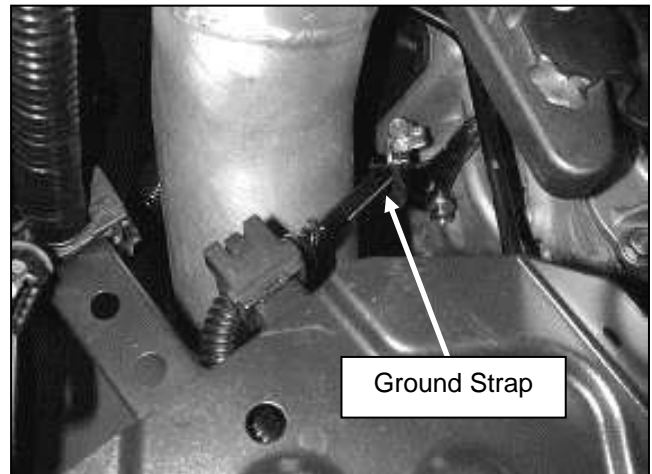

- d. Loosen the bolt securing the ground strap to the transmission bracket and rotate so that it is installed in this manner.

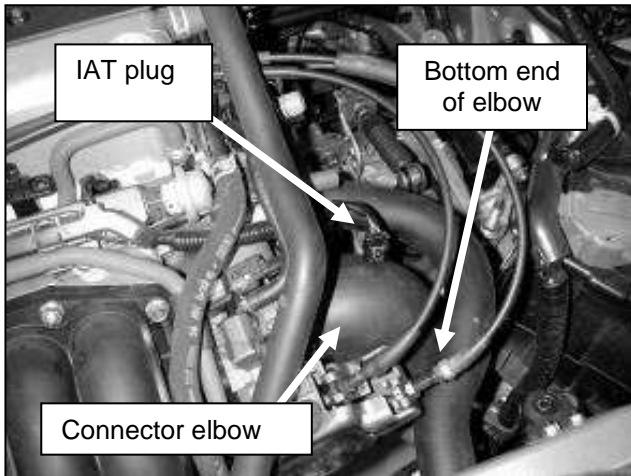

e. Using a supplied hose clamp (9444), install the supplied connector elbow onto the throttle body. Reconnect the IAT sensor. Slide supplied hose clamp (9444) onto the bottom end of elbow in preparation for the intake pipe installation.

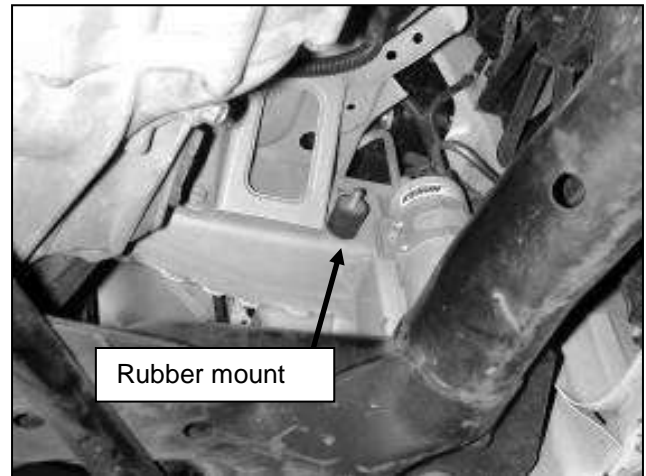

f. Remove the bolt under the battery tray and replace it with the supplied rubber mount as shown.
NOTE: Failure to install the rubber mount will void all warranties of the AEM® intake system.

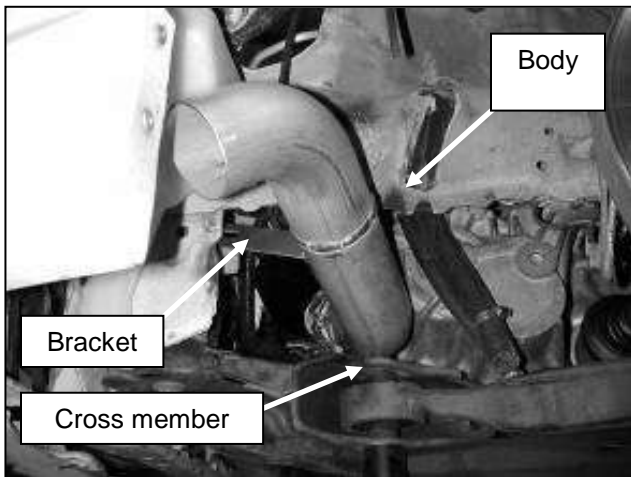

g. For ease of installation, route the intake pipe between cross member and body with bracket oriented to the upper left as shown.

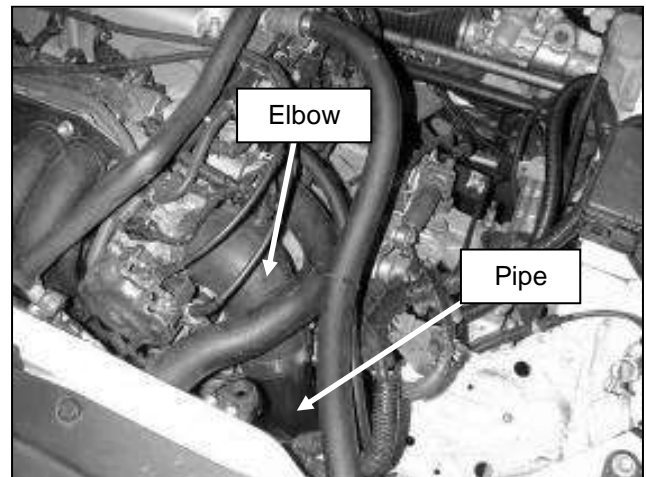

h. Install the intake pipe into the lower end of the connector elbow as shown.

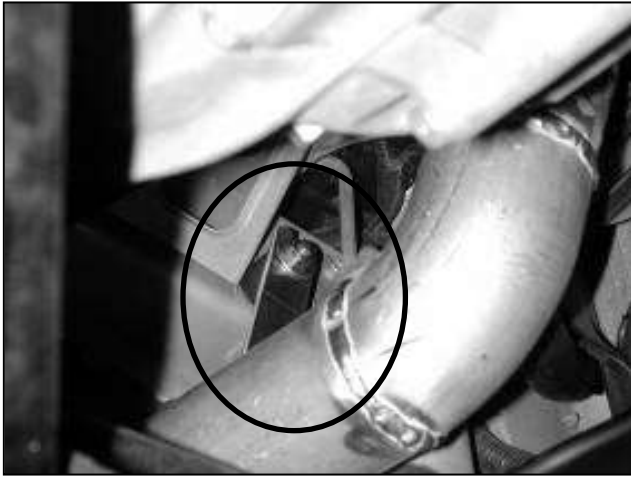

i. Secure the mounting bracket to the rubber mount with the supplied washer and nylok nut.

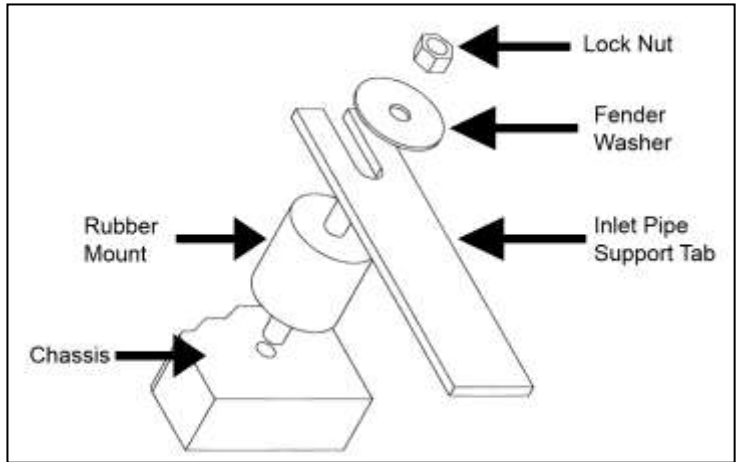

j. Proper rubber mount installation.



k. Install the AEM[®] air filter onto the lower end of the intake pipe.

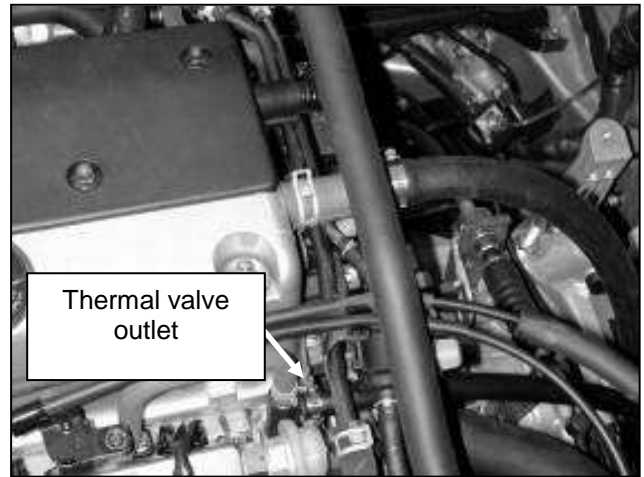

l. Connect the supplied 3/4" hose to the valve cover breather tube and the 3/8" hose to the thermal valve outlet using the supplied clamps.

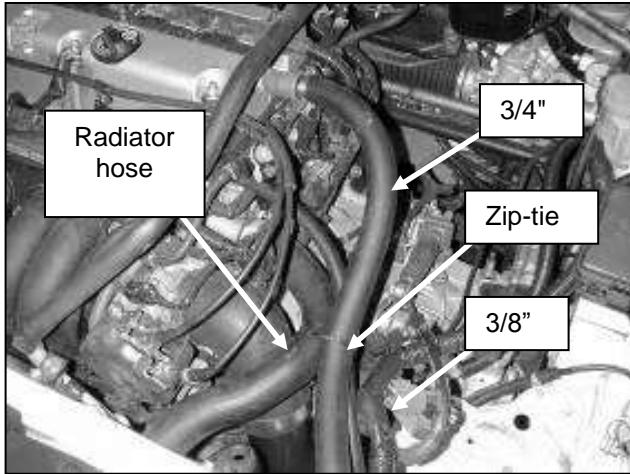

m. Secure 3/4" and 3/8" hoses to the upper radiator hose with supplied 11" zip-tie.

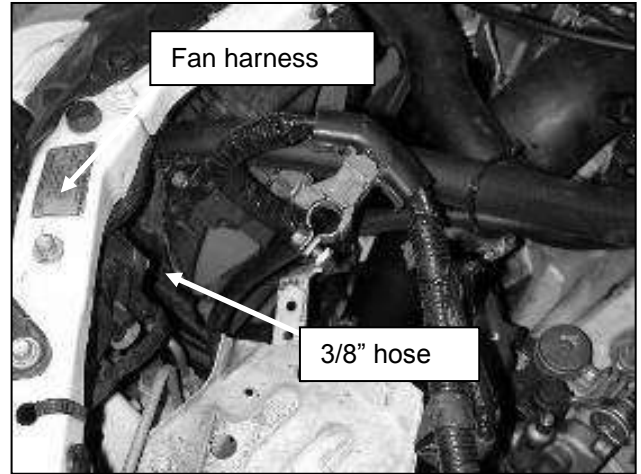

n. Route the 3/4" breather tube behind the fan wiring harness. Route the 3/8" hose between the fan shroud and battery tray as shown.



o. Connect the 3/4" and 3/8" hoses to the intake pipe and secure with the supplied clamps as shown.

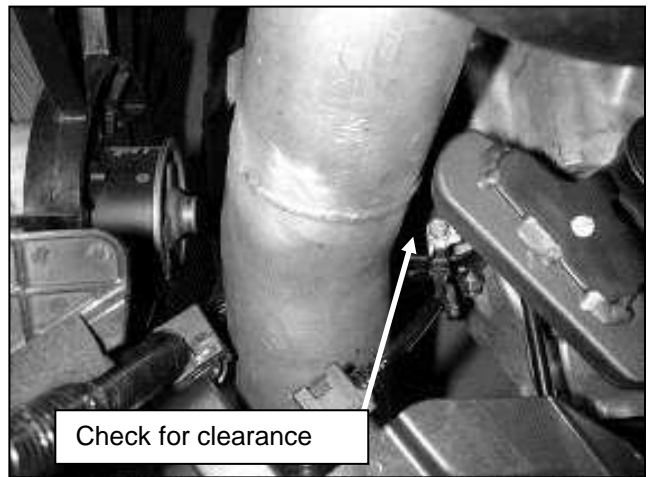

p. Check for clearance between the intake pipe and the shift arm. Watch the arm as it is shifted through its full range of motion and ensure proper clearance.

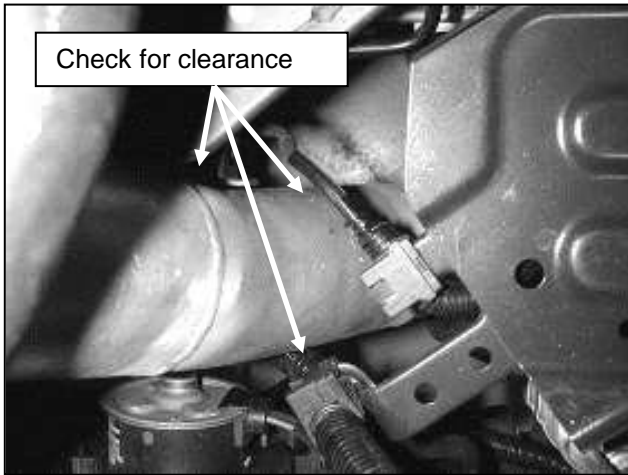

q. Check for clearance between the intake pipe and surrounding objects.



r. Install the left fender well lining and lower splashguard that were removed in step 1eii. The fender liner must be trimmed for the intake system to fit properly. Trim and reinstall the fender liner as shown. Failure to do so will void the warranty.



AEM® intake system installed

5. Reassemble Vehicle

- a. **Wheel:** Install the driver's side wheel using the factory torque specification (see owner's manual).
- b. **Washer Bottle:** Fill the new 3 Qt. washer bottle with the windshield washer fluid that was drained earlier in step 3b.
- c. **Battery Assembly:** Install the battery tray, battery and battery hold down bracket that were removed in step 2g.
- d. Position the inlet pipes for the best fitment. Be sure that the pipes or any other components do not contact any part of the vehicle. Tighten the rubber mount, all bolts, and hose clamps.
- e. Check for proper hood clearance. Re-adjust pipes if necessary and re-tighten them.
- f. Inspect the engine bay for any loose tools and check that all fasteners that were moved or removed are properly tightened.

g. Reconnect battery terminals and start engine. Let the vehicle idle for 3 minutes. Perform a final inspection before driving the vehicle.

NOTE: When the battery has been disconnected and reconnected, some abnormal drive symptoms may occur while the vehicle relearns its idle characteristics. The vehicle may need to be driven 10 miles or more to re-learn the idle curve.

6. CARB Sticker Placement

a. The C.A.R.B. exemption sticker, (attached), must be visible under the hood so that an emissions inspector can see it when the vehicle is required to be tested for emissions. California requires testing every two years other states may vary.

7. Service and Maintenance

a. AEM Induction Systems requires cleaning the intake system's air filter element every 100,000 miles. When used in dusty or off-road environments, our filters will require cleaning more often. We recommend that you visually inspect your filter once every 25,000 miles to determine if the screen is still visible. When the screen is no longer visible some place on the filter element, it is time to clean it. To clean, purchase our Synthetic air filter cleaner, part number 99-0624 and follow the easy instructions.

b. Use window cleaner to clean your powder coated AEM[®] intake tube.

NOTE: DO NOT USE aluminum polish on powder coated AEM[®] intake tubes.