



Equipped with AEM® *Dryflow Filter*
 No Oil Required!

INSTALLATION INSTRUCTIONS

PART NUMBER:

21-493B (Blue Finish)

21-493C (Gun Metal Grey Finish)

21-493P (Vacuum Metalized Chrome-VMC)

21-493R (Red Finish)

2005	VOLKSWAGEN	Jetta	L4-1.8L F/I	Prod. to 06/05	C.A.R.B. E.O. # D-670-15
2000-2004	VOLKSWAGEN	Jetta	L4-1.8L F/I		C.A.R.B. E.O. # D-670-15
2000-2005	VOLKSWAGEN	Golf GTI	L4-1.8L F/I		C.A.R.B. E.O. # D-670-15
1999-2003	VOLKSWAGEN	Jetta	L4-1.9L DSL		C.A.R.B. E.O. # D-670-15
1999	VOLKSWAGEN	Jetta	L4-1.9L DSL	Prod. from 06/99	C.A.R.B. E.O. # D-670-15
1999-2003	VOLKSWAGEN	Golf	L4-1.9L DSL		C.A.R.B. E.O. # D-670-15
1999	VOLKSWAGEN	Golf	L4-1.9L DSL	Prod. from 06/99	C.A.R.B. E.O. # D-670-15

PARTS LIST

Description	Qty.	Part Number
Element Parts Kit 2.75 X 5" Dry Ele.	1	21-202DK
Inlet Pipe	1	2-512
Hose, Silicone 2.75x2" Black	1	5-272
Hose; 5/8"ID X 19"L	1	5-7019
Mount, Rubber 1" X 6mm	1	1228599
Zip Tie, 6 Long	2	1-113
Vacuum Cap 5/8	1	8-163
Adapter, Vacuum Hose	1	2-649
Hose; 5/32"ID X 14"L	1	5-3014
Hose Mender; 3/16" X 3/16" Barbed	2	08703
Washer, 6mm Soft Mount	4	08160
Nut, M6 Hex Serrated	3	444.460.04
Hose Clamp #6 Mini	2	08407
1/2" Bnd. Hose Clamp,2.31-3.25"	2	9444
1/2" Bnd. Hose Clamp,2.56"-3.50"	1	9448

Read and understand these instructions **BEFORE** attempting to install this product. Failure to follow installation instructions and not using the provided hardware may damage the intake tube, throttle body and engine.

The AEM[®] intake system is a performance product that can be used safely during mild weather conditions. During harsh and inclement weather conditions, you must return your vehicle to stock OEM air box and intake tract configuration. Failure to follow these instructions will void your warranty.

1. Preparing Vehicle

- a. Make sure vehicle is parked on level surface.
- b. Set parking brake.
- c. If engine has run in the past two hours, let it cool down.
- d. Lift the plastic battery cover and disconnect both battery terminals.
- e. Do not discard stock components after removal of the factory system.

2. Removal of stock system

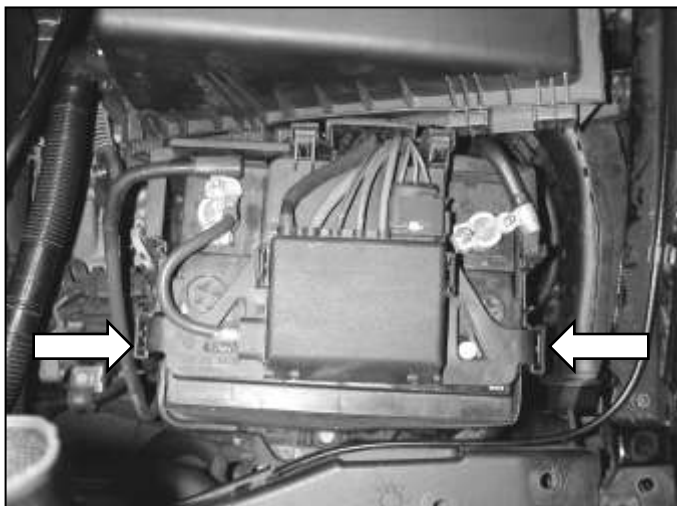

a. Pull the battery box cover straight up off of the battery box. Squeeze the tabs on the sides of the wire harness tray and lift.



b. Remove the wire harness tray from the vehicle.

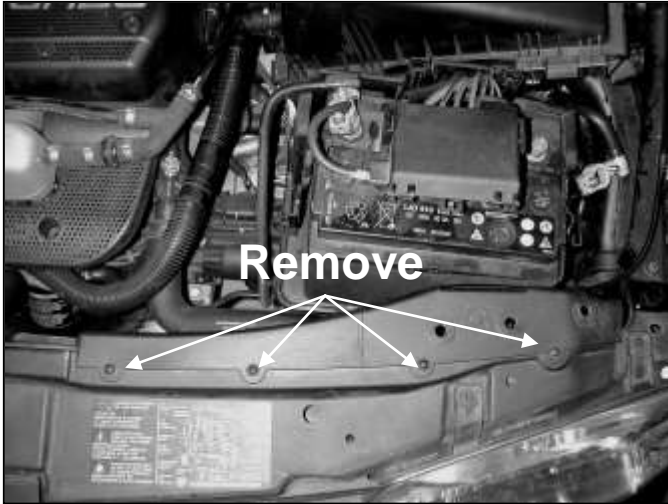

c. Remove the four screws along the top of the radiator support. Remove the two plastic covers.



d. Remove the battery hold down bolt and remove the battery from the vehicle.

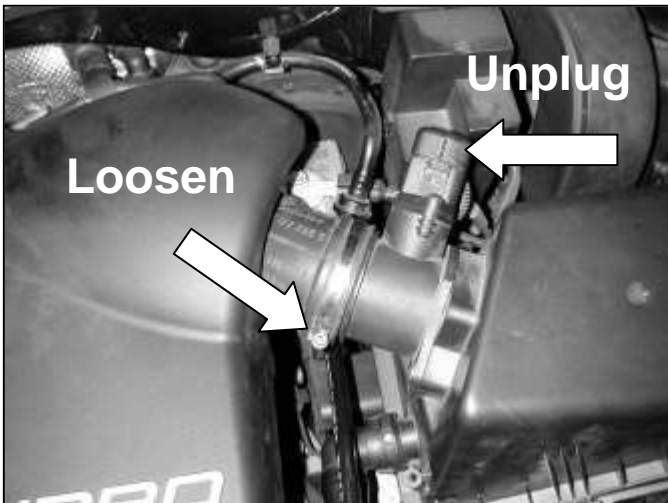

e. Unplug the wire harness from the MAF sensor. Loosen the hose clamp on the engine side of the MAF sensor. Pull the rubber tube off of the MAF sensor.

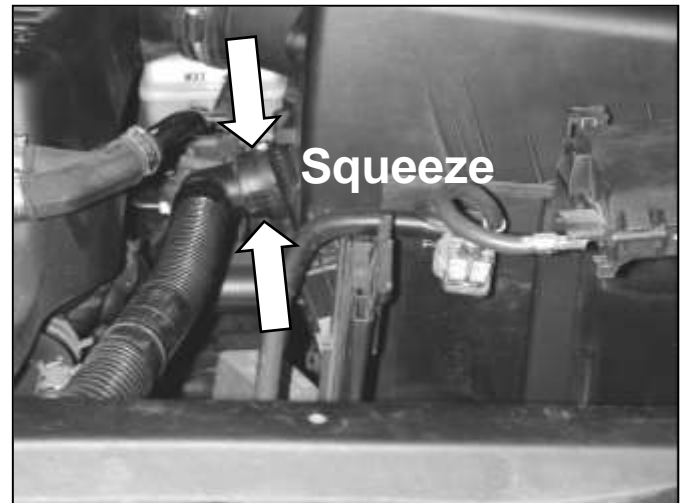

f. Squeeze the top and bottom of the breather hose. Pull the breather hose clear from the air box.
NOTE: N/A for diesel models.

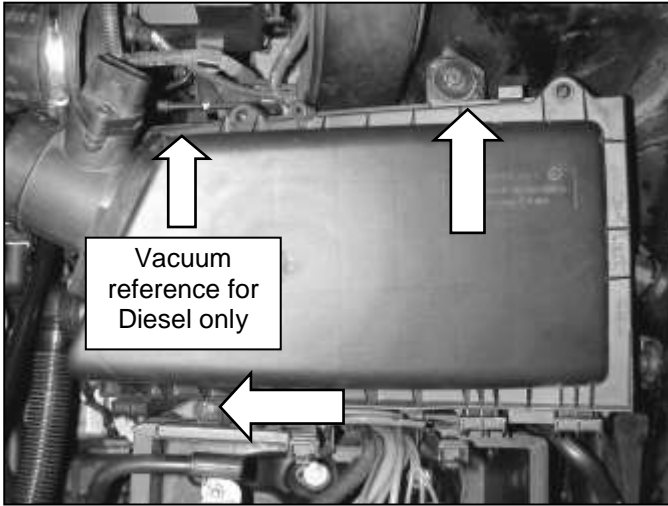

g. Remove the two bolts that retain the air box. Remove the air box and MAF sensor assembly from the vehicle.

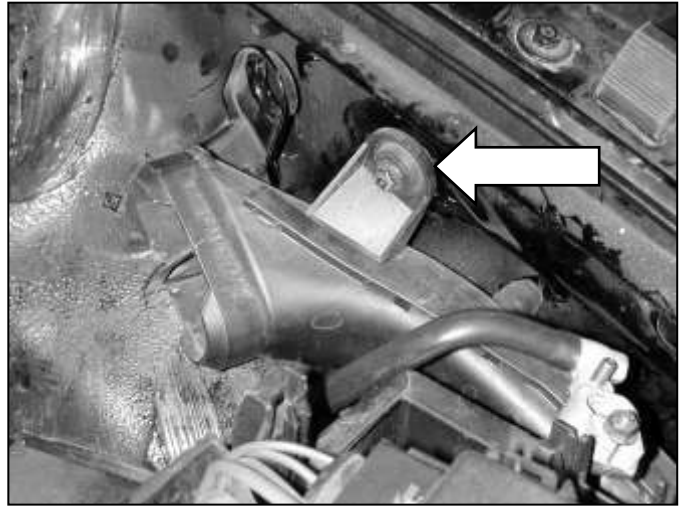

h. Remove the nut that secures the lower air duct to the fender well. Remove the lower air duct.

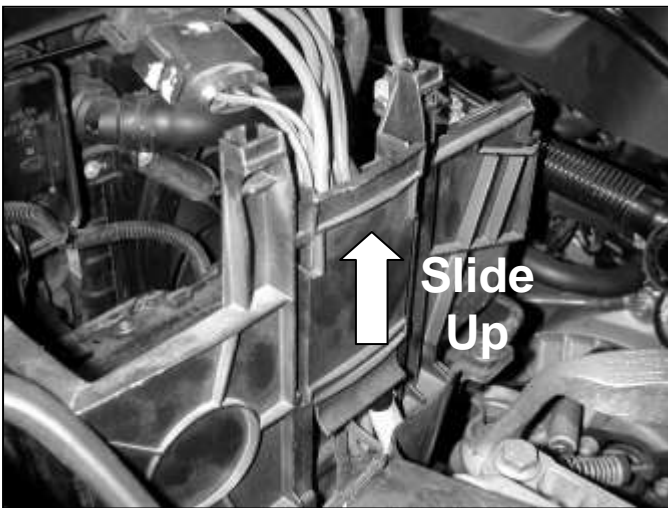

i. Slide the wire channel upwards and remove it from the back of the battery box.

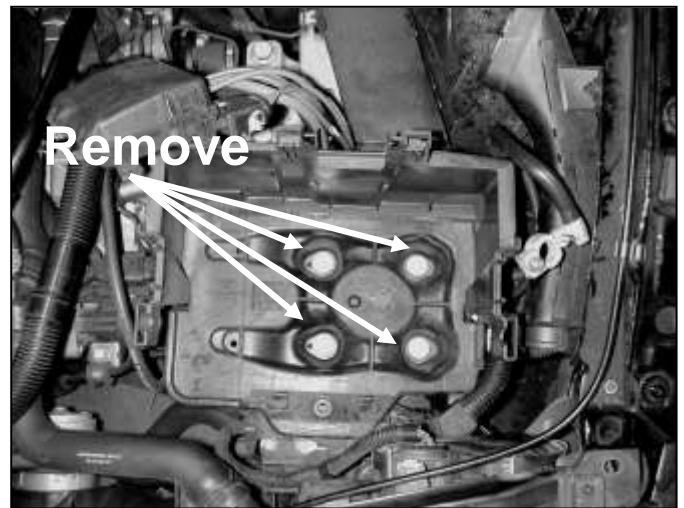

j. Remove the four bolts that hold the battery tray in. Remove the battery tray from the vehicle.



k. Lift the wire harness connector out of the plastic cradle on the inner fender well.

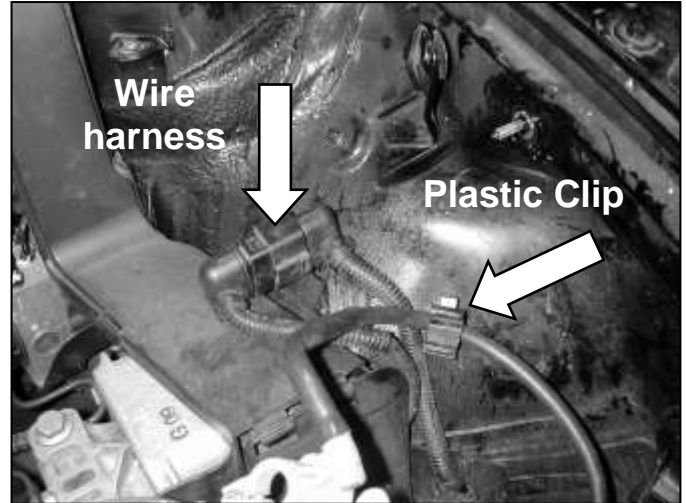

l. Move the wire harness removed in the previous step to the opposite side of the plastic ground cable clip.

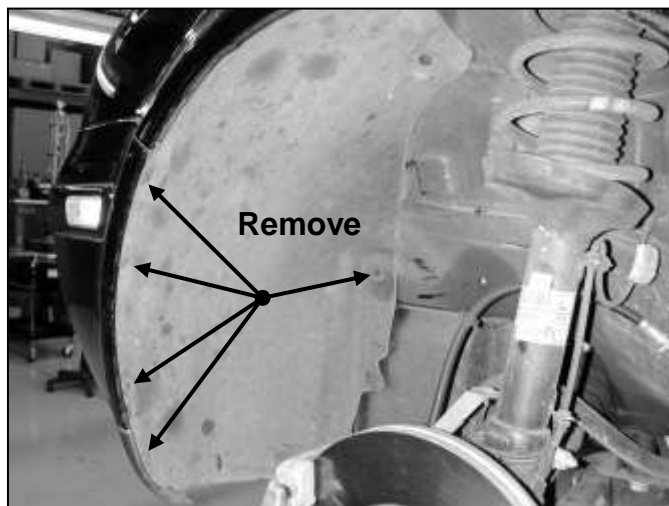

m. Raise the front of the vehicle with a jack. Refer to your owner's manual for proper jack and jack stand placement to properly support vehicle. Support your vehicle using properly rated jack stands before wheel removal or while working under the vehicle.
NEVER WORK UNDER A VEHICLE WITHOUT USING JACK STANDS.

Remove the driver side wheel. Remove the screws retaining the plastic wheel well liner. Pull the plastic liner back to expose the area behind the front bumper.



n. Squeeze the tabs on the plastic cradle that used to hold the wire harness connector in the engine bay. Remove the plastic cradle.

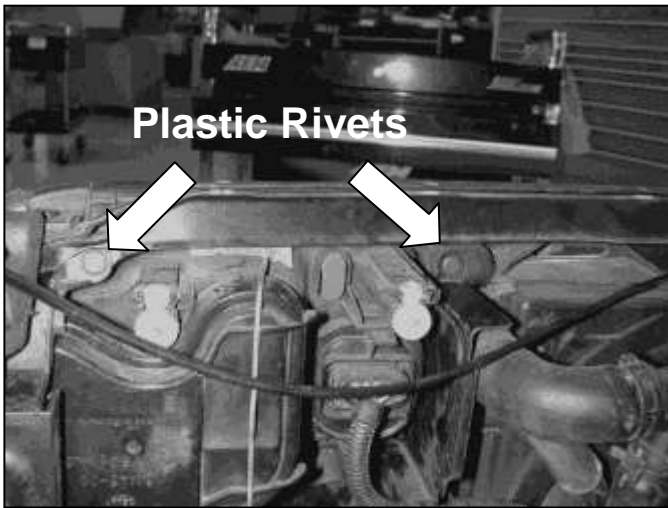

o. Remove the two plastic rivets along the top edge of the radiator support. These rivets are released by pushing the center through with a small, blunt object.

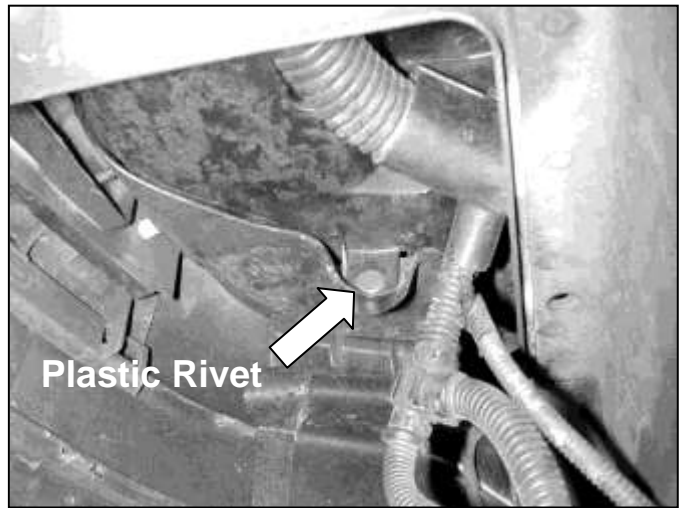

p. Remove the one plastic rivet underneath the headlight housing.

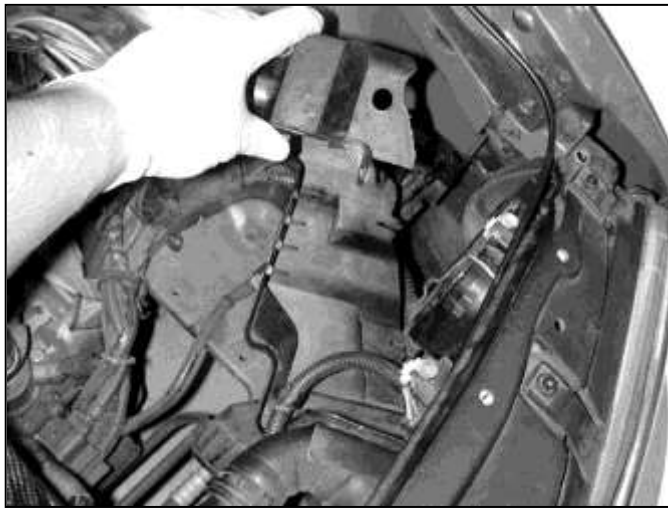

q. Pull the plastic guard from the engine bay. This piece will not be reused with the AEM[®] intake system.

3. Installation of AEM[®] intake system.

- a. When installing the intake system, do not completely tighten the hose clamps or mounting hardware until instructed to do so.



- b. Using one supplied washer and one M6 nut, install the supplied rubber mount into the hole beneath the battery tray that is towards the fender.



- c. The rubber mount should be installed from the bottom with the washer and M6 nut on top.

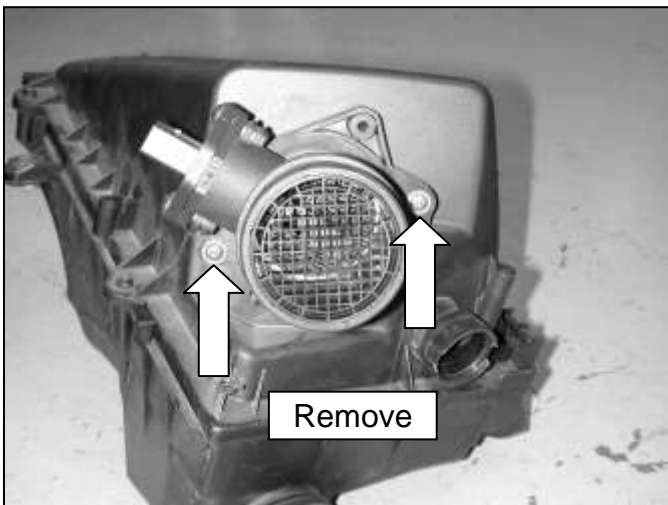

- d. Loosen the two Phillips head screws that secure the MAF sensor to the air box.



- e. Install the MAF sensor into the stock rubber intake hose using the factory hose clamp. Loosely install the coupler onto the other end of the MAF sensor with the supplied hose clamps.



f. Place one of the supplied washers on the stud that the factory lower air duct was mounted to.

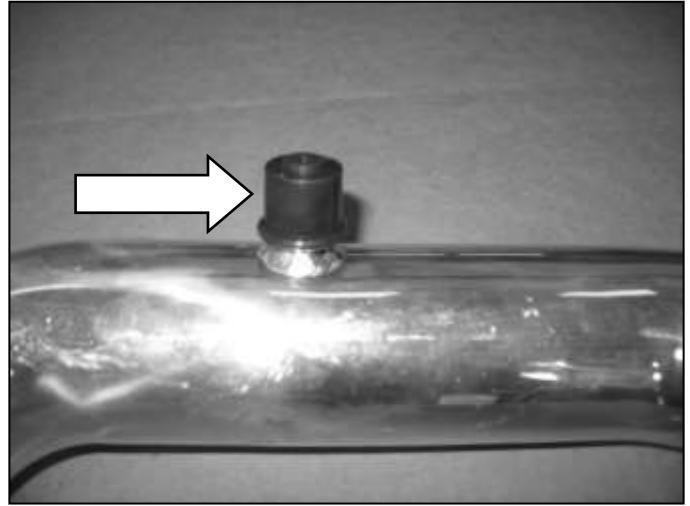

g. **Non-Diesel vehicles proceed to step i.**
Diesel vehicles: Attach the 5/8" vacuum cap onto the nipple.



h. **Diesel vehicles:** Secure the vacuum cap with the 6" zip tie. Trim excess.



i. Insert the AEM[®] intake pipe from the engine bay down into the fender well. Loosely secure the MAF sensor end of the AEM[®] intake pipe to the MAF sensor with the supplied hose clamp. Reconnect MAF sensor.



j. **Non-Diesel vehicles proceed to step l.**
Diesel vehicles: Insert the vacuum connector into the cap. The connector should be snug.



k. **Diesel vehicles:** Insert the vacuum connector into the factory vacuum reference line disconnected in step 2g. Join both connectors with the supplied vacuum line.



l. Loosely secure the upper pipe bracket to the previously installed stud using a supplied washer and M6 nut.



m. Loosely secure the lower bracket to the rubber mount that was installed in step 3b using a supplied washer and M6 nut.

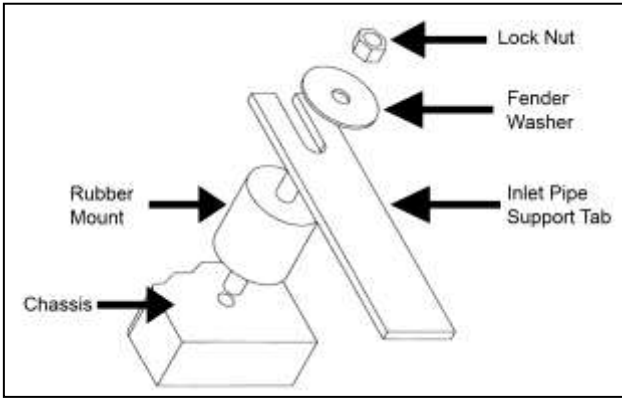

Proper installation of rubber mount assembly.

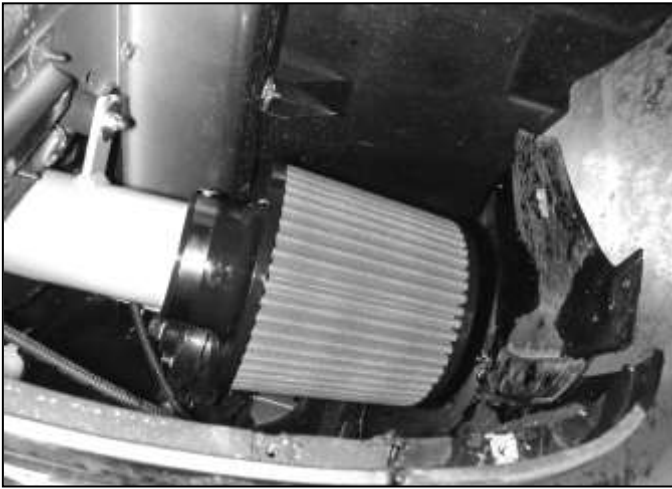

n. Install the AEM[®] air filter on to the end of the AEM[®] intake pipe with the provided hose clamp. Adjust the intake pipe and air filter to ensure that the assembly does not contact the vehicle at any point. Tighten the M6 nuts and hose clamps. The installation for diesel vehicles stops here, proceed to Step 4.

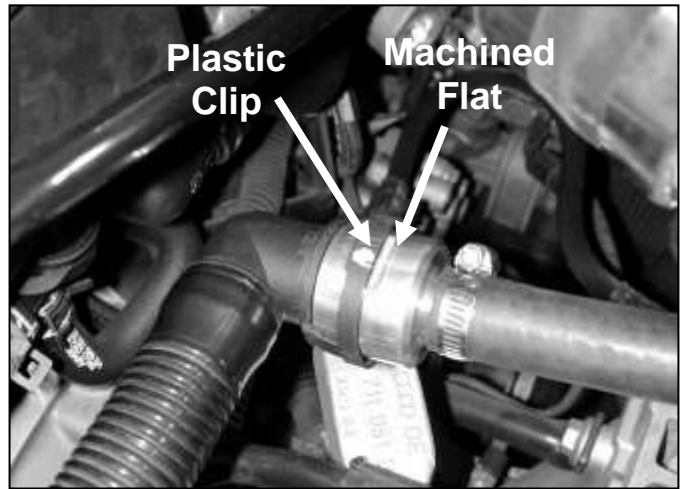

o. Connect the factory breather hose to the AEM[®] vacuum hose adapter. Line the clips on the plastic hose up with the flats machined into the adapter. It may be helpful to lubricate the o-ring with a small amount of soap. Use caution to avoid damaging the o-ring.



p. Install the supplied 5/8" vacuum hose section from the AEM® adapter to the nipple on the back of the AEM® intake pipe with the two supplied 1" hose clamps. Route the hose in a broad arc under the AEM® intake pipe to avoid kinks.

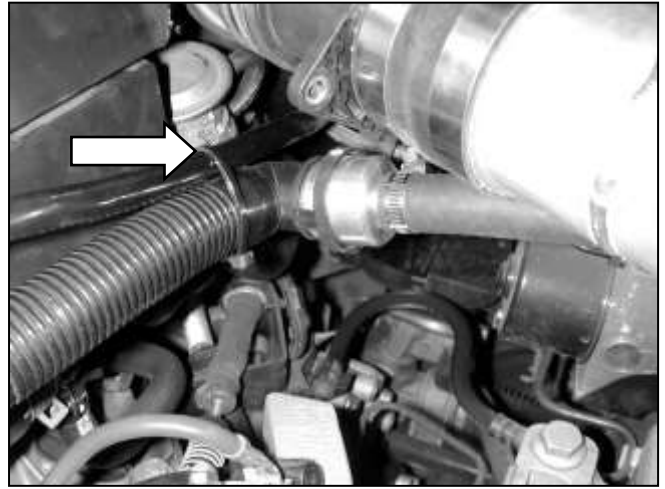

q. Use the supplied plastic zip tie to secure the large breather tube to the smaller one just above it.

4. Reassemble Vehicle

- a. Reassemble the vehicle in the reverse order of disassembly.
- b. **Fender liner:** Install the fender liner and any hardware that was removed in steps 2(m).
NOTE: Failure to install the fender liner will result in diminished performance and increase the potential for engine damage due to water ingestion in rainy conditions.
- c. **Wheel:** Install the driver side wheel using the factory torque specification (see owner's manual).
- d. Position the inlet pipes for the best fitment. Be sure that the pipes or any other components do not contact any part of the vehicle. Tighten the rubber mount, all bolts, and hose clamps.
Critical points to check are on the corner of the plastic battery box and at the bend of the intake pipe just above the air filter.
- e. Check for proper hood clearance. Re-adjust pipes if necessary and re-tighten them.
- f. Inspect the engine bay for any loose tools and check that all fasteners that were moved or removed are properly tightened.
- g. Reconnect negative and positive battery terminals and start engine. Let the vehicle idle for 3 minutes. Perform a final inspection before driving the vehicle.

5. CARB Sticker Placement

- a. The C.A.R.B. exemption sticker, (attached), must be visible under the hood so that an emissions inspector can see it when the vehicle is required to be tested for emissions. California requires testing every two years, other states may vary.

6. Service and Maintenance

- a. AEM Induction Systems requires cleaning the intake system's air filter element every 100,000 miles. When used in dusty or off-road environments, our filters will require cleaning more often. We recommend that you visually inspect your filter once every 25,000 miles to determine if the screen is still visible. When the screen is no longer visible some place on the filter element, it is time to clean it. To clean, purchase our Synthetic air filter cleaner, part number 99-0624 and follow the easy instructions.
- b. Use window cleaner to clean your powder coated AEM[®] intake tube.

NOTE: DO NOT USE aluminum polish on powder coated AEM[®] intake tubes.