



Equipped with AEM® *Dryflow™ Filter*
No Oil Required!

The installation of this AEM® intake system requires some modification to the vehicle's inner fender. A specialized power tool will be needed to modify the vehicle's inner fender so the AEM intake system can be installed. When using any power tools always use proper eye and hand protection. See steps 3B and 3C to see the details describing the necessary modification.

INSTALLATION INSTRUCTIONS

PART NUMBER:

21-406B	(Blue Finish)
21-406C	(Gun Metal Grey Finish)
21-406P	(Vacuum Metalized Chrome-VMC)
21-406R	(Red Finish)

1997-2001 HONDA Prelude L4-2.2L

C.A.R.B. E.O. # D-670-15

PARTS LIST

Descriptions	Qty.	Part Number
Element Parts Kit 3.00 X 5" Dry Ele.	1	21-203DK
Inlet Pipe	1	2-421
Hose; 5/16ID X 16"L	1	5-2016
Hose, Adapter 2.75/3.00 X 3" Blk.	1	5-273
Hose; 3/8"ID X 12"L	1	5-1012
Mount, Rubber 1" X 6mm	1	1228599
Vacuum Cap, 1/8"	1	8-105
Washer, 6mm Soft Mount	1	08160
Nut, M6 Hex Serrated	1	444.460.04
Hose Clamp, 3/4"	4	4093-5
1/2" Bnd. Hose Clamp, 2.31-3.25"	1	9444
1/2" Bnd. Hose Clamp, 2.56"-3.50"	1	9448
1/2" Bnd. Hose Clamp, 2.90"-3.75"	1	9452

Read and understand these instructions BEFORE attempting to install this product. Failure to follow installation instructions and not using the provided hardware may damage the intake tube, throttle body and engine.

The AEM[®] intake system is a performance product that can be used safely during mild weather conditions. During harsh and inclement weather conditions, you must return your vehicle to stock OEM air box and intake tract configuration. Failure to follow these instructions will void your warranty.

1. Preparing Vehicle

- a. Make sure vehicle is parked on level surface.
- b. Set parking brake.
- c. If engine has run in the past two hours, let it cool down.
- d. Disconnect negative battery terminal.
- e. Do not discard stock components after removal of the factory system.

2. Removal of stock system

- a. The following items will be removed from the vehicle.
 - i. The OE inlet tube.
 - ii. The air filter case.
 - iii. Intake air noise resonators underneath the air filter case (inside fender well).
- b. Removal of intake air tube.
 - i. Disconnect the breather tube assembly.
 - a. **NOTE: The engine should be cool before performing this step so that HOT coolant is not released out of the engine. Be sure to capture any lost coolant in a clean container.**
Disconnect the water bypass hose from throttle body or the fast idle thermo valve, where equipped, located at the lower portion of the throttle body. Disconnect the opposite side of the water bypass hose, which runs to either the intake manifold or the water outlet neck. Remove the entire water bypass hose and breather hose assembly from the vehicle.
 - b. Disconnect the metal breather tube from both the cam cover and the stock air inlet tube.
- c. Loosen the hose clamp holding the air tube to the throttle body.
 - i. Remove the inlet hose from the throttle body and carefully lift it up.
 - ii. Separate the inlet tube from the air filter case and lift the inlet tube out and away from the area of work.
- d. Disconnect the vacuum hoses and electrical connections that run to the Intake Air Control (IAC) solenoid valve. This valve controls the Intake Control Diaphragm (ICD). These components reduce the amount of intake noise generated in the stock system. The AEM intake system eliminates these components.
 - i. Remove the IAC solenoid valve from the vehicle. For reference, the IAC solenoid valve is a little black box located behind the battery and underneath the stock inlet tube.
 - ii. Remove the aluminum bracket that mounts the IAC solenoid valve.
- e. Removal of air filter case.
 - i. Undo the two bolts holding the air filter case and lift it away from the vehicle. It may be easier to separate the top half from the bottom half and then remove the bottom half from the vehicle. You can then assemble the air filter case and set it aside for storage.
- f. Raise the front of the vehicle with a jack. Refer to your owner's manual for proper jack and jack stand placement to properly support vehicle. Support your vehicle using properly rated jack stands before wheel removal or while working under the vehicle.

NEVER WORK UNDER A VEHICLE WITHOUT USING JACK STANDS.

- g. Removal of the lower resonator.
 - i. Remove the lower front splashguard underneath the front of the vehicle.
 - ii. Remove the front right tire. Then remove the necessary hardware and inner fender liner.
- h. Remove the bolts holding the lower resonator from the vehicle and lower the resonator away from the vehicle.

3. Installation of AEM[®] intake system.

- a. When installing the intake system, do not completely tighten the hose clamps or mounting hardware until instructed to do so.
- b. The factory hole that the inlet pipe passes through must be enlarged for clearance of the AEM[®] intake pipe. The use of a specialized power tool will be needed to cut through the inner fender so the AEM[®] intake pipe is able to clear the inner fender opening.
- c. The area that needs to be trimmed / enlarged is the area below the actual opening as the arrows depict. Ensure that any rough or sharp edges are smoothed and that the AEM[®] intake pipe is able to clear the opening without touching any part of the inner fender.

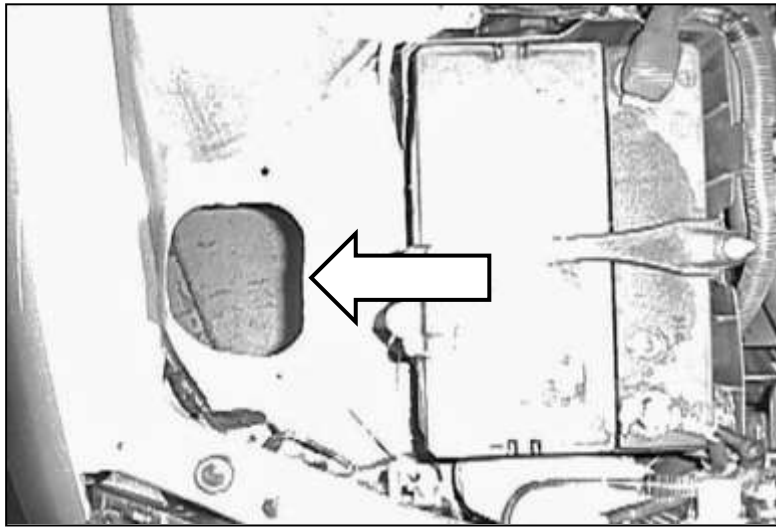

- d. Install one black connector hose on the throttle body end of the pipe. The throttle body end has the nipple next to it. Install a hose clamp on the connector hose and snug it down.
- e. Install the intake pipe into the vehicle. You may have to maneuver the intake pipe to achieve proper placement.
 - i. The support tab on the intake pipe will line up with one of the threaded holes that was used to mount the IAC solenoid valve mounting bracket. Install the rubber mount into the rearmost hole that was left exposed by the removal of the IAC solenoid valve bracket, and attach the air inlet tube onto the rubber mount. Install the large fender washer and the lock nut onto the rubber mount stud and snug it down.
NOTE: Failure to install the rubber mount will void all warranties of the intake system. Below on the next page is a diagram of how the rubber mount should be installed.
- f. Connect the new supplied water bypass hose and clamps to the throttle body or the fast idle thermo valve, where equipped, and either the intake manifold or the water outlet neck disconnected earlier.
NOTE: Replace any coolant recovered during the hose removal by replenishing the recovery tank.
- g. Install the breather hose in place of the tube that was removed earlier during step 2b. The metal tube assembly will not be used.
- h. Install the AEM[®] air filter onto the end of the inlet tube. Push the air filter on about 2 inches over the intake pipe and install one hose clamp to secure the air filter onto the inlet pipe. Once fitment is checked, you can push the air filter onto the inlet pipe more or less depending on clearances. Tighten the hose clamp after this is done.

4. Reassemble Vehicle

- a. **Fender liner and Lower Front Splashguard:** Install the fender liner, lower splashguard and any hardware that was removed in steps 2g i. and 2g ii.

NOTE: Failure to install the fender liner will result in diminished performance and increase the potential for engine damage due to water ingestion in rainy conditions.

Wheel: Install the front right wheel using the factory torque specification (see owner's manual).

- b. Position the inlet pipes for the best fitment. Be sure that the pipes or any other components do not contact any part of the vehicle. Tighten the rubber mount, all bolts, and hose clamps.
- c. Check for proper hood clearance. Re-adjust pipes if necessary and re-tighten them.
- d. Inspect the engine bay for any loose tools and check that all fasteners that were moved or removed are properly tightened.
- e. Reconnect negative battery terminals and start engine. Let the vehicle idle for 3 minutes. Perform a final inspection before driving the vehicle.

5. CARB Sticker Placement

- a. The C.A.R.B. exemption sticker, (attached), must be visible under the hood so that an emissions inspector can see it when the vehicle is required to be tested for emissions. California requires testing every two years, other states may vary.

6. Service and Maintenance

- a. It is recommended that you service your AEM[®] Dryflow[™] filter every 20,000 miles for optimum performance. Use AEM Dryflow cleaning kit part # 21-110.
- b. Use aluminum polish to clean your polished AEM[®] intake tube.
- c. Use window cleaner to clean your powder coated AEM[®] intake tube. **(NOTE: DO NOT USE aluminum polish on powder coated AEM intake tubes).**

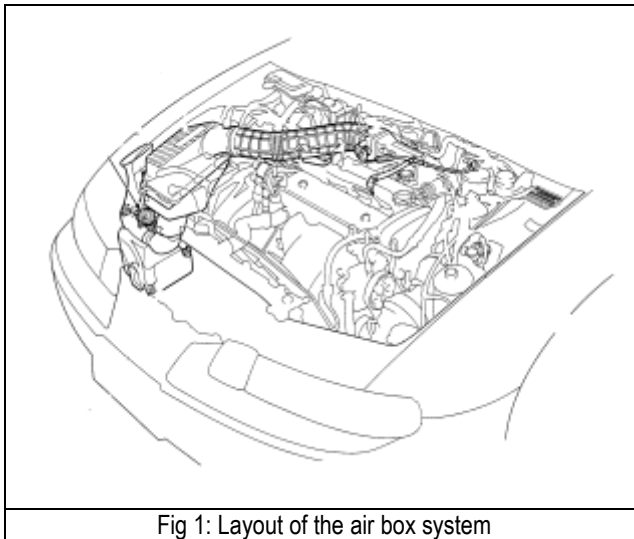

Fig 1: Layout of the air box system

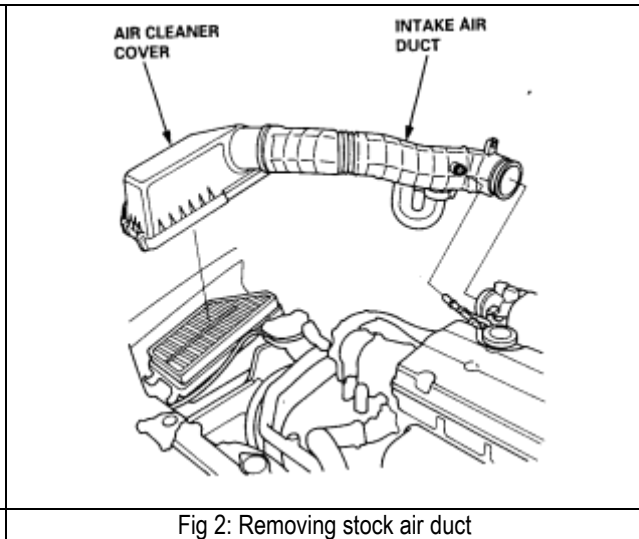

Fig 2: Removing stock air duct

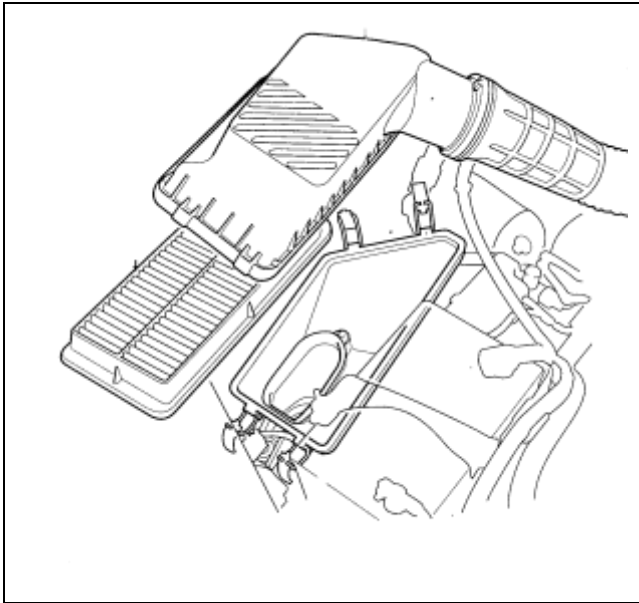

Fig 3: Air filter case

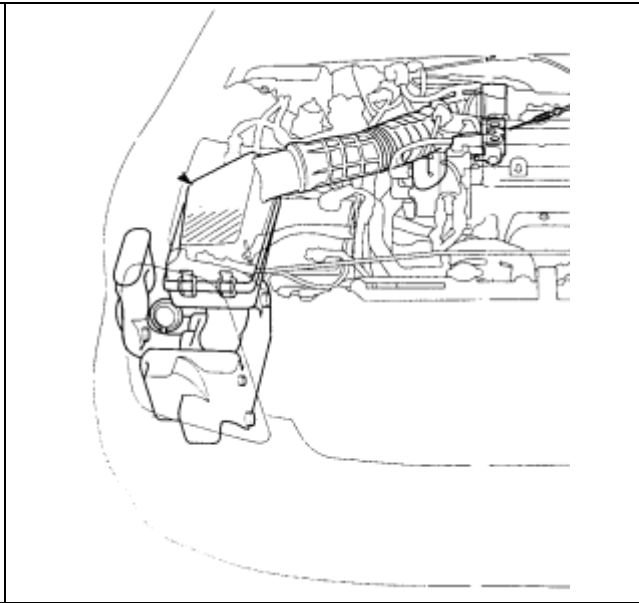

Fig 4: Air box system layout (front)

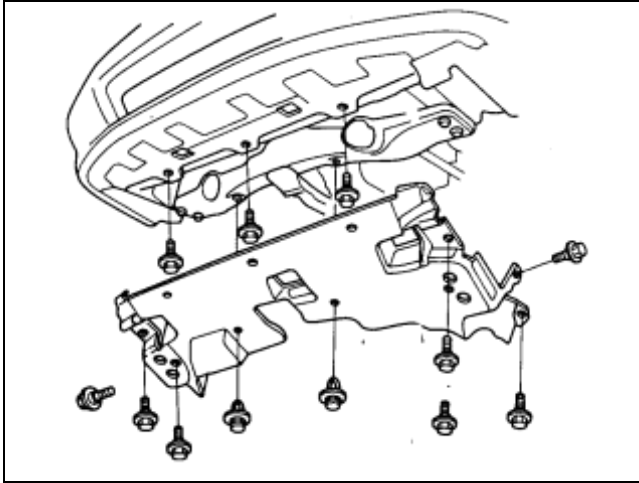

Fig 5: Lower splash shield

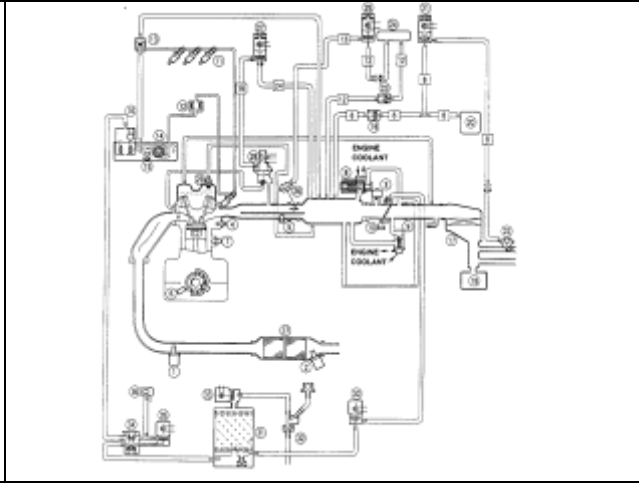

Fig 6: Vacuum hose routing

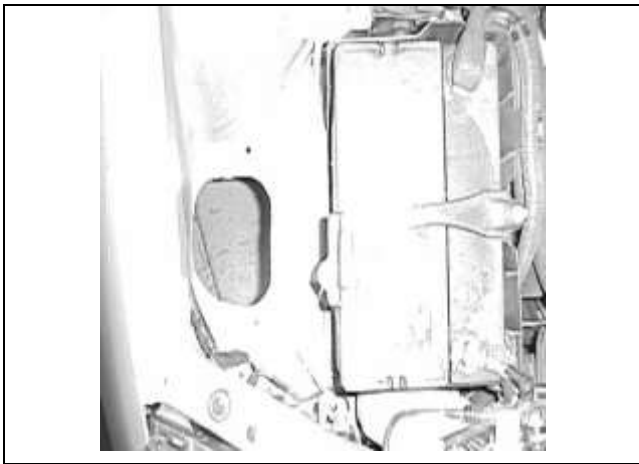

Fig 7: Hole cut into fender well (battery on right)



Fig 8: Intake tube installed

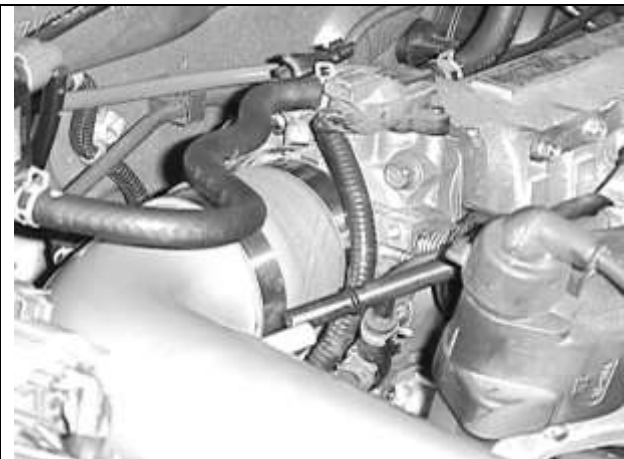

Fig 9: Connecting intake tube to the throttle body. Make note of the breather tube.



Fig 10: Breather tube and port on intake tube.



Fig 11: Intake pipe installed. Note mounting bolt.

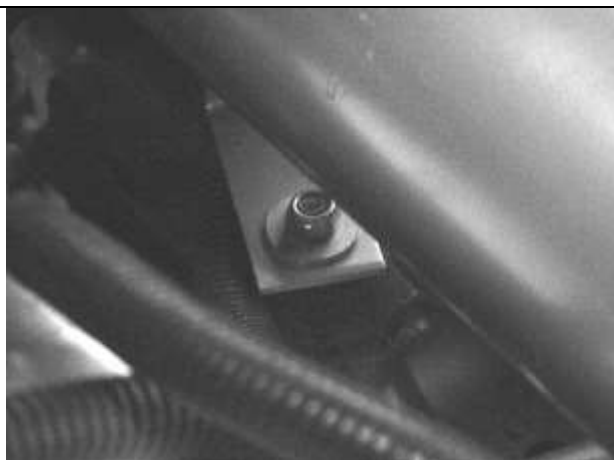

Fig 12: Mounting bolt