

Preparation:

- Disconnect the negative battery terminal. Park the vehicle on level ground and set the emergency brake.
- We recommend reading through the installation instructions in whole before performing the work.
- When button head bolts are being used, install the supplied washer on the nut side. Then, hold the bolt stationary and only turn the nut to tighten. Do not turn the bolt to tighten hardware assembly, unless otherwise noted.
- Estimated Installation Time: **3 Hours for OEM Removal/Bumper Installation**

1 Additional Hour to Wire Center Lights

1 Additional Hour to Wire Side Lights

1.5 Additional Hours to Install Winch

****This installation requires 2 people for best results****

****Labor Rates are based on a vehicle with no pre-existing damage. Wiring labor is based on a standard wiring procedure with light switches installed in an easily accessible location. Custom light triggering or switch mounting location will result in a greater labor charge.****

You will need the following tools:

- | | | |
|-----------------|-------------------------|-----------------------------|
| - Ratchet | - 3/4" Socket & Wrench | - 7/32" Allen Wrench/Socket |
| - 7mm Socket | - 10mm Socket | - 13mm Socket |
| - 15mm Socket | - 18mm Socket & Wrench | - T-10 Torx Socket |
| - Utility Knife | - 7/16" Socket & Wrench | |

Included in Kit:

- | | |
|---|--|
| 8 - Hex Head Bolts (M10-1.5 x 30mm) | 8 - Flat Washers (M10) |
| 4 - Black Button Head Bolts (3/8"-16 x 3/4") | 4 - Black Washers (3/8") |
| 4 - Nylon Lock Jam Nuts (3/8"-16) | 4 - Hex Head Bolts (1/2"-13 x 1 1/2") |
| 8 - Flat Washers (1/2") | 4 - Nylon Lock Nuts (1/2"-13) |
| 6 - Cable Ties (8" long) | 2 - Hex Head Bolts (1/4"-20 x 3") |
| 8 - Flat Washers (1/4") | 6 - Hex Nuts (1/4"-20) |
| 2 - 2" Section of Rubber Tubing (1/4" ID) | 1 - Shutter Motor Bracket (2 Pieces) |
| 1 - Winch Plate | |

Removal:

1. Using a T-10 Torx Socket, remove the three inner fender liner bolts referenced in (Fig A).



Fig A

2. Pull the front part of the fender flare back. There are no tools required for this step, they simply pull free by hand. Then remove the 7mm bolt that was hidden behind the fender flare. (Fig B)

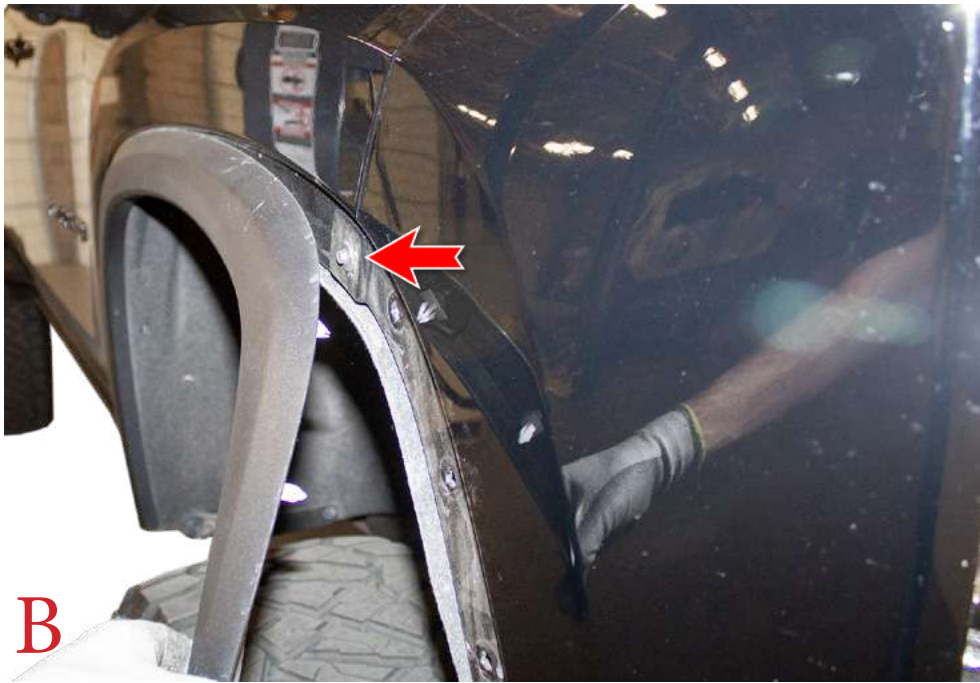


Fig B

3. Pull the valance off the vehicle. There are no tools required for this step, it simply pulls off by hand. (Fig C)



Fig C

4. Repeat Steps 1-3 on the other side of the vehicle.
5. Pop the hood. Then, use a T-10 Socket to remove the two bolts holding on the outer portion of the hood latch handle. Remove the outer portion of the hood latch handle. (Fig D)



Fig D

6. Remove the plastic clips (x9) that hold on the radiator cover. Then, remove the radiator cover from the vehicle. (Fig E)



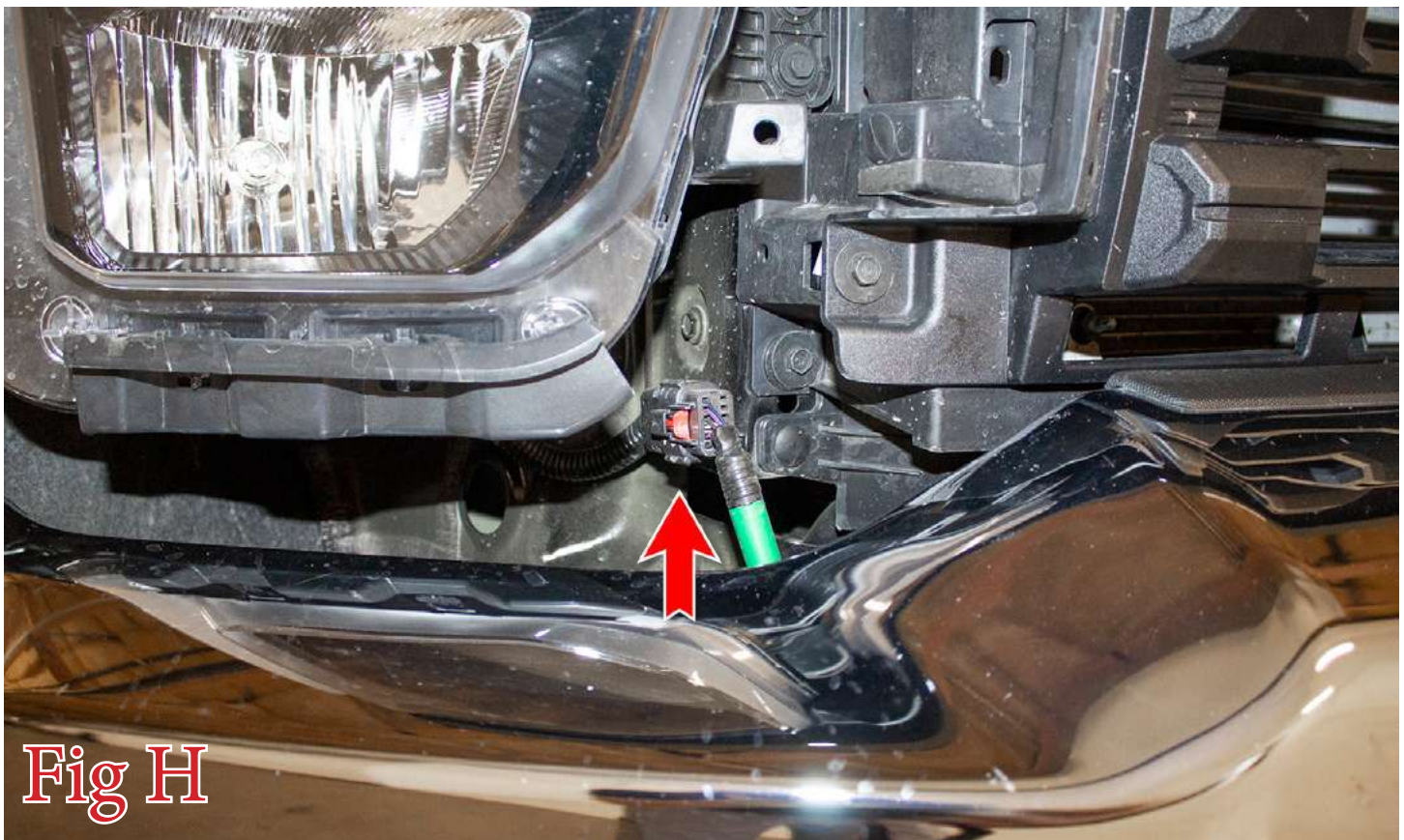
7. Use a 10mm Socket to remove the upper grille bolts (x4). (Fig F)



8. Use a 10mm Socket to remove the lower grille bolts (x2). Then, remove the grille from the vehicle. After the bolts are removed, the grille will pull off by hand. (Fig G)



9. On the passenger side of the vehicle, unplug the connector below the headlight. (Fig H)



10. On the driver side of the vehicle, unplug the connector underneath the headlight (if applicable). (Fig I)

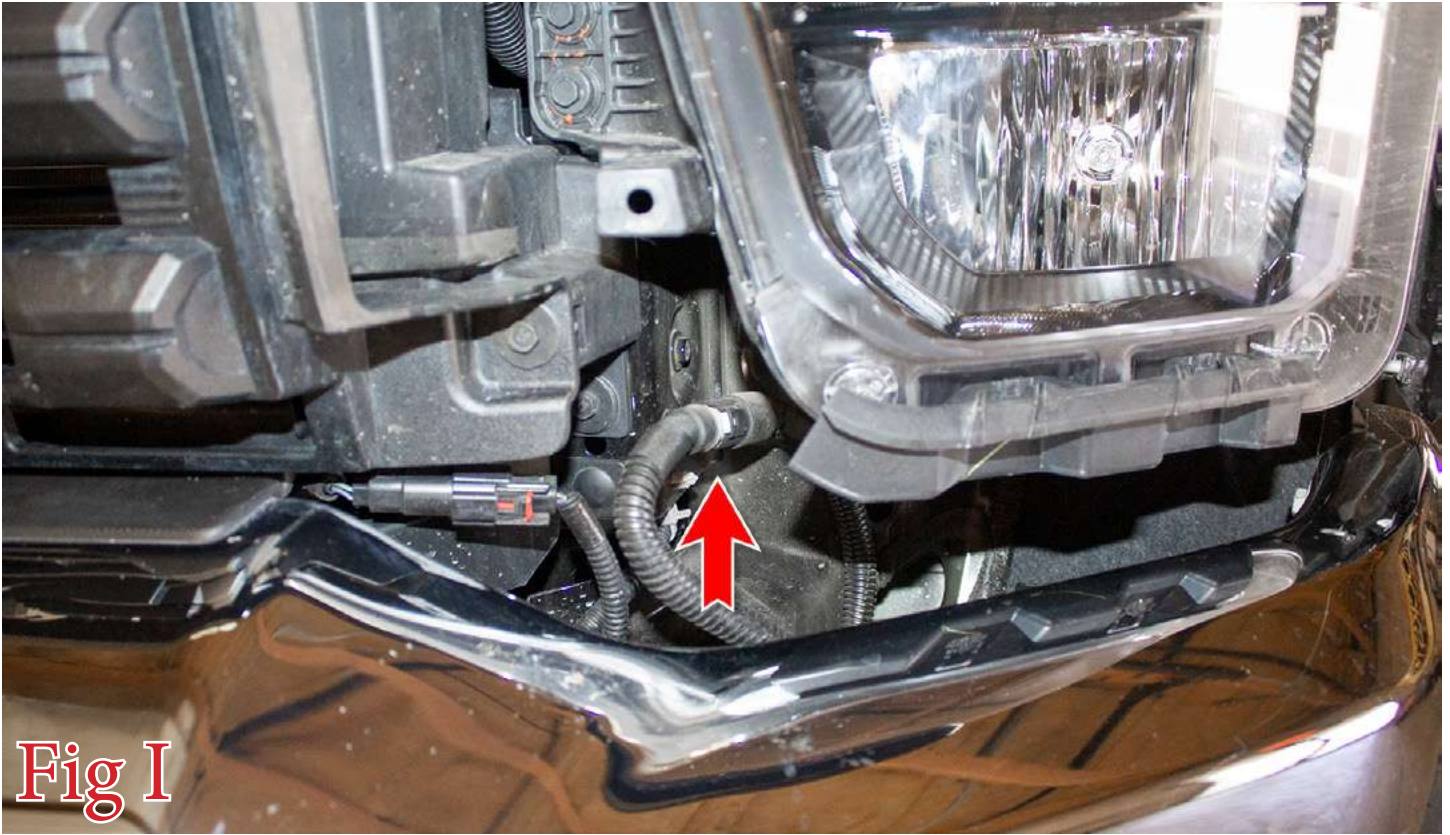


Fig I

11. From underneath the vehicle, use a 15mm Socket to remove the bumper side support bar bolts referenced in (Fig J).



Fig J

12. Looking down from the top of the bumper, there are two mounting bolts per side. Use an 18mm Socket to remove these four bolts. Then, remove the OEM bumper from the vehicle. (Fig K)



Fig K

13. Use an 18mm Socket & Wrench to remove the tow hook mounting bolts (2 per hook). Then, remove the tow hooks from the vehicle. (Fig L)

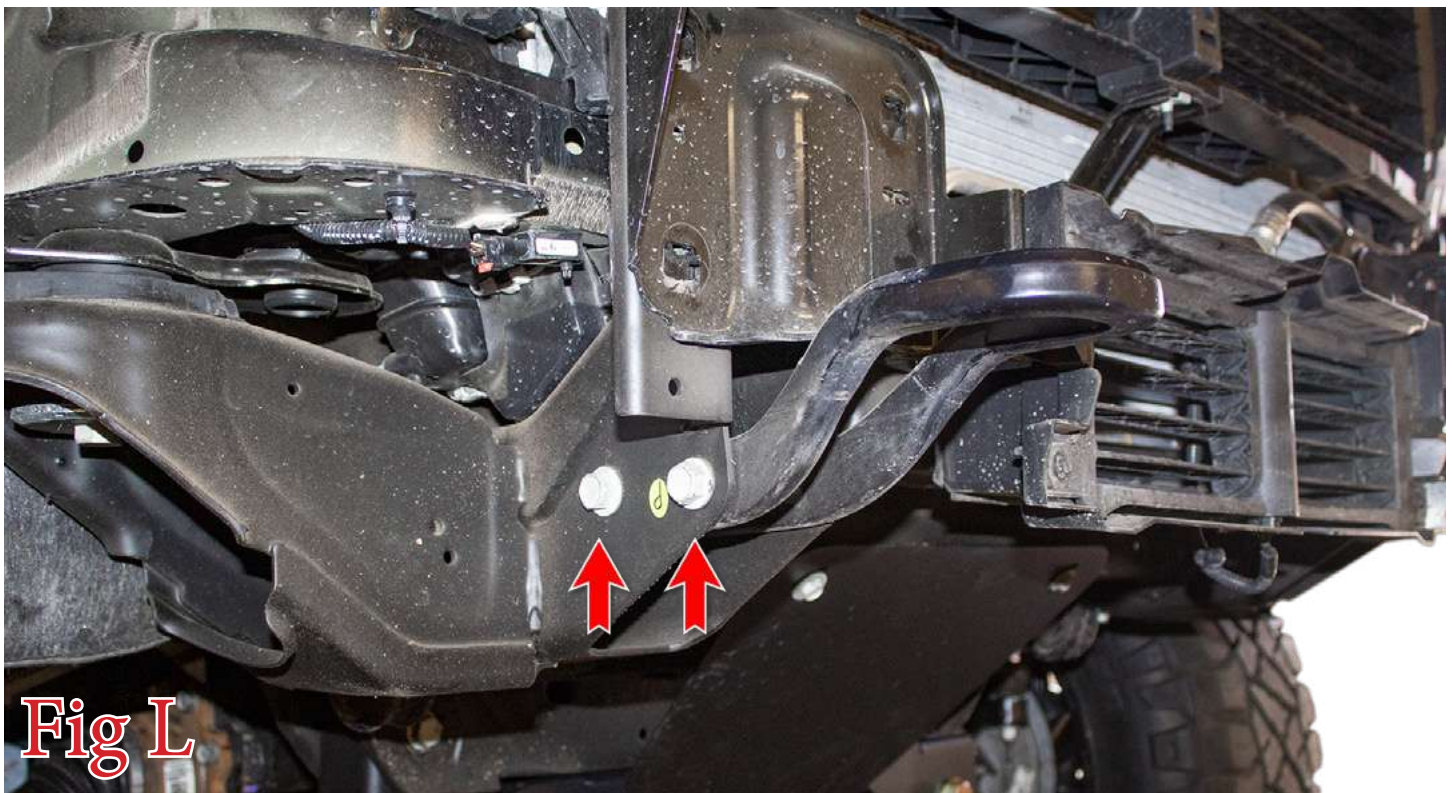


Fig L

14. Unplug the connector on the bottom side of the intercooler shutter system. (Fig M)



Fig M

15. Release the 4 plastic clips holding the shutter motor harness to the plastic scoop. (Fig N)



Fig N

**There are two more clips
along the back side**

16. Use a 15mm Socket to remove the 8 bolts that hold the bumper bracket/intercooler scoop assembly to the vehicle. Then, remove the scoop/bracket. (Fig O)

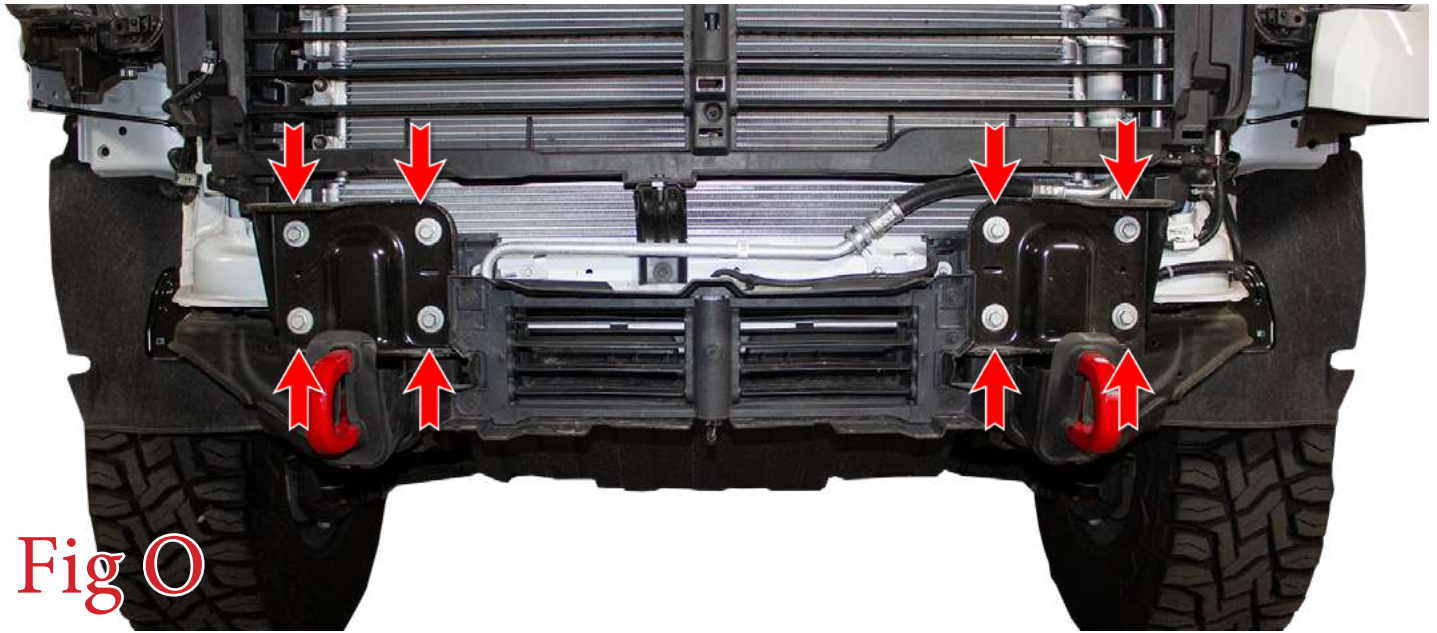


Fig O

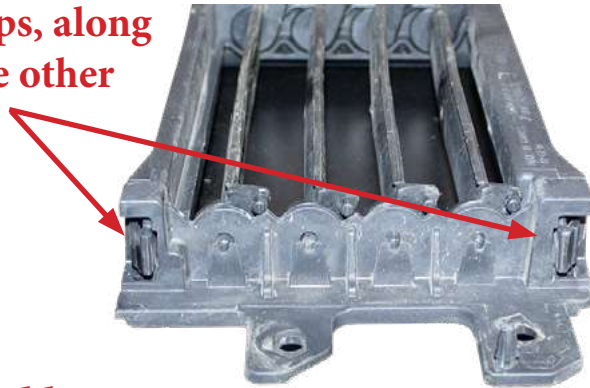
17. Using a 7mm Socket, remove the bolts mounting the intercooler scoop to the bumper bracket. Then, separate the scoop from the bracket. (Fig P)



Fig P

18. Undo the two clips (per side) on the scoop assembly. Then, remove the sides and shutters from the scoop assembly. (Fig Q)

Undo these two clips, along the two clips on the other side of the scoop.



Your scoop assembly should now look like this



Fig Q

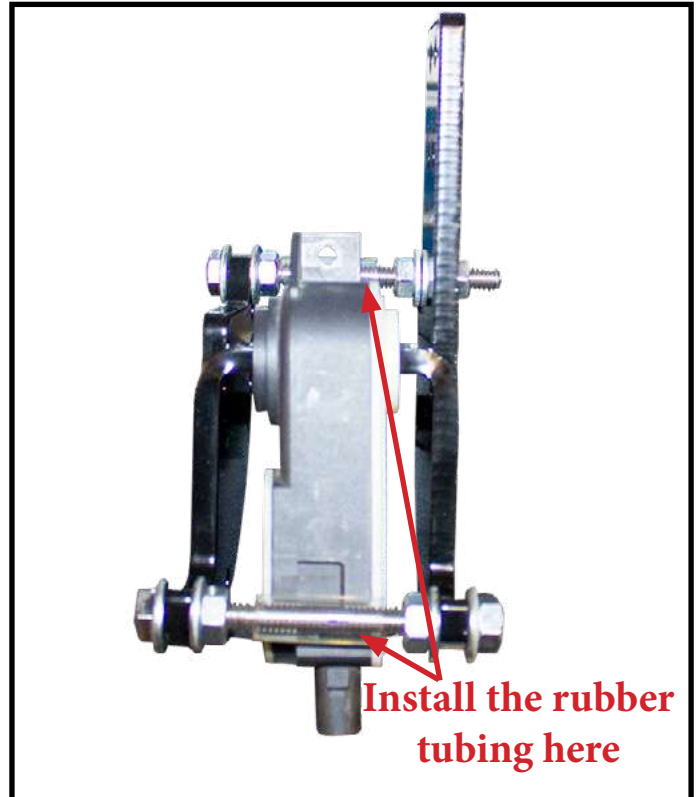
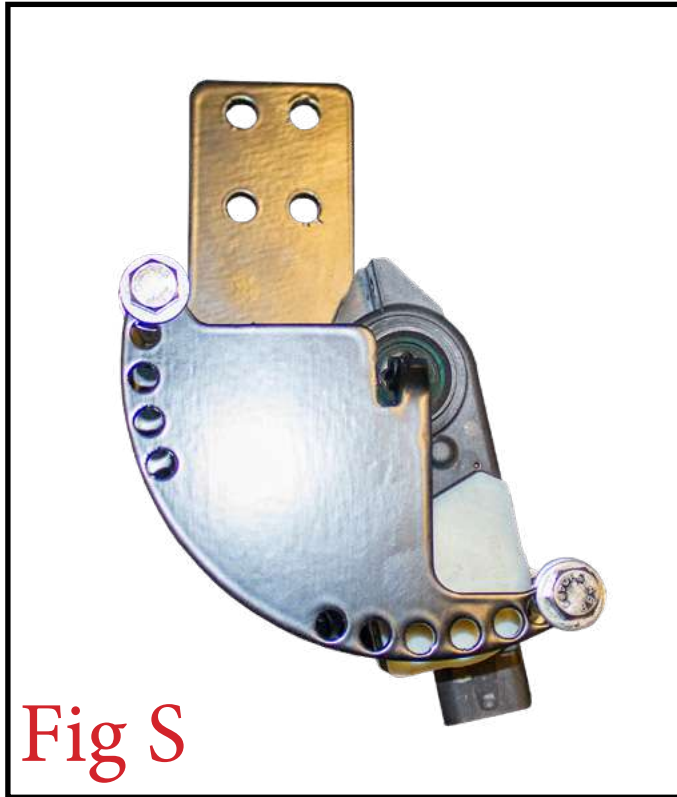
19. Remove the shutter motor from the scoop assembly. (Fig R)



Fig R

Installation:

20. Find the two shutter motor bracket pieces. Then, install the shutter motor into the bracket pieces as shown in (Fig S). **Make sure to use the outer most mounting holes.** Use the supplied 1/4-20 x 3" Bolts (x2), 1/4" Washers (x8), and 1/4-20 Hex Nuts (x6). As you are putting this together, install the supplied rubber tubing onto the bolts.



21. On the driver side of the remaining portion of the intercooler scoop, use a utility knife, or something similar, to trim off the corner following the guide shown in (Fig T).



Cut Along this Line

22. Remove the bolt referenced in (Fig U). Then, put the shutter motor/bracket assembly in place as shown and reinstall that bolt. **The motor will swing within the range of the two mounting bolts. Make sure the wiring is zip tied out of the way, but also allows the shutter motor to move as needed.**



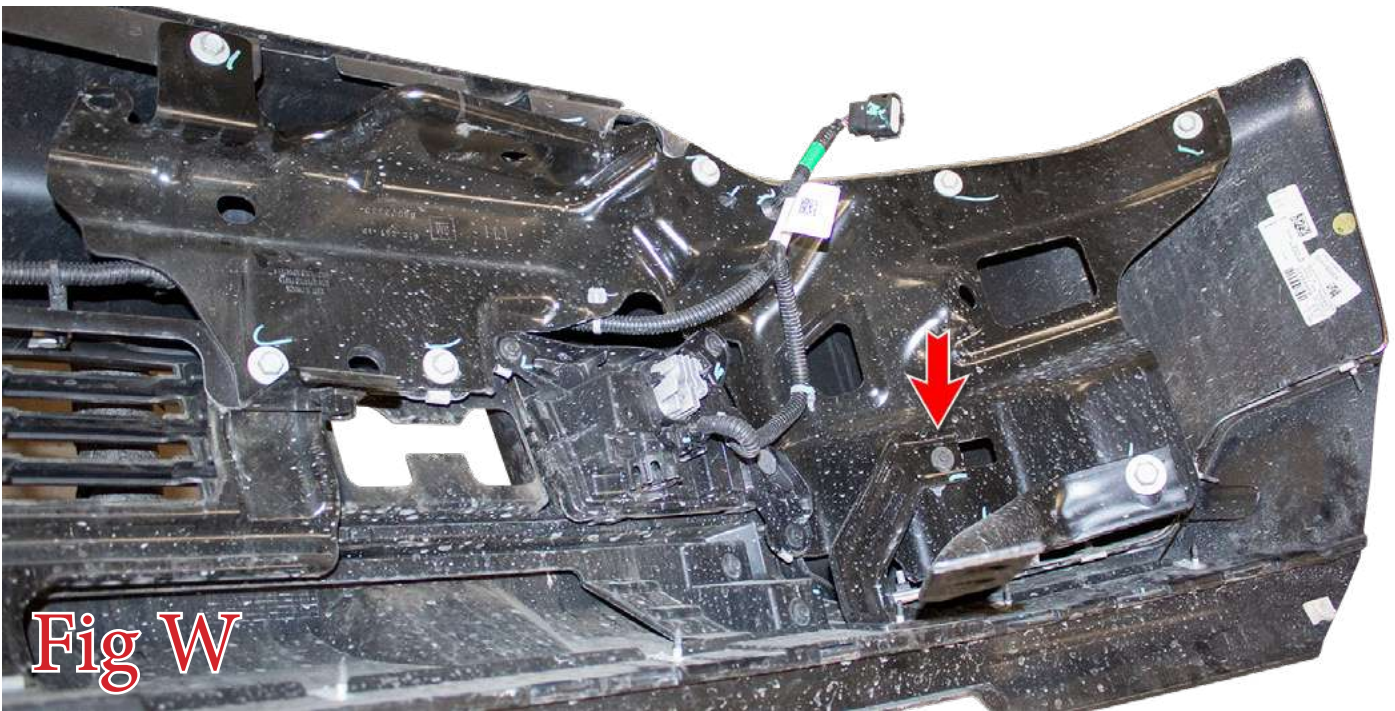
Fig U

23. Reinstall the valances/grille by reversing Steps 1-8. (Fig V)

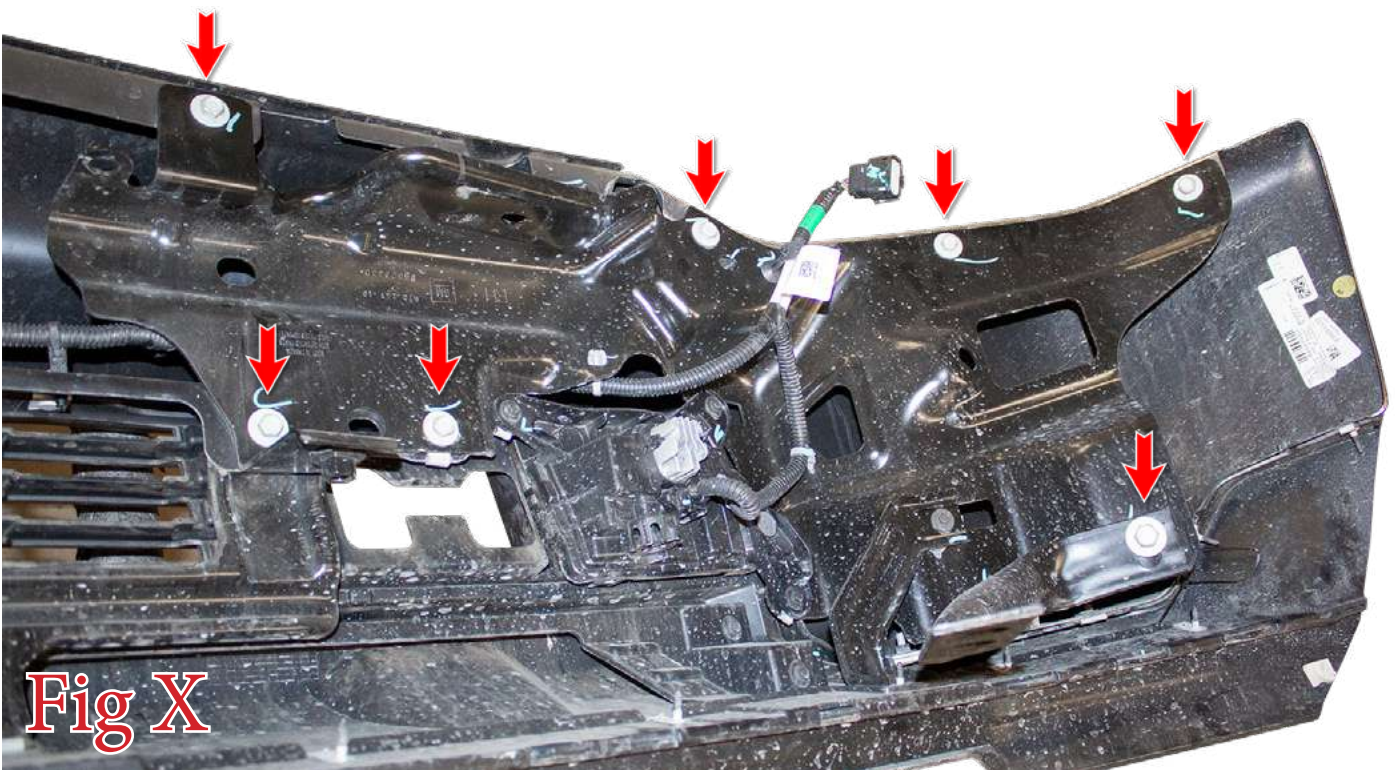


Fig V

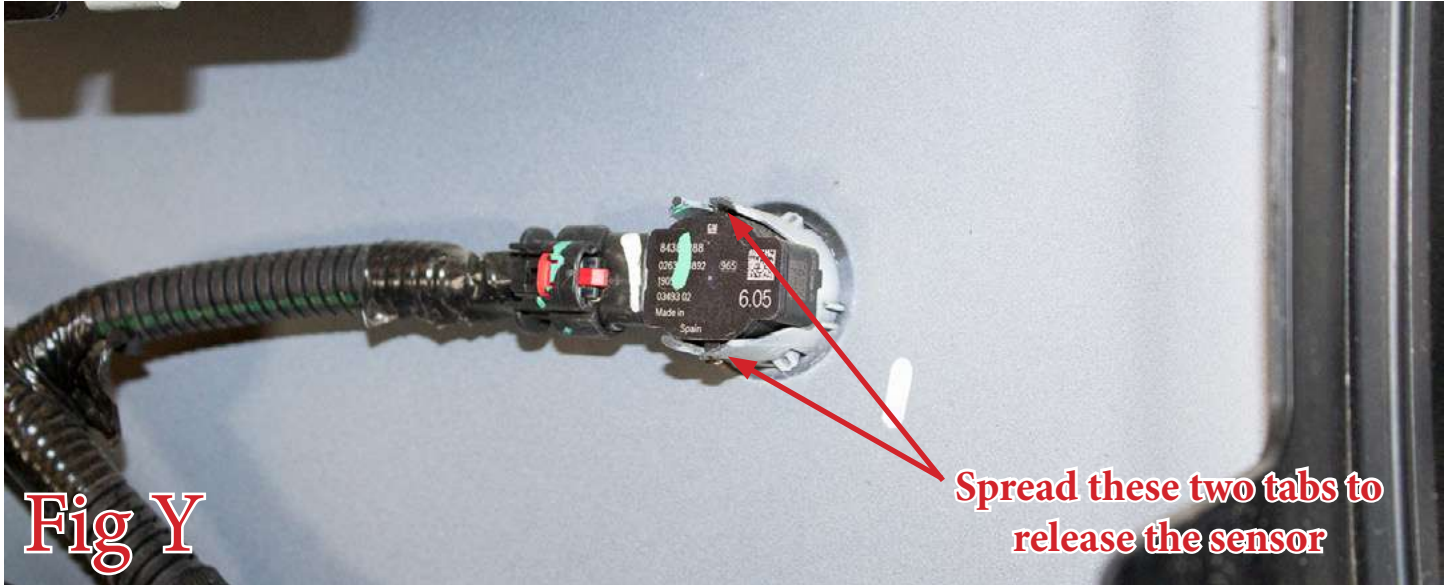
24. With the OEM bumper on a workbench, remove the 7mm bolt (1 per side) that holds the inner structure to the bumper. ()



25. Use a 13mm Socket to remove the mounting bolts (7 per side) that hold in the inner metal structure of the bumper. Then, remove this structure. (Fig X)



26. Remove the parking sensors from their mounting rings. Do this by spreading the two tabs on the back side of the mounting rings and pushing the sensors out the back of the rings. You can leave the sensors plugged into the harness. **Make sure to keep track of what position/orientation the sensors were mounted in so you can keep the same position/orientation on your new bumper.** (Fig Y)



27. Remove the sensor mounting rings from the bumper. Do this by pressing in the tabs on the back side of the rings and pushing the rings out the front side of the bumper. **Make sure to keep track of the position/orientation that these came off the OEM bumper so they can be reinstalled on your new bumper in the same position/orientation.** (Fig Z)



28. Release the series of clips holding the harness to the bumper. Then remove the parking sensor/fog light harness from the bumper. (Fig AA) **Make sure to keep track of the position this was mounted on the OEM bumper so it can be mounted on your new bumper in the same position.**



Fig AA

Installation:

29. Follow this step if you are installing dual light bars. There are three different sets of light tabs with this bumper. Pick the correct tab for your light bar setup (see below). Then, loosely set the tabs in place on the bumper, using the supplied 3/8" Black Button Head Bolts (x4), 3/8" Black Washers (x4), and 3/8" Black Lock Nuts (x4). Dual 40" Tabs will use the outer-most set of holes. Dual 30" Tabs will use the next set of holes inward. With the tabs loosely in place, install the light bars using the light manufacturer's provided hardware. With everything loosely installed, torque the supplied 3/8" hardware to 30 foot pounds. Torque the light manufacturer's hardware to their torque spec. Finally, follow the light manufacturer's guide for wiring information. (Fig AB)

BHD1 - 30" Light Bars (*Rigid or Baja*)

BHD2 - Dual 40" Arc (*Baja Designs*)

BHD3 - Dual 40" RDS (*Rigid*)

Use this set of holes for
dual 30" light tabs

Use this set of holes for dual 40"
light tabs



Fig AB

30. If you are using rounds lights, follow this step. Use the light manufacturer's supplied hardware to mount your lights to your new bumper. For Rigid 360 series lights ONLY, two of the light studs will interfere with the opening for the D-Rings. These two studs will need to be cut shorter using a cutoff wheel or something similar. (Fig AC)

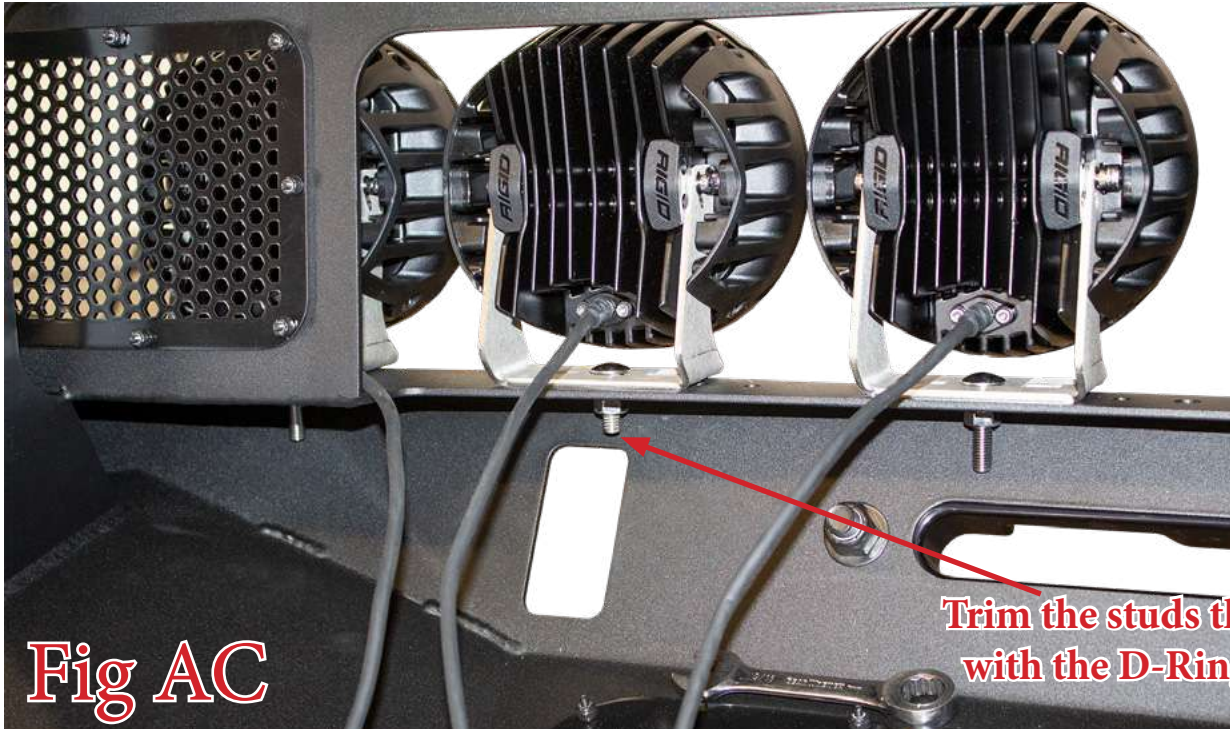


Fig AC

31. Install the Parking Sensor Mounting Rings onto your new bumper. Install them in the same position/orientation as they came off the OEM bumper. If they do not fully click into their holes, you will have to trim back the tabs that hold them in place to account for the thicker material of your new bumper. Do this little at a time, so you don't go too far. (Fig AD)

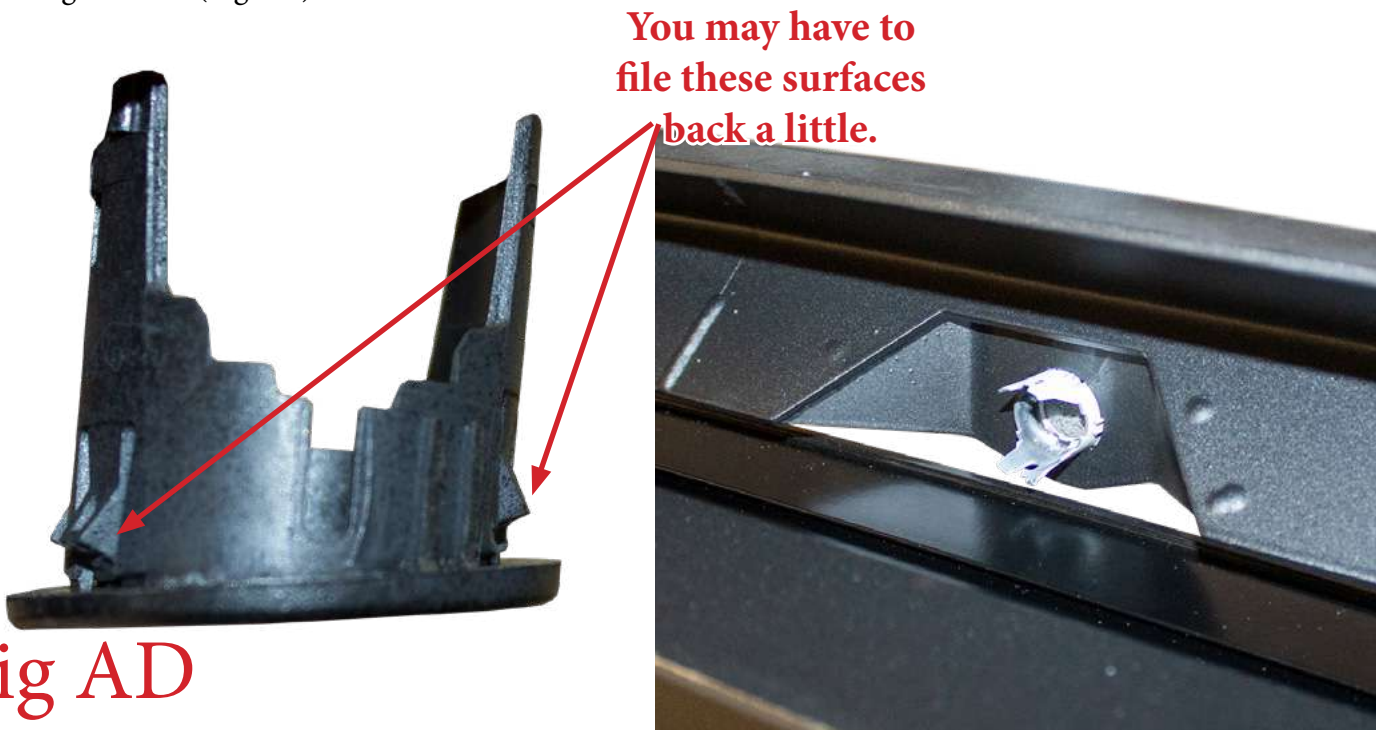
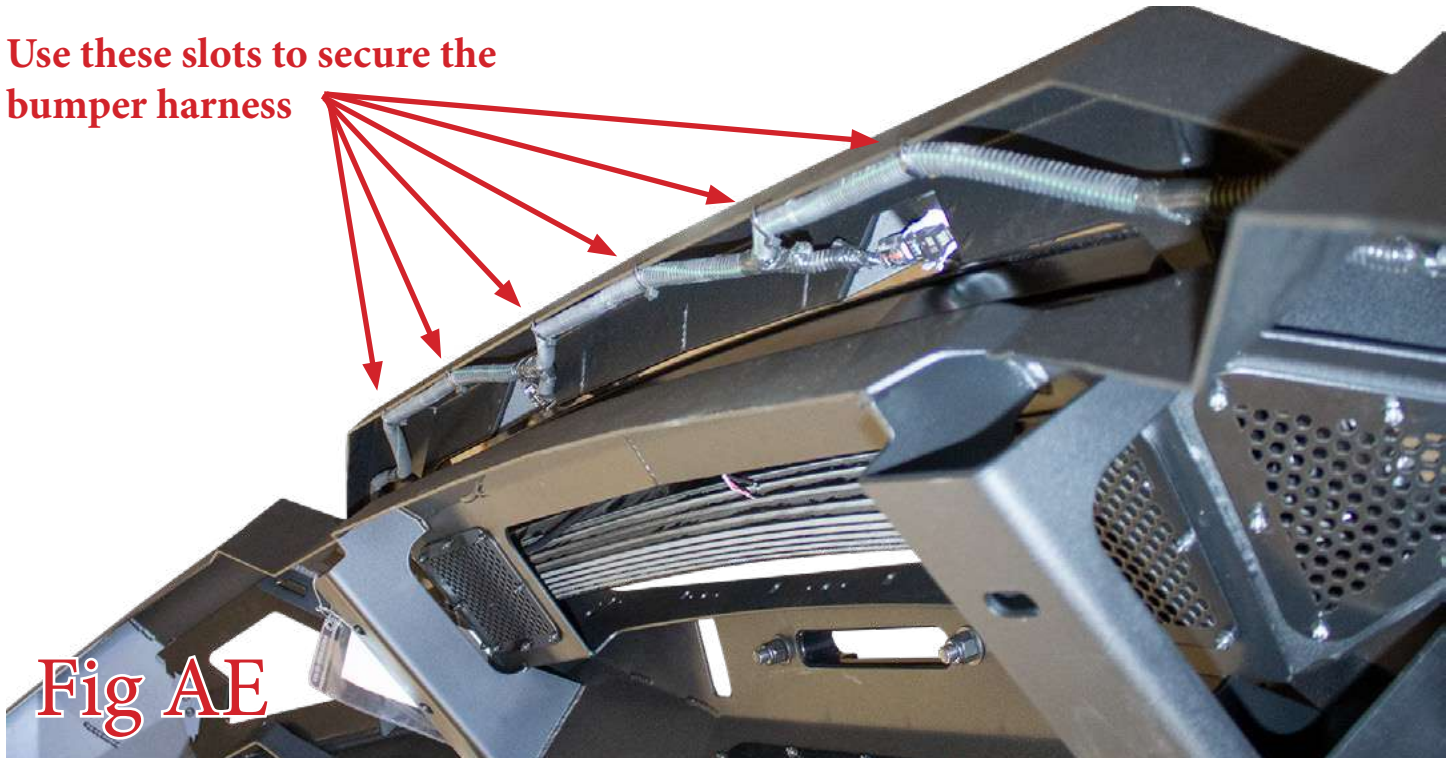


Fig AD

32. Install the parking sensors into their mounting rings. Position the harness as you are installing the parking sensors. Use the slots cut into the top hoop of the bumper as zip-tie points. **Make sure the sensors/harness are installed in the same position/orientation as they came off the OEM bumper.** (Fig AE)

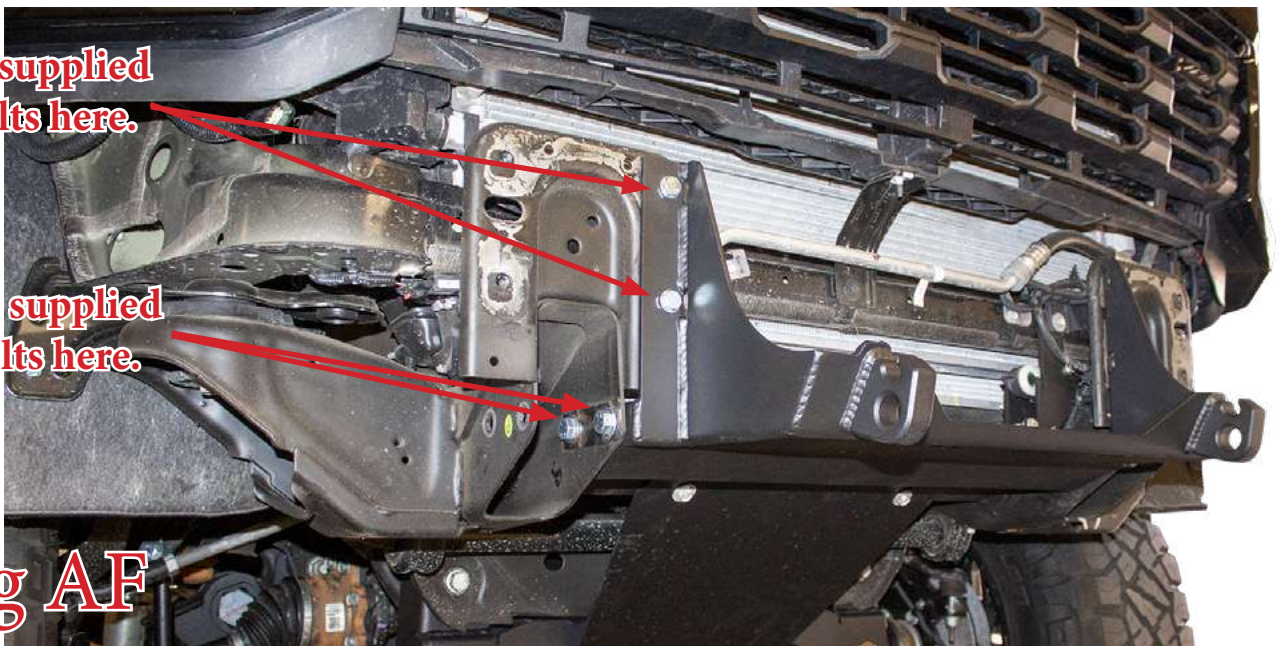
Use these slots to secure the bumper harness



33. Find the supplied Winch Plate. Put the plate in place on the vehicle. Use the supplied M10 Bolts & Washers (x4) as well as the supplied 1/2" Bolts (x4), 1/2" Washers (x8), and 1/2" Lock Nuts (x4) to secure the plate. Once all bolts are loosely installed, torque the M10 bolts to 40 foot pounds, and torque the 1/2" Bolts to 70 foot pounds. (Fig AF)

Use the supplied M10 Bolts here.

Use the supplied 1/2" Bolts here.



34. Install your winch onto the winch plate. Follow the winch manufacturer's installation guide for mounting/wiring information. **Install the winch fairlead onto your bumper at this time as well.** (Fig AG)



Fig AG

35. Set the bumper in place on the vehicle. Use the supplied M10 bolts (x4) and M10 Washers (x4) to secure it. You will have to reach your hand in through the side panel to start the bolts. Once the bolts are all loosely installed, align the bumper so it is straight in relation to the grille/valances, then tighten the bolts to 40 foot pounds. **We recommend putting painters tape on the D-Rings for protection as you install the bumper.** (Fig AH)

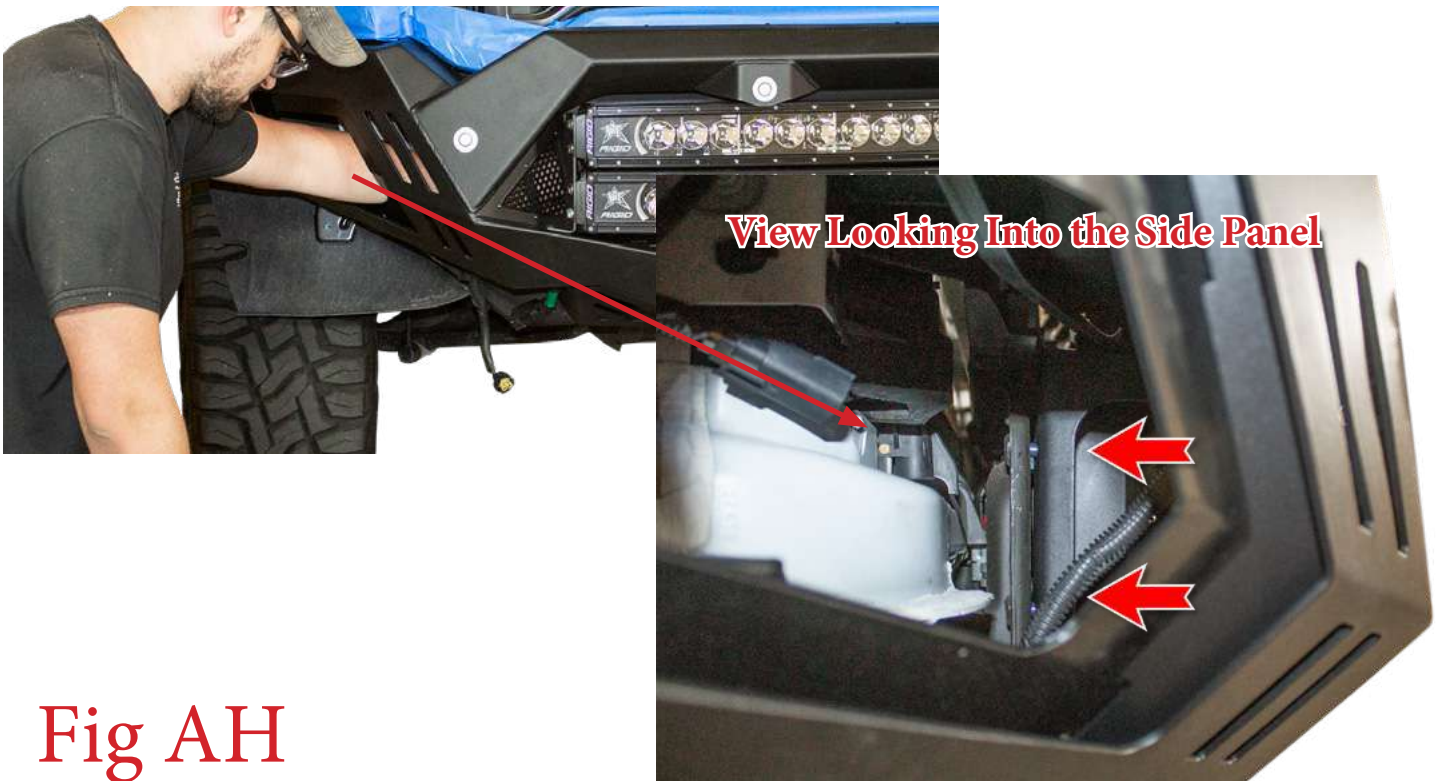


Fig AH

36. Install any cube lights you have for the side panels. Follow the light manufacturer's guide for mounting/wiring information. (Fig AI)



Fig AI

37. Use a T-10 Socket to remove the two lowest inner fender liner bolts in each wheel well. (Fig AJ)



Fig AJ

38. Pull the inner fender liner back to reveal the two bolts holding on the inner liner mounting bracket. Use a 10mm Socket to remove these bolts. Then, remove that bracket from the vehicle. (Fig AK)



Fig AK

39. Use a utility knife, or something similar, to trim the inner fender liners to preference. We suggest following a line similar to what is shown in (Fig AL).



Fig AL

40. Stand back and enjoy your new ADD Bomber™ HD Front Bumper.
41. Check and re-tighten, if needed, all mounting bolts after 100 miles and periodically thereafter.

